

Feasibility Study: Measuring Ruminal Contractions of Cattle Using an Inexpensive Electronic Veterinary Stethoscope

Adam Manaster, Divya Aggarwal, and Yaashnaa Singhal

University of Illinois at Urbana-Champaign

PHYS 398 DLP

May 1, 2020

Table of Contents

Abstract	3
Introduction	3
Materials	6
Schematic and Figures	6
Hardware	10
Methods	11
Software/Data Acquisition	12
Data Analysis	14
Results/Discussion	16
Summary	23
Acknowledgements	23
References	24

Abstract

The effects of gastrointestinal motility in understanding disease and nutrition in cattle has been an active area of research. One methodology for monitoring the health of cattle involves studying contractions of their stomach. Traditional veterinary and electronic stethoscopes are available for these purposes, but can be costly. However, this feasibility study aims to provide graphical data for ruminal contractions in cows by employing an inexpensive electronic microphone with a 3D-printed stethoscope head. This electronic stethoscope was used for data acquisition at the Beef and Sheep Research Field Laboratory located at the University of Illinois at Urbana-Champaign. A second microphone was used to gather background noise. The data from the electronic stethoscope showed distinct peaks in the amplitude graphs that were absent from the background microphone data. Despite extraneous variables, like the physical shifting of the main microphone against the cow and movements of the cow itself, the graphs are strongly suggestive of internal noises from the cow, possibly ruminal contractions. This instrument is promising and presumably could be used by animal nutritionists and veterinarians alike in their research.

Introduction

The makeshift stethoscope we created is intended to measure gastrointestinal noises in a specific compartment of a cow's stomach known as the "rumen." The rumen essentially serves as a fermentation vat in which bacteria and other microorganisms reside. These microbes are capable of breaking down feedstuffs that the cow itself cannot [1]. The goal of this feasibility study is to measure ruminal contractions of large cattle using an electronic stethoscope. The device was developed from an Arduino Mega 2560 microprocessor and electret microphone amplifiers on a printed circuit board, which was programmed using the code from Professor George Golin's code repository on the course website for PHYS 398 DLP at UIUC [7]. The stethoscope head attached to the microphone used for measuring gastrointestinal noises of the cow was 3D-printed using the online software Tinkercad. Two microphones were implemented in the data collection process: one monitored the internal ruminal movement of the cow test subject and the other was used to pick up on environmental background noise in the farm where we collected data.

The synchronized movement of the rumen and reticulum aid in mixing the ingested food and passing it into the omasum (refer to Figure 3). This is done by cyclical contractions of the different chambers of the cow that occur for the reticulum every 50 - 70 seconds. These extrinsic contractions depend on the impulses from the motor nerve traveling in the vagal nerve, maintaining fermentation in the stomach continuously. In the absence of the vagal nerves, the reticulo-rumen muscles undergo low amplitude intrinsic contractions and the gas and feed stagnates in the stomach until the animal dies. [1] A healthy cow undergoes 1-2 ruminal contractions during this time period [2] when heard from a

veterinary stethoscope. Hence, a decrease in the frequency (or amplitude) of contractions is one of the indications that the cow may not be in proper condition. For studying the health of cattle, the primary research method involves surgically cutting a sizable hole in the cow's side and placing a rubber cylinder there in a process known as "cannulation." However, this method is expensive, invasive, and limits the number of cows that can be examined. Electronic stethoscopes (e.g. Whisper) are also available on the market, but their primary purpose is to study lung noises in cattle and they tend to be quite costly. [3] Our study addresses these drawbacks by using a 3D-printed electronic stethoscope that is sensitive enough to measure the movement of the rumen.



Figure 1: The cow that was used as the test subject for the data collection process



Figure 2: A cannulated cow at the research farm

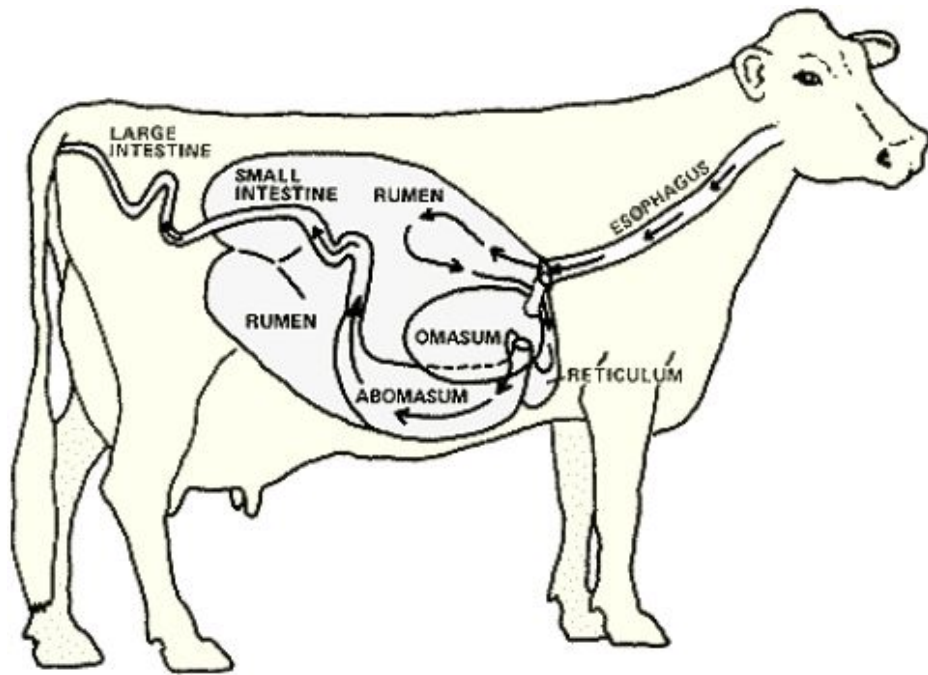

Figure 3: A diagram of the digestive system in a cow

Materials

A. Schematic and Figures

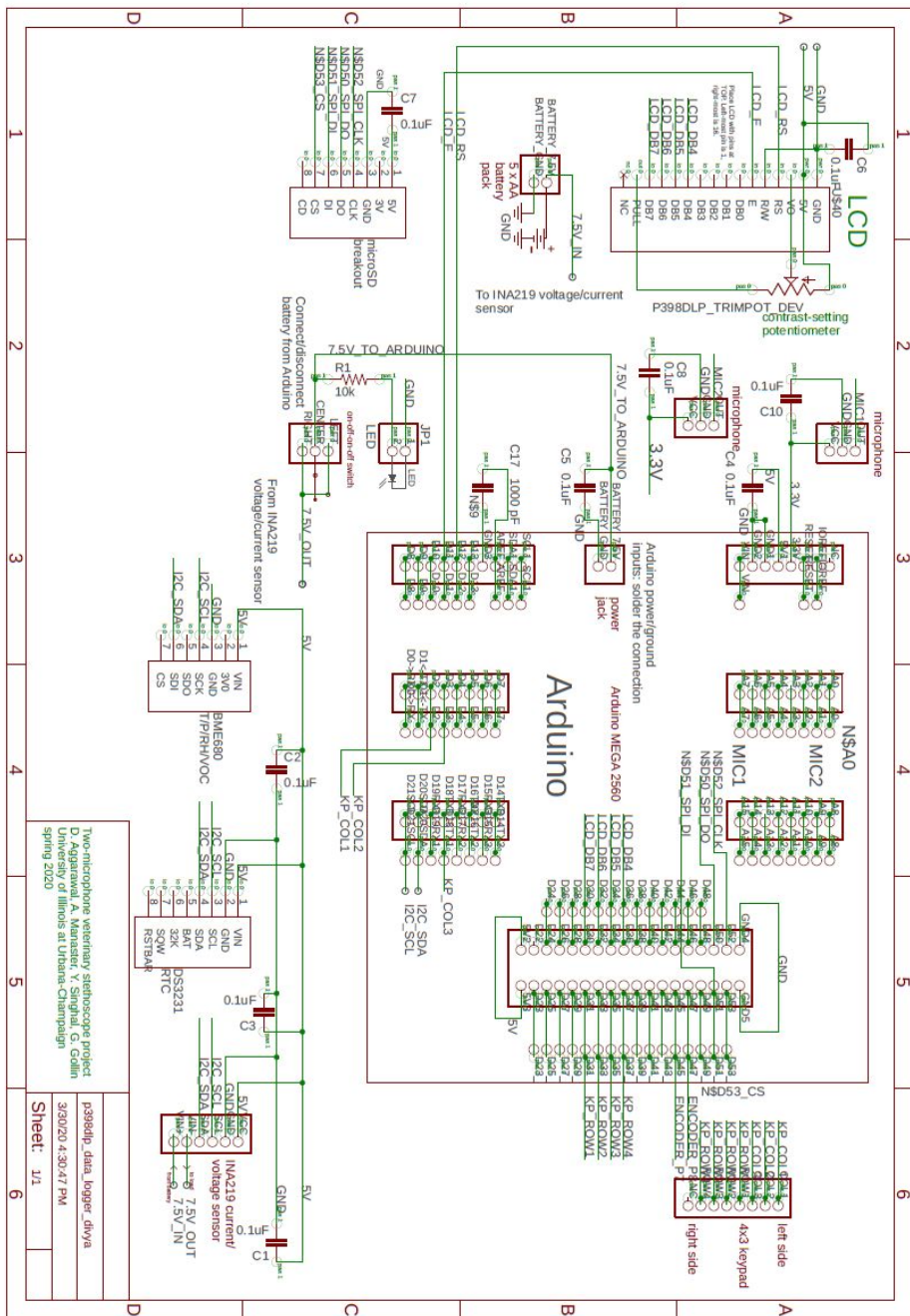

Figure 4: General Schematic of our Printed Circuit Board

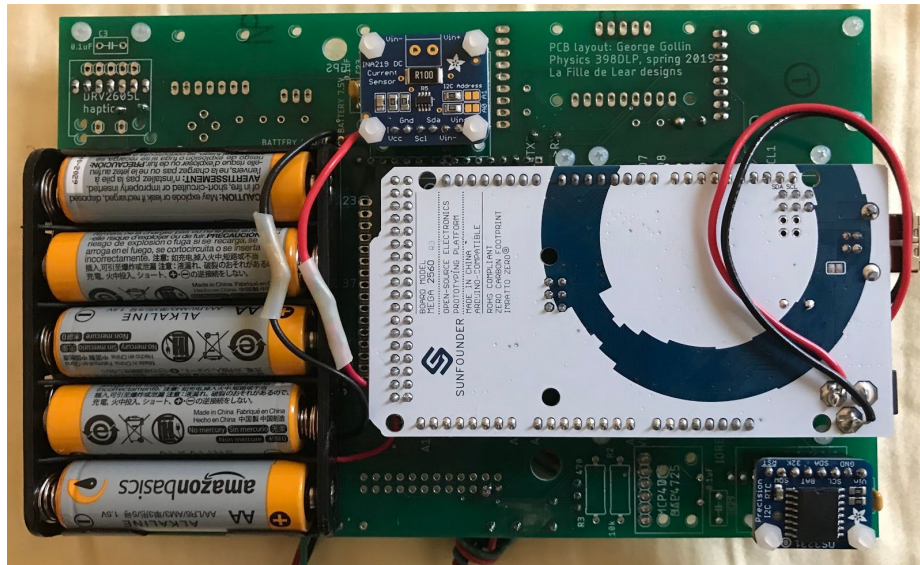

Figure 5: One side of Adam's printed circuit board

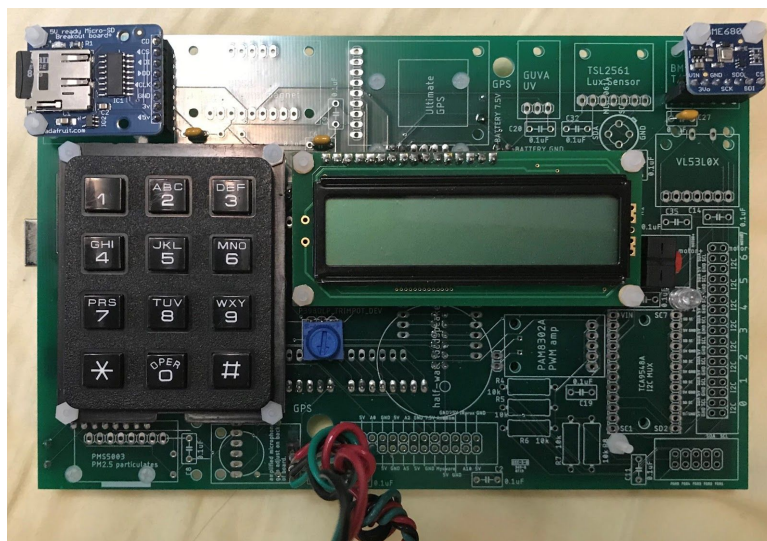

Figure 6: The other side of Adam's printed circuit board



Figure 7: One of the two microphones attached to the printed circuit board using wires



Figure 8: Top view of a 3-D printed stethoscope bell used in the data collection process



Figure 9: Side view of a 3-D printed stethoscope bell

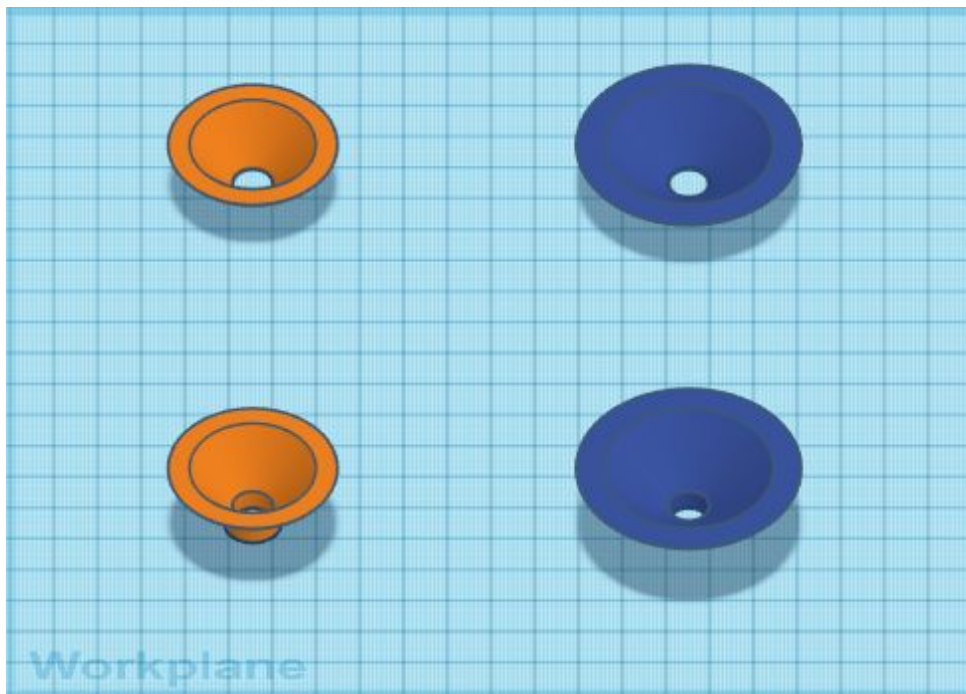

Figure 10: A snippet of the initial stethoscope bell designs in Tinkercad

B. Hardware

We built a test breadboard circuit which included an Arduino Mega 2560 microcontroller and Adafruit breakout boards such as an electret microphone amplifier, BME 680, microSD card, INA219 DC, I2C RTC, LCD, and keypad. The connections were made following Professor George Gollin's schematics (refer to Figure 4). The electret microphone was the primary sensory device for this study. For final testing and data collection, all the components were soldered onto a printed circuit board (PCB) using Professor Gollin's design. An additional microphone was attached to keep track of background noise that would be subtracted out during the post data-processing portion of the project. Significantly less noise/static emanating from the microphones was observed when using the PCB in comparison to the breadboard.

The Arduino Mega 2560 is a high performance microcontroller based on ATmega 2560; it has 54 digital input/output pins, 16 analog inputs, and 4 serial ports. The microphone comes with a 20 Hz - 20 kHz electret microphone soldered on it and built-in trimpot for adjusting the gain from 25x to 125x. It contains a ground port (GND), analog port (A1), and VCC (powered by 3.3V). Two microphones were used which were attached from a series of extended wires to the PCB. Our main microphone (which was connected to ADC channel 7 on the Arduino) had a stethoscope head fixed on it while our background microphone (which was connected to ADC channel 1) was held separately to measure for environmental background noise. The data collected from the microphones was read on the microSD card which used the SPI (Serial Peripheral Interface) protocol to link to the Arduino Mega 2560. The BME 680 was connected to the circuit as a pressure, temperature, and humidity sensor. However, we did not use the data from the BME 680 for this study. The Precision I2C RTC is a real time clock which uses the I2C communication protocol (two wires to communicate). The PCB was powered by a 7.5 V AA battery pack, making it portable to collect data on the field. An interacting Liquid Crystal Display (LCD) and keypad were soldered on the PCB for offline data acquisition. Each member of our team had a fully-functioning breadboard and PCB. However, for data acquisition, we used Adam's PCB.

A comprehensive list of the components on our breadboard and PCB is as follows:

- Arduino Mega 2560
- BME 680
- MicroSD Card
- Keypad
- LCD
- Precision I2C RTC
- INA219 DC Current Sensor
- AA Battery Pack
- Microphone (Main)
- Microphone (Background) (A1, GND, C10 - capacitor for the main microphone)

- Potentiometer
- Capacitors (7 in total)
- Red LED Indicator (to determine whether the PCB was on)
- Button (to turn PCB on and off)
- Resistor

Methods

Initially, we performed several tests with our breadboards and then later with Adam's PCB to record biological sounds from humans, cats (even though this effort was unsuccessful), and a medium-sized dog. The PCB appeared to be much less noisy in terms of the sounds the microphone picked up from the surrounding environment as well as static. A potential reason for this could be that the electrical connection between the microphone and the PCB is much more refined (cleaner) than that of the breadboard. We recorded heart sounds from our human subject, Adam, while he was resting and after he ran multiple laps around Loomis so that we could listen for and compare the microphone's capabilities to detect different heart rates. The cats proved to be too small of a test subject (or perhaps our microphone was not sensitive enough to pick up on any gastrointestinal/respiratory frequencies).

Throughout the semester, our group has been in contact with Professor Joshua McCann, an assistant professor at UIUC within the Department of Animal Sciences. He specializes in the influence of nutrition on metabolism and growth of feedlot cattle by characterizing ruminal fermentation and the gut microbiome. We made plans to go out to the UIUC cattle farm (otherwise known as the Beef and Sheep Field Research Laboratory) to take real data with cows. We took data on Friday (3/13/20), arriving at the farm shortly after 10:00 AM.

We were instructed by a veterinary scientist (Courtney Hayes) who also helped us to place the stethoscope head on the left sublumbar fossa where palpitations are most observable. A clenched fist can be pushed in this area to assess rumen flow. The contractions felt at the left sublumbar fossa can be heard by a stethoscope, which is the most sensitive method of hearing ruminal contractions [8]. Hence, for this study, we chose this region to place the main microphone.

The data were collected for 5-7 minutes. We used this time window so that we could establish some sort of pattern of the major contractions since those typically occur once every minute. Specifically, she said approximately 2-4 contractions every two minutes is to be expected (assuming the cow is healthy). We took four trials of data, but only utilized Trials #2 and #3 because the first trial was to make sure that the instrument was working properly and data from the last trial was taken on a cannulated cow (refer to Figure 2) out of curiosity and thus was not important for our feasibility study. Before taking data, Dr. Hayes helped us pinpoint the location of the rumen (right behind the cow's ribs). While taking data, the stethoscope had to be pushed up forcefully against the cow in order for the instrument to detect the vibrations/churning of the rumen. Because we were able to audibly detect

internal movement of the cow from listening with the standard stethoscope, we are confident that the microphones used in our electronic stethoscope were able to pick up these frequencies as well.



Figure 11: Adam and Yaashnaa taking data at the research farm

Software/Data Acquisition

Our plan for data acquisition involved utilizing two microphones. Because the noises we were attempting to monitor are at a low frequency, we wanted to block out as much background noise and static originating from the microphone as we could in order to ensure that our results were as clear as possible. To accomplish this, we wrote a wav file (the exact process is discussed in great detail later) that subtracted out the ambient noise using the secondary microphone (the one that was not listening for the contractions). This was done to better visualize the sounds we were recording.

We collected data from the microphones which were written and saved onto the microSD card as a singular binary file. We then converted the binary file into a .wav file to process the data in Python. This was done using code Professor George Gollin wrote and edited. Ultimately, we used Python to visualize and analyze our data that was in wav format. After implementing libraries such as LibROSA and SciPy, we were able to begin exploring our data.

The data acquisition program we implemented was written using the Arduino software in the object-oriented programming language C++. The program that we uploaded to our Arduino Mega 2560 (which is connected to the PCB) logs data from two distinct ADC channels to a binary file. Both of these ADC channels house an electret microphone. The sampling rate of each separate channel is 16 kHz (meaning 16,000 samples are recorded per second). The raw ADC count data (which are essentially voltage signals from the microphones numbered from 0 to 1023) are written to buffers (of which there are 13 in total), which are in turn used to write the audio file. Each buffer used in this process can hold 512 bytes of information. Once these buffers are at maximum capacity or the program is stopped, they are written to the output file. This output file is written and subsequently saved to the 8 GB microSD card. The resulting binary file is filled with interleaving data from the two microphones. Basically, one sample is recorded from one of the microphones and written to the buffer and then the next sample is recorded from the other microphone and written to the buffer as well. The process repeats itself until the user manually stops the program. Throughout the process, the user must interact with both the keypad and LCD in order to communicate with the Arduino and tell it when to start and stop recording data.

The first part of our data processing program in Python involves converting the binary audio file into a wav file. A wav file is needed to properly analyze the data in the second part of our data processing program (which is explained later). Although the binary to wav file conversion process may sound technically cumbersome, the underlying methodology is straightforward. Data are read from the binary file with the assumption that the file contains interleaved analog reads of two ADCs. Thus, two distinct arrays are created for the separate channels, where each array contains every other element from the input file. In simpler terms, one array contains the “even” entries while the other array contains the “odd” entries. The median, mean, maximum, minimum, amplitude (with respect to the median), and root-mean-square (RMS) of the arrays are subsequently calculated. The wav file is then created by utilizing the arrays (in conjunction with the aforementioned parameters). Because one of the microphones was being used to pick up on and record environmental background noise (while the other was actually recording the ruminal contractions of the cow), the program “subtracts” out this background noise from that specific microphone when creating the wav file to minimize disturbances in the data. However, before this subtraction occurs, a gain correction factor was applied to the background microphone array. This factor essentially adjusts the sensitivity of the background microphone to match that of the main microphone because the two microphones possessed different gains (meaning they each had different audio input levels, albeit not by much). We calculated the gain correction factor (utilizing Python code) by sampling audio in a silent room and using the data from each microphone to determine the relative ratio of the RMS from both arrays. Also, the raw ADC data had to be centered around zero by subtracting the mean for both of the arrays before the subtraction array was created so that we were minimizing the “spread” of our data without interfering with the nominal values. Once this was accomplished, we were able to move onto the data analysis portion of our feasibility study to determine whether or not our electronic stethoscope was truly able to sense ruminal contractions.

Data Analysis

LibROSA is a Python package used for music and audio analysis. Its primary role can be seen as a music information retrieval system. The first step of the data analysis was to visualize our audio file as an amplitude envelope, which is a visualization of the changes in the amplitude as a function of time. The figure below is one of the amplitude envelopes of Adam's heartbeat in seconds. We can see periodic peaks in the amplitude, which are the heartbeats. We corroborated this by listening to the generated wav file and heard distinct heartbeats that corresponded with the same time stamps as the peaks in the graphs.

Figure 12: Amplitude Envelope of Adam's Heartbeat

Next, we plotted a spectrogram using LibROSA as well. A spectrogram is a visual representation of the spectrum of frequencies of a sample audio as it varies with time. It can be seen as a heat map of the varying frequencies in different colors. We changed the y-axis (which represents the frequencies) to a logarithmic axis to better visualize the range of the frequencies. This was also done to better identify the sounds we were recording through their respective frequencies. The unit of time is in seconds for the x-axis in Figures 13 and 14.

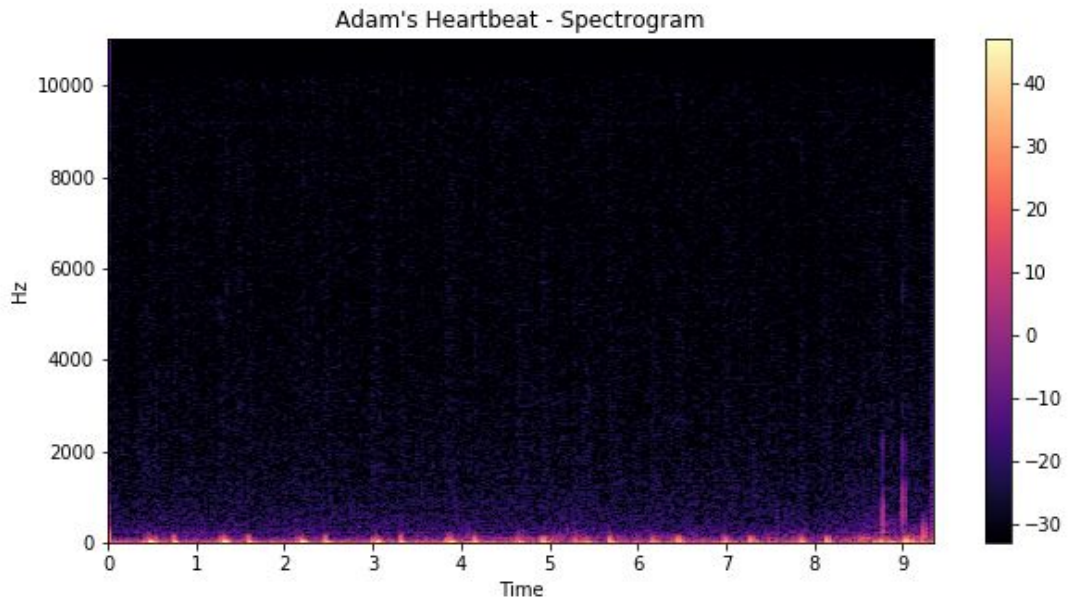

Figure 13: Spectrogram of Adam's Heartbeat

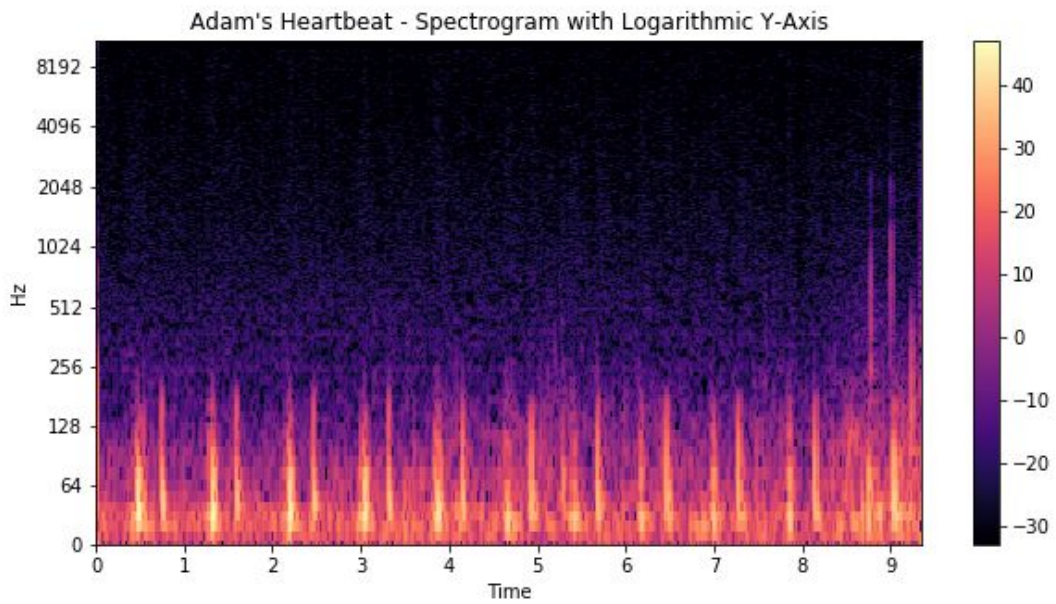

Figure 14: Spectrogram of Adam's Heartbeat (Logarithmic Y-Axis)

Results/Discussion

We used the data analysis methods detailed in the section above on the audio files we collected from our field visit. Figures 15 and 16 (below) showcase the results of the entirety of Trials #2 and #3, respectively. The ADC count data (which are the voltage signals picked up by the microphones and centered around 0) were plotted on the y-axis, whereas the sample number was plotted on the x-axis (which is essentially “time,” considering how 16,000 samples were collected every second per channel). Both the main microphone and background microphone were plotted in the same figure to illustrate the relation between the two and the signals that they registered. It is important to note that the background microphone dataset was adjusted for the differences in the gain between both microphones (using the gain correction factor, as previously discussed). Sudden spikes in both of the plots likely indicate the presence of loud environmental noises at a given point in time in the barn where data were being collected. However, jumps in solely the main microphone readings imply that the noise it picked up either came from moving the microphone on the cow’s stomach during the data-taking process or internal noises from the cow. Audio samples via smartphone were taken concurrently with the electronic stethoscope to verify whether these spikes in the main microphone dataset are attributed to the internal ruminal movement of the cow test subject. Upon further inspection, we deduced that some of these noises must have come from the cow, as we could audibly detect and thus rule out which noises were attributed to the shuffling of the main microphone. The low-frequency “vibrations” (being a faint churning or gurgling sound) were almost certainly indicative of internal noises from the cow. The largest spikes in the dataset, however, were most often attributed to the sudden shifting of the cow or the stethoscope bell rubbing up against the cow. It is also important to mention that people must use the appropriate audio equipment (e.g. high-quality headphones or speakers) in order to hear any of the noises from the .wav files due to how quiet they are.

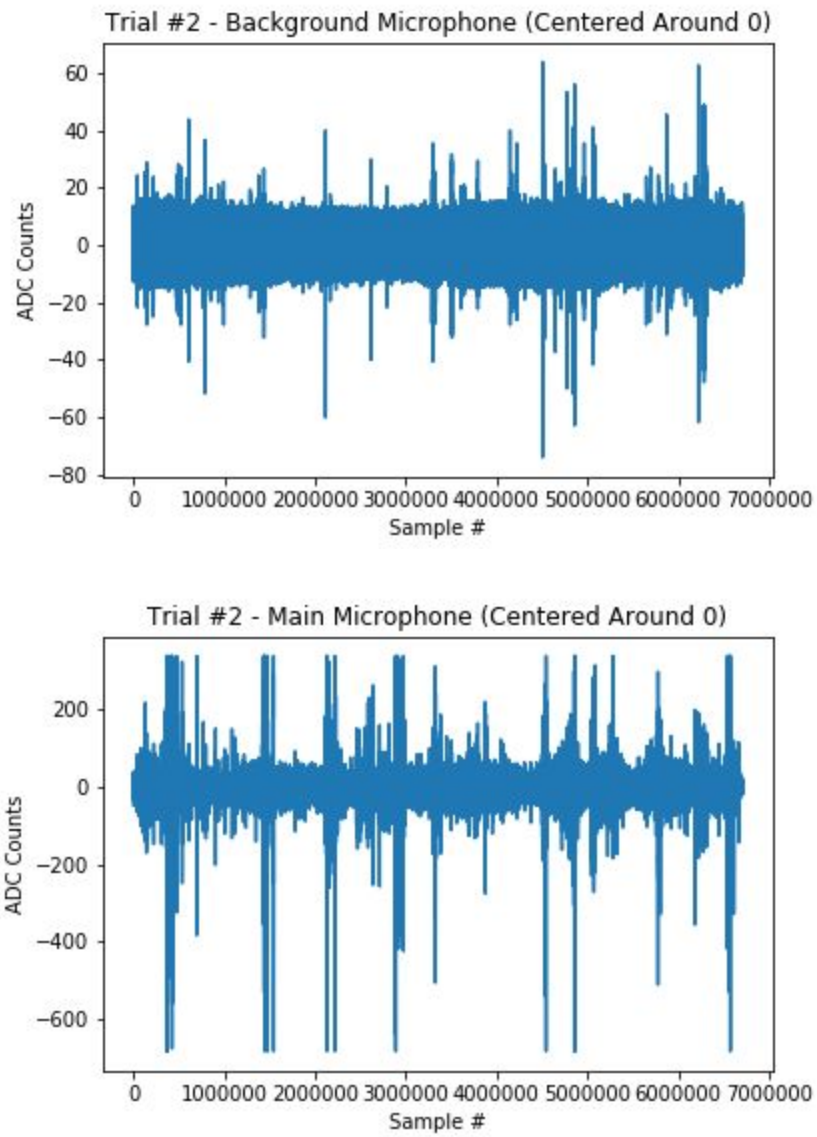

Figure 15: ADC Count Data (Centered Around 0) for Both Microphones - Trial #2

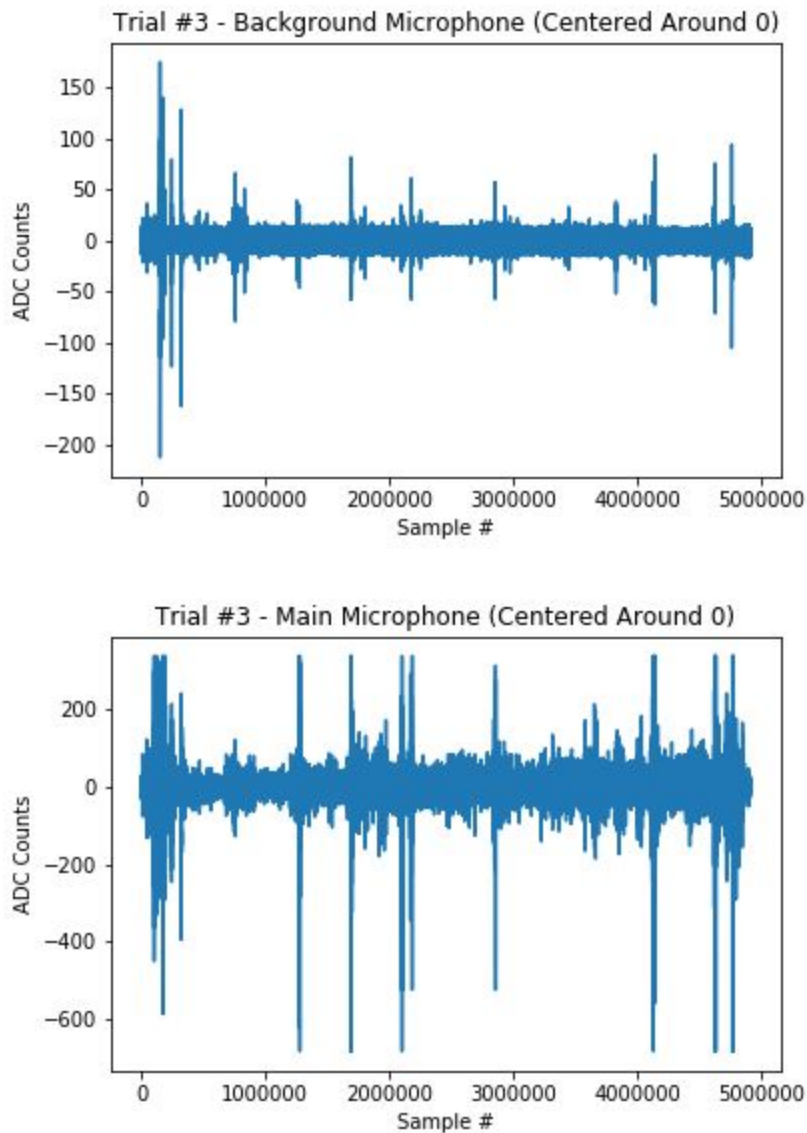

Figure 16: ADC Count Data (Centered Around 0) for Both Microphones - Trial #3

The following set of graphs are the amplitude envelopes of the “subtraction” audio files for both Trial #2 and #3. We hoped to reduce the ambient sounds in the recording from the main microphone to better visualize the internal sounds from the cow. The areas circled in red in the figures below are points in time where potential contractions may have been occurring. These regions encompass a relatively broad expanse of time because there is uncertainty surrounding exactly which “spikes” in the amplitude envelope are due to these potential contractions. The specific regions were chosen based on the premise that the wav files presented sounds at lower frequencies that seemed to be representative of churning/gurgling “vibrations,” which are the types of internal noises one would expect to hear from a cow as its rumen actively contracts. As previously mentioned, the most intense spikes in the dataset are usually (but not always) attributed to external (rather than internal) movement of the cow.

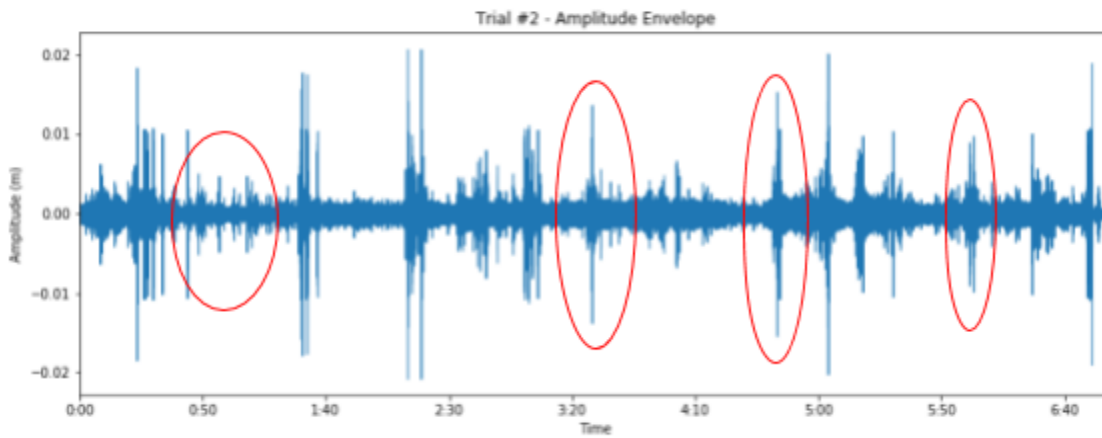

Figure 17: Amplitude Envelope of the Subtraction File for Trial #2

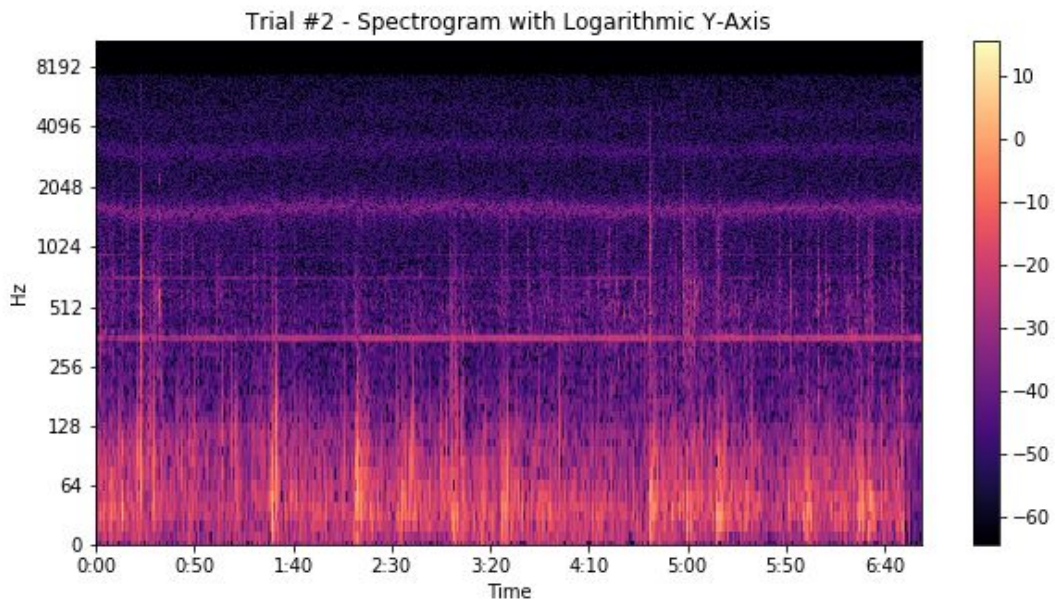

Figure 18: Spectrogram of the Subtraction File for Trial #2 (Logarithmic Y-Axis)

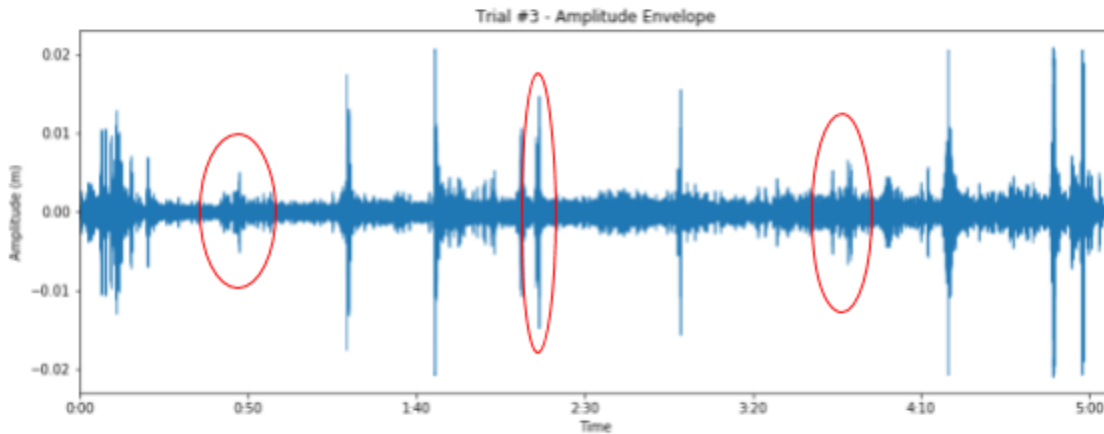

Figure 19: Amplitude Envelope of the Subtraction File for Trial #3

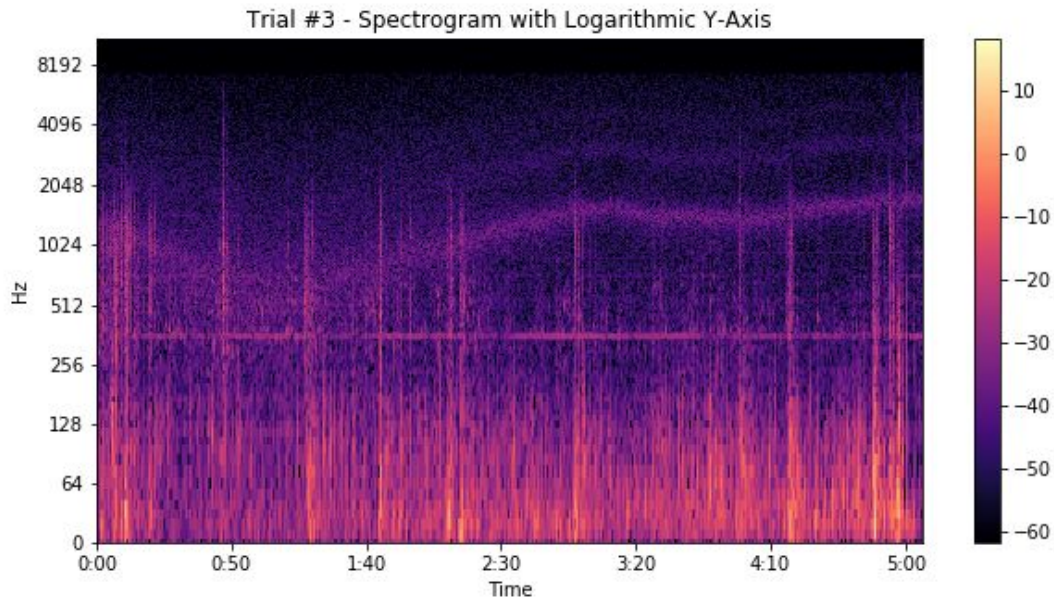

Figure 20: Spectrogram of the Subtraction File for Trial #3 (Logarithmic Y-Axis)

Figures 17 and 19 show the amplitude envelopes of the subtraction audio files (generated using LibROSA) for both Trials #2 and #3, respectively. To reiterate, the term “subtraction” refers to how the (corrected) ADC data from the background microphone array was subtracted out from the (raw) ADC data from the main microphone array using **numpy** in Python. Again, “corrected” implies adjustment of the background microphone’s gain and “raw” implies no manipulation of the main microphone dataset. The frequency of the signal is plotted (in Hz) on the y-axis, whereas time is plotted on the x-axis. After accounting for the environmental background noise, it appears the main microphone of our electronic stethoscope was able to sense internal movement of the cow. There is a slight,

discernable pattern in both of these figures that hint at the possibility of contractions occurring; although, it is still not apparent whether or not this “pattern” is being established at regular intervals, as our amplitude data appears to be fairly noisy despite manipulating the audio signals by subtracting out the ambient noise/static in the barn. Some of the “peaks” in the circled regions are more subtle; these are where potential contractions are occurring (after closely monitoring the wav files for each trial). Also, while the spectrograms in Figures 18 and 20 provide insight into what frequencies were being measured by the microphones, there is no singular characteristic frequency that is indicative of a ruminal contraction. However, these setbacks are to be expected, as the components used to craft our instrument were not of the highest quality. Overall, the data being presented in these figures is promising but not conclusive of ruminal contractions.

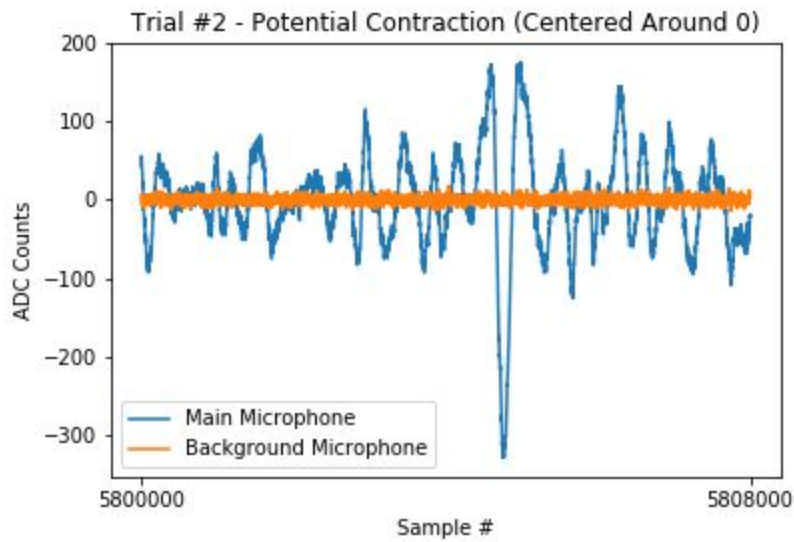

Figure 21: ADC Count Data (Centered Around 0) - Potential Contraction (Trial #2)

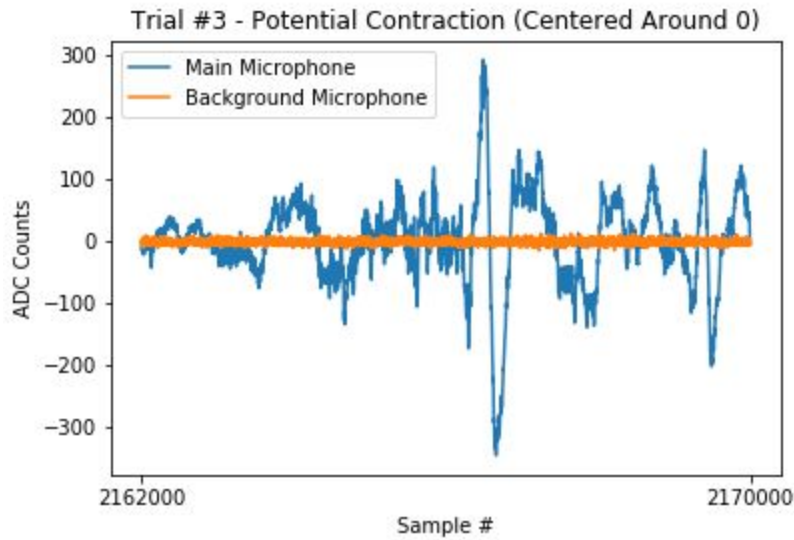

Figure 22: ADC Count Data (Centered Around 0) - Potential Contraction (Trial #3)

Figures 21 and 22 highlight $\frac{1}{2}$ second of data, corresponding to 8,000 samples, from Trials #2 and #3 (respectively). These plots show the relation between the audio signals sensed by the background microphone (after adjusting its gain level using the methodology described in the “Software/Data Acquisition” section of the report) and main microphone during periods of time where a potential ruminal contraction was occurring. Figure 21 depicts audible movement just after the 6:00 mark for Trial #2 whereas Figure 22 depicts audible movement at around the 2:15 mark for Trial #3. The sinusoidal-like wave of the main microphone data heavily suggests there is some internal movement in the cow, especially in direct comparison to the background microphone data. There are other occurrences of these potential contractions in the data, but only one contraction was chosen from each trial as a representative snapshot for this report. As previously mentioned, the two microphones are inherently offset by a small amount of time because data is read from the microphones one at a time. To account and correct for this minor discrepancy, consecutive values in the generated background microphone array were averaged to yield values that were directly comparable to values in the existing main microphone array. Two consecutive samples from the background data array were averaged and compared with consecutive samples from the main microphone to account for the time bin offset. This process was only applied to the graphs in Figures 19 and 20 because the time offset between the two microphones is negligible, seeing as how each concurrent sample was taken within $\frac{1}{16,000}$ th of a second of the other microphone. We also did not take into account lag between the two microphones due to the speed of sound because this effect was negligible as well (the two microphones were positioned within a couple of feet from one another).

Summary

Utilizing our electronic veterinary stethoscope, as well as data processing software in Python, we were able to collect and analyze audio samples that are strongly suggestive of ruminal contractions in our cow test subject. The data plotted from the main microphone, which was placed near the rumen of the cow, showed distinct peaks that were not present in the background microphone dataset (refer to Figures 19 and 20). Supplementary audio recordings from a smartphone also did not pick up on any background noise for the time periods where distinct spikes in the amplitude profiles were observed. However, further studies can be performed to discern ruminal contractions with other noises that the cow may be making (both externally and internally). Adding another microphone to collect gastrointestinal noises from the cow and comparing data gathered from both of them versus the background microphone might be more conclusive. Additionally, the gain levels of the background microphone and main microphone need to be more fine-tuned in order to eliminate any offset.

Acknowledgements

We would like to acknowledge Dr. Joshua McCann for teaching us about the science behind the ruminal contractions of cattle, setting up our visit to the research farm, and his willingness to provide aid for us throughout this process. We would also like to acknowledge Courtney Hayes for her assistance in helping us determine the optimal way to take data while at the research farm, and we would like to acknowledge Cody Dawson and Leon Peters for their assistance in showing us around the research farm and gathering the cattle. Lastly, we would like to extend our gratitude to Professor George Gollin, Justin Languido, and Charlie Steiner for providing us with the proper resources and knowledge to successfully complete this project.

References

- [1] Ruckebusch Y., Motility of Gastro-Intestinal Tract
- [2] Bruno R., Jordan E., Hernandez-Rivera J., Lager K. (2011). The Basic Clinical Exam: Key to Early Identification of Sick Animals (p. 4). Retrieved from URL
<https://agrifecdn.tamu.edu/texasdairymatters/files/2011/08/Basic-Clinical-ExamFS.pdf>
- [3] Whisper Electronic Stethoscope: <https://www.merck-animal-health-usa.com/whisper>
- [4] Adafruit Electret Microphone: <https://www.adafruit.com/product/1063>
- [5] LibRosa Python Package: <https://librosa.github.io/librosa/>
- [6] I. G. Rush (2009). Rumen Physiology for the Rancher. Retrieved from URL
<https://beef.unl.edu/beefreports/symp-2009-28-xxi.shtml>
- [7] PHYS 398 DLP Spring 2020: <https://courses.physics.illinois.edu/phys398DLP/sp2020/code.asp>
- [8] Clinical examination of the abdomen in adult cattle by