

Lab Assignment #11: Detail Drawings

ME170

Instructor: Mike Philpott (email: mphilpot@illinois.edu)

Date Due: One week from Start Day of Lab (turn in deadline – 11pm night before next lab)

Part 0. File Verification.

Verify that the following four files are in your working directory. If they are missing or outdated, download ME170_Base.zip from Lab 1, extract the ZIP file, and copy a new version of the files to your working directory.

170dwgconfig.dtl
mechse_mm_part.frm
170modeltree.cfg
config.pro

Part I. Configure Creo for Drawing Creation

You will prepare Creo for drawing creation with the following instructions.

- Open Creo Parametric 5.0 from the Start Menu.
- Set your working directory.
- Select "File" → "Options."
- Click "Configuration Editor" at the bottom of the column on the left.
- Click "Import/Export" → "Import configuration file" at the bottom right corner of the "Options" window.
- Select the "config.pro" file in your working directory.
- Click "Open". Click OK. Click "No".
- Numerous settings have just been applied to your Creo session. Import this file each time you start working in Creo to ensure that your future parts and drawings have the correct settings. Consult the "Parameter Changes" files for a complete list of changes.



Part II. Complete Exercise 16 (pg 375-384)

The goal of this exercise is create detail drawings.

Pay particular attention to the notes below. Our instructions for this exercise deviate regularly and significantly from the book's instructions.

Task 1

- Remember to include your netid in the drawing file name. It is a common convention to give a drawing the same file name as the part it depicts.
- **Use the 'mechse_mm_part.frm' format instead of the book's 'b.frm' format. If you started with the wrong format you can change it in the sheet setup options. With the "Layout" tab/ribbon selected, click on sheet setup. Select the sheet you want to change the format on and click on the format. A drop down appears with a number of options, click "Browse" and navigate to your format. A popup will appear asking if you want to delete formatted tables. Click the "remove" button under the single format table text to remove them all. This might require more than one click. If any are left just delete them after.**
- **Ensure your drawing config file(170dwgconfig.dtl) is loaded. This file sets specific drawing parameters that are needed to recreate example drawings. Go to File > Prepare > Drawing Properties > Change detail options > Open (file folder symbol near the top) > Browse to 170dwgconfig.dtl > Open > Press OK to accept changes > Press OK to popup box if one appears.**
- Set the sheet scale to '2:1'. Double click the scale in the bottom left-hand corner of the screen (image below). Enter '2' in the prompt and click the green checkmark to confirm the scale change.



- Turn off all datum plane, axis, and coordinate system visibility. Navigate to the "View" ribbon (image below). Deselect all of the visibility buttons. Note that the new configuration file automatically enabled visibility for all datum features. Default datum visibility is useful when modeling parts. However, datum features should be hidden when creating drawings.

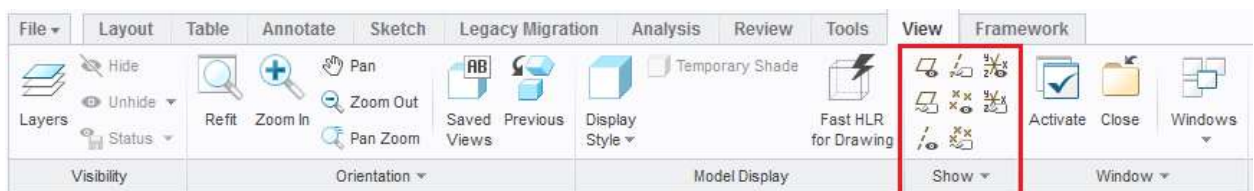

Task 2

- The repaint button is in the small toolbar directly below the main ribbon.

Task 4

- Enter a new scale value of '5'. The drawing sheet that the book uses (11x17) is twice the size of an 8.5x11. For future scale adjustments, use half of the book's recommend value.

Task 5

- You must click the "Select all" button in the "Show Model Annotations" window in order to show all the dimensions (image below).

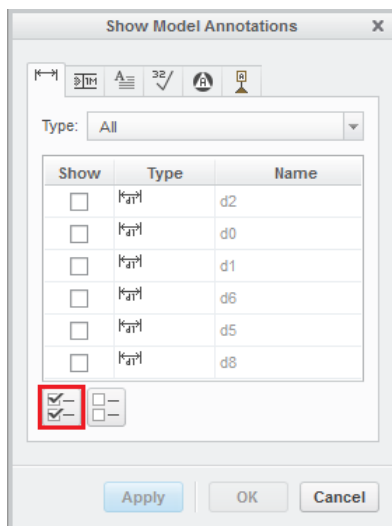
Task 6

- These drawing options have already been set in your drawing setup file. You do not need to complete this task.

Task 7

- Click the middle mouse button after you have drawn a box around all of the dimensions.
- Use appropriate offset and increment values. These values should be large enough such that dimension text does not overlap with part outlines or other text, yet small enough that there is not excessive space between dimensions. Your offset and increment values should be consistent throughout your drawing. The default values of '0.375' and '0.250' should provide a good starting point.

Task 8

- Use the drawings included in this lab instruction document as a guide instead of the drawings in Appendix B. You may not be able to move the chamfer dimension at this time. At the end of this exercise, your drawings should match those shown in this

instruction document. The drawings show in this document have been adapted from Appendix B to fit the ME 170 drawing format. Additional, helpful instructions and pointers are included after these task notes.

Task 10

- Create the note and then delete it. This task provides good practice for creating notes. However, the note is unnecessary. List the material as "LEXAN" in the title block.

Task 11

- Create the symbol and then delete it. The symbol is unnecessary. However, it is good practice for adding a symbol.

Task 12

- Only create drawings for netid_4455-001, netid_4455-002, netid_4455-003, and netid_4455-006.
- Your drawings should match the drawings shown at the end of these lab instructions.
- Ensure that your dimensions, tolerances, notes, and view locations match the drawings shown at the end of these lab instructions. You will be graded on the accuracy of your drawing. Ignore discrepancies in Exercise 16. You may need to delete or recreate features created in Exercise 16.
- Helpful drawing tips and printing instructions can be found in the "Drawing Tips" document on the course webpage.

Part III. Complete Exercise 17 (pg 386-392)

In this exercise you will complete part 4455-005.

Part IV. Lab Submission Requirements

- 1) Create a zip file named "<netid>_lab11.zip" with the following files. Submit it for grading through the my.mechse website. Be sure to include the latest version of each part AND drawing.

Ensure that your views are set to "hidden line". We will not be grading off for the wrong "tangent edge display" setting, but do your best to match the reference drawings.

IMPORTANT: A drawing file references the model file which it depicts. Both the drawing file AND the model file must be in the same directory for the drawing file to open and display correctly. Be sure to submit both files when submitting drawing assignments.

netid_4455-001.prt.#
netid_4455-001.drw.#
netid_4455-001.pdf

netid_4455-002.prt.#
netid_4455-002.drw.#
netid_4455-002.pdf

netid_4455-003.prt.#
netid_4455-003.drw.#
netid_4455-003.pdf

netid_4455-006.prt.#
netid_4455-006.drw.#
netid_4455-006.pdf

netid_4455-005.prt.# (from Part III)

1 2 3 4 5 6

A

A

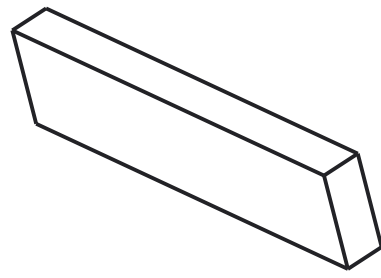
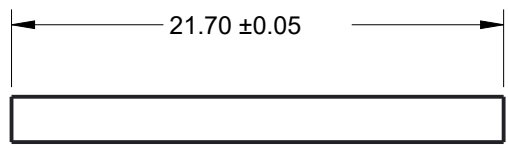

B

B



2.00 ± 0.05

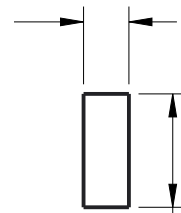

5.00 ± 0.02

C

C

D

D

| | |
|--|--------------------|
| Mechanical Science and Engineering University of Illinois: Urbana-Champaign | |
| ME 170 | Part Name: |
| 09/13/2016 | Connector Vertical |
| Size: A | Material: |
| Scale: 3:1 | PVC/RUBBER |
| Team | Drawn By: |
| 5 | Michael Philpott |
| Sheet | Part Number: |
| 1 of 1 | 4455-001 |

Units: mm
 General Tolerance ±.25
 UNLESS OTHERWISE STATED

1 2 3 4 5 6

A

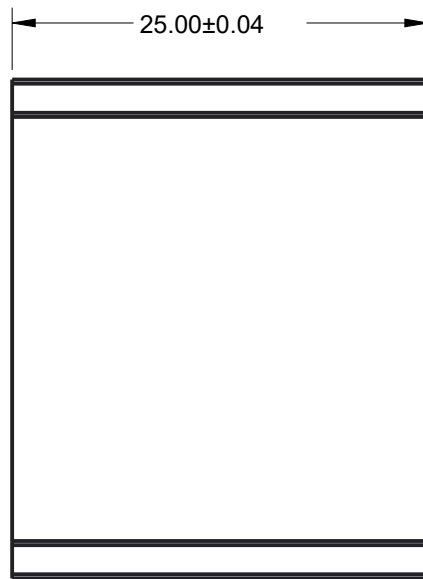

30.00 ± 0.04

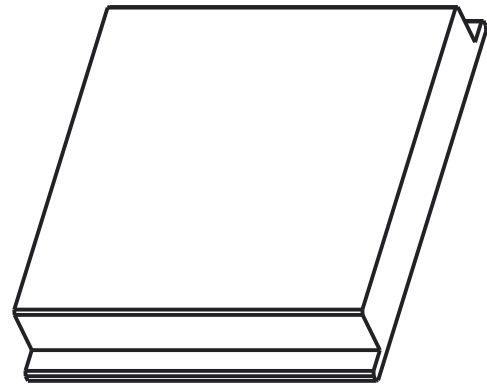

B

C

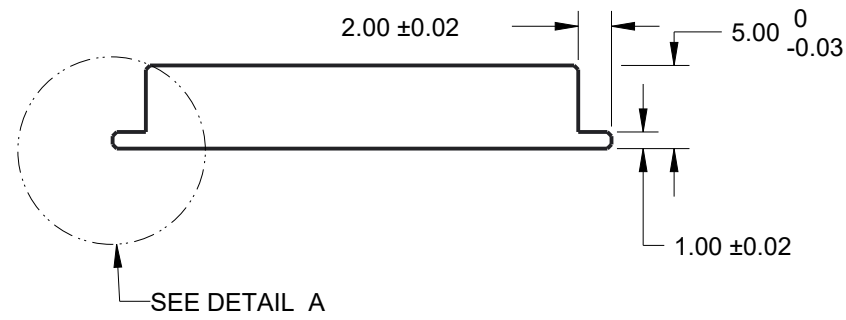

SEE DETAIL A

0.25x45°
6 PLC

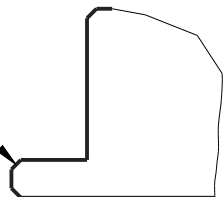

DETAIL A
SCALE 5:1

D

| | |
|--|---------------------------|
| Mechanical Science and Engineering University of Illinois: Urbana-Champaign | |
| ME 170 | Part Name: |
| 09/13/2016 | Display, Small Electronic |
| Size: A | Material: |
| Scale: 2:1 | Lexan, CLR |
| Team | Drawn By: |
| 5 | Michael Philpott |
| Sheet | Part Number: |
| 1 of 1 | 4455-002 |

Units: mm
General Tolerance ±.25
UNLESS OTHERWISE STATED

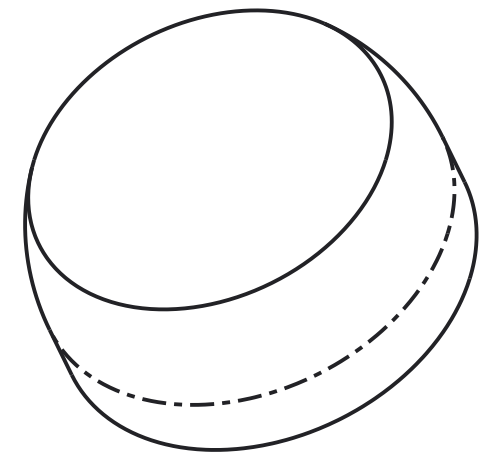
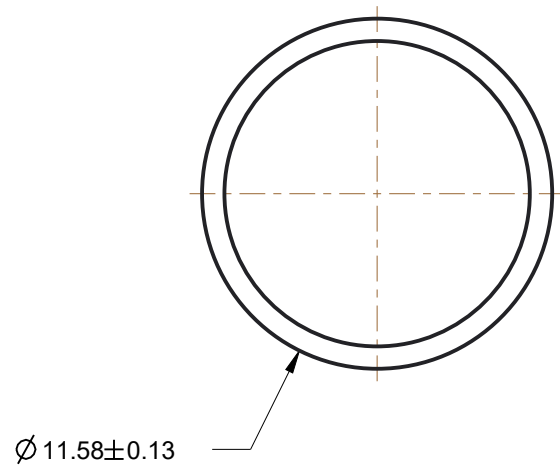

SCALE 5:1

VENDOR: DURACELL

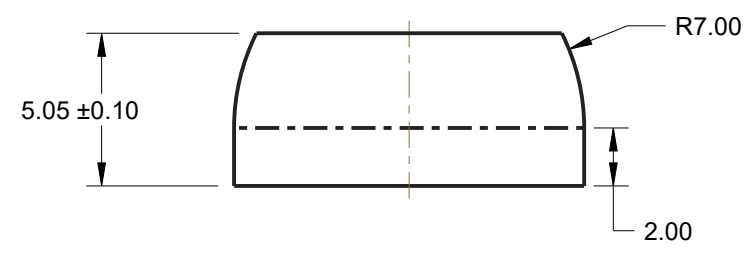

| | |
|--|---------------------------|
| Mechanical Science and Engineering University of Illinois: Urbana-Champaign | |
| ME170 | Part Name: |
| 09/13/2016 | Battery, Small Electronic |
| Size: A | Material: |
| Scale: 4:1 | N/A |
| Team | Drawn By: |
| 5 | Michael Philpott |
| Sheet | Part Number: |
| 1 of 1 | 4455-003 |

| |
|---|
| Units: mm |
| General Tolerance ±.25 UNLESS OTHERWISE STATED |

A

A

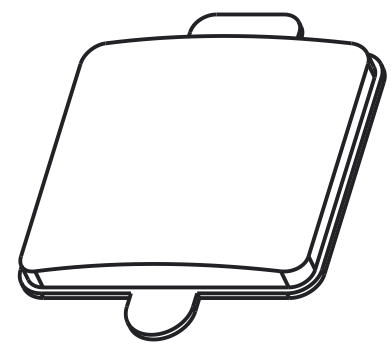
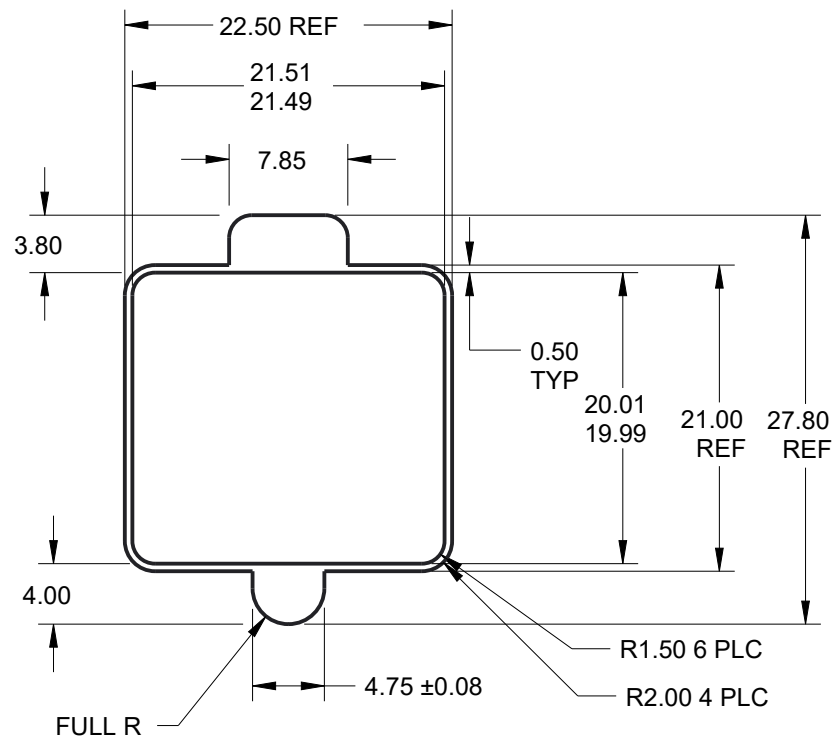

B

B

C

C

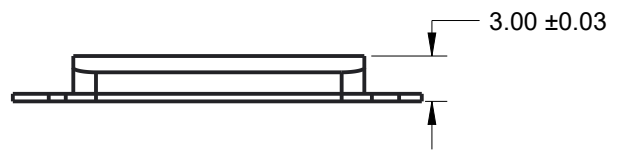
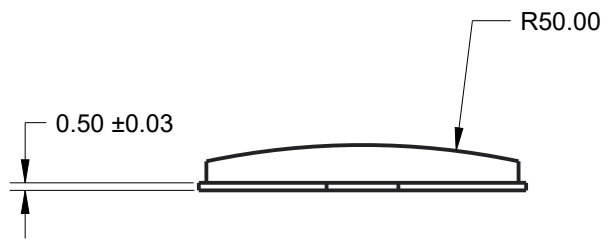

D

D

| | |
|--|------------------------|
| Mechanical Science and Engineering University of Illinois: Urbana-Champaign | |
| ME170 | Part Name: |
| 09/13/2016 | Lens, Small Electronic |
| Size: A | Material: |
| Scale: 2:1 | Lexan, CLR |
| Team | Drawn By: |
| 5 | Michael Philpott |
| Sheet | Part Number: |
| 1 of 1 | 4455-006 |

Units: mm
General Tolerance ±.25
UNLESS OTHERWISE STATED