

CS/ECE 439: Wireless Networking

MAC Layer – Multi-Rate

What is “Data Rate” really?

- ▶ Number of bits that you transmit per unit time
 - ▶ under a fixed energy budget

- ▶ Too many bits/s
 - ▶ Each bit has little energy -> Hi BER

- ▶ Too few bits/s
 - ▶ Less BER but lower throughput



802.11b – Transmission rates

- ▶ Optimal rate depends on SINR
 - ▶ i.e., interference and current channel conditions

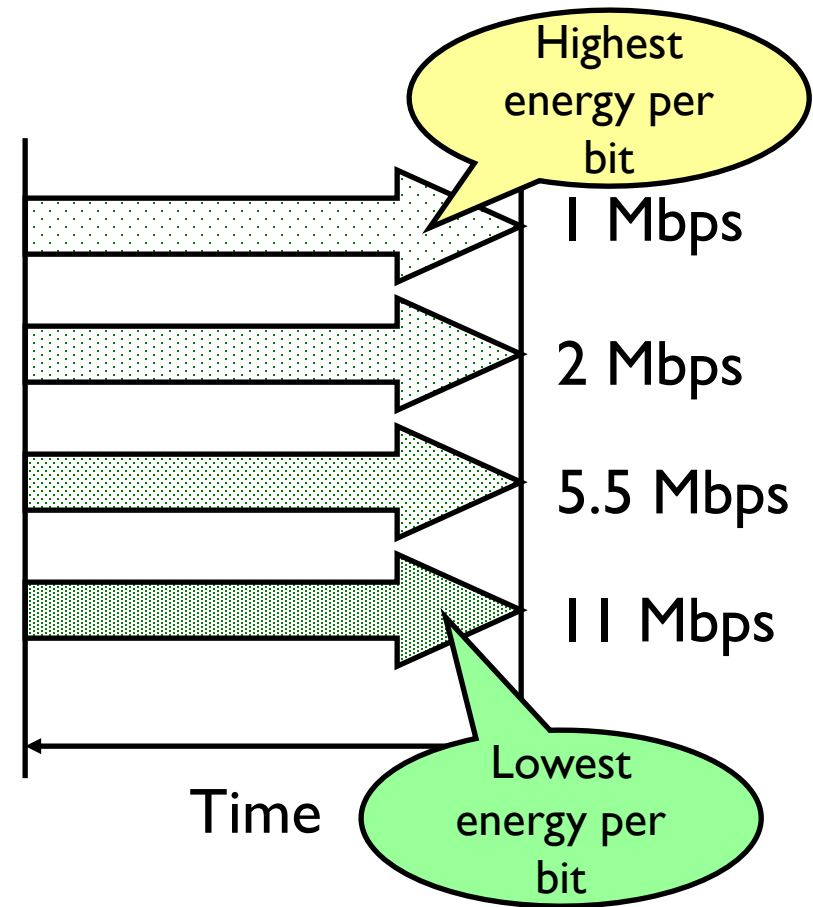

What is Multi-Rate?

- ▶ Ability of a wireless card to automatically operate at several different bit-rates
 - ▶ (e.g. 1, 2, 5.5, and 11 Mbps for 802.11b)
- ▶ Part of many existing wireless standards
 - ▶ (802.11b, 802.11a, 802.11g, HiperLAN2...)
- ▶ Virtually every wireless card in use today employs multi-rate



Example Carrier Modulations

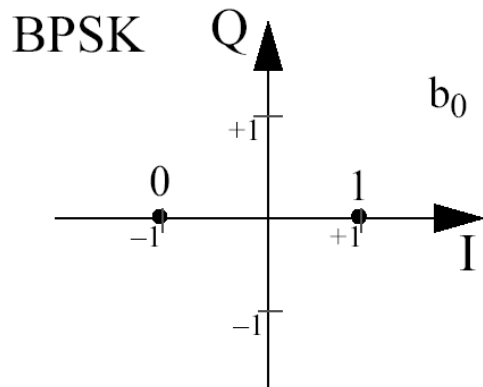

- ▶ Binary Phase Shift Keying
 - ▶ One bit per symbol
 - ▶ Made by the carrier and its inverse

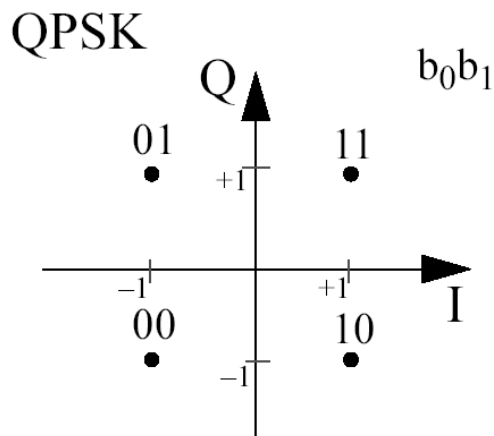

- ▶ Quadrature Phase Shift Keying
 - ▶ Two bits per symbol
 - ▶ Uses quadrature carrier in addition to normal carrier
 - ▶ (90° phase shift of carrier)
 - ▶ 4 permutations for the inverse or not of the two carriers

Example Carrier Modulations (cont.)

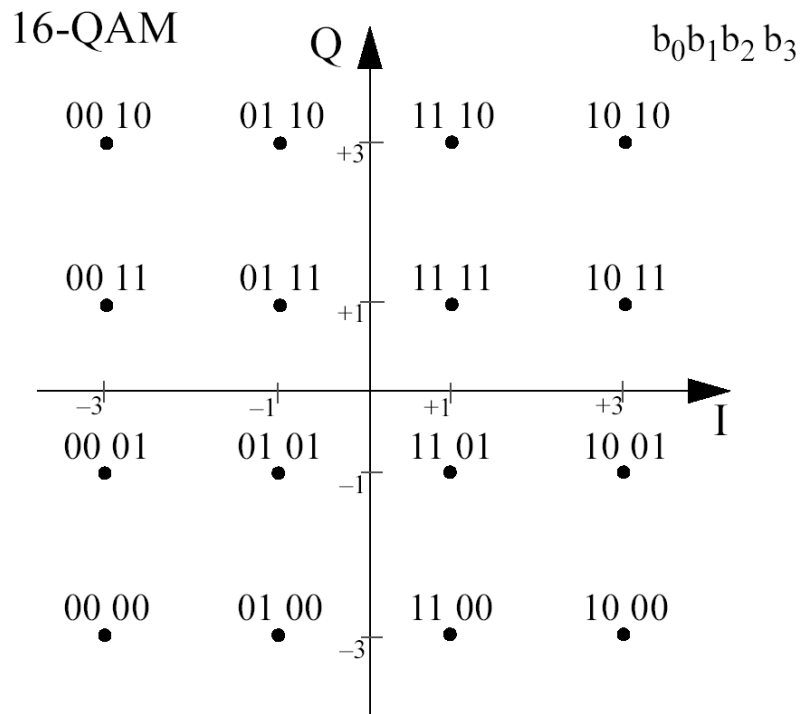

- ▶ 16 - Quadrature Amplitude Modulation
 - ▶ 4 bits per symbol
 - ▶ Also uses quadrature carrier
 - ▶ Each carrier is multiplied by +3, +1, -1, or -3
 - ▶ (amplitude modulation)
 - ▶ 16 possible combinations of the two multiplied carriers



Example Carrier Modulations (cont.)

▶ 64 - Quadrature Amplitude Modulation

- ▶ 6 bits per symbol
- ▶ Also uses quadrature carrier
- ▶ Each carrier is multiplied by +7, +5, +3, +1, -1, -3, -5, or -7 (amplitude modulation)
- ▶ 64 possible combinations of the two multiplied carriers

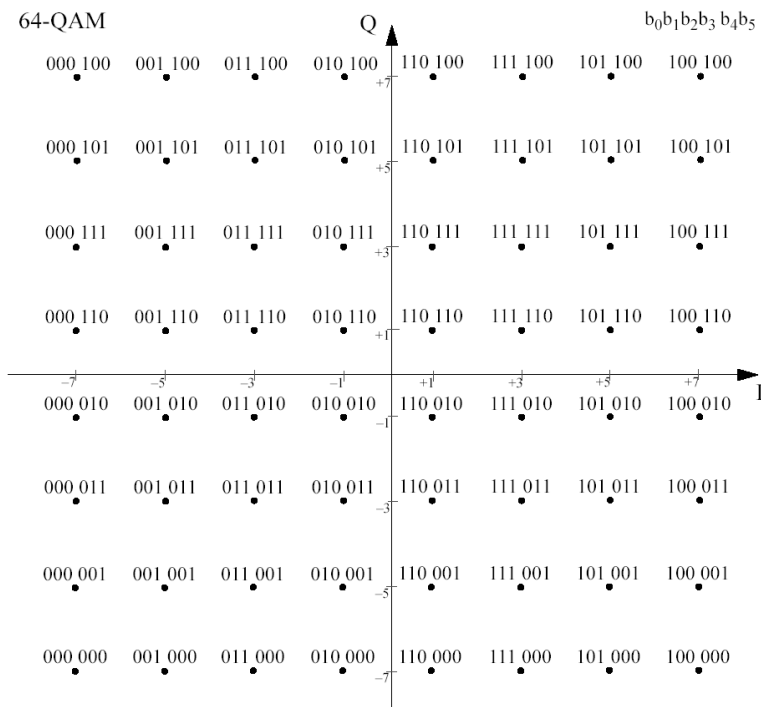

802.11a Rates resulting from Carrier Modulation and Coding

Data rate (Mbits/s)	Modulation	Coding rate (R)	Coded bits per subcarrier (N_{BPSC})	Coded bits per OFDM symbol (N_{CBPS})	Data bits per OFDM symbol (N_{DBPS})
6	BPSK	1/2	1	48	24
9	BPSK	3/4	1	48	36
12	QPSK	1/2	2	96	48
18	QPSK	3/4	2	96	72
24	16-QAM	1/2	4	192	96
36	16-QAM	3/4	4	192	144
48	64-QAM	2/3	6	288	192
54	64-QAM	3/4	6	288	216



Advantage of Multi-Rate?

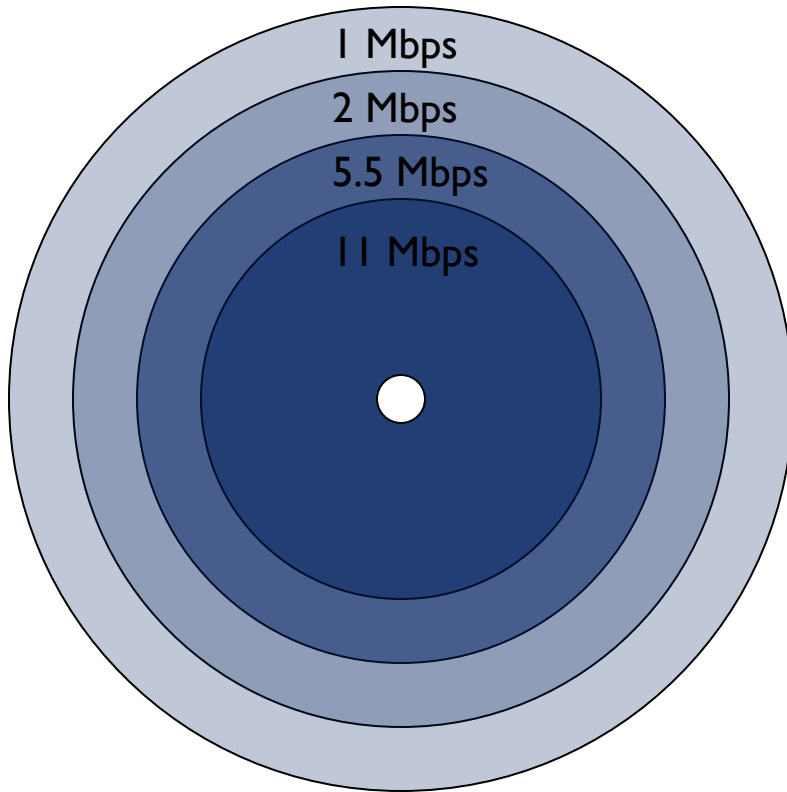

- ▶ Direct relationship between communication rate and the channel quality required for that rate
- ▶ As distance increases, channel quality decreases
 - ▶ Tradeoff between communication range and link speed
- ▶ Multi-rate provides flexibility to meet both consumer demands



Throughput vs. Distance for 802.11a

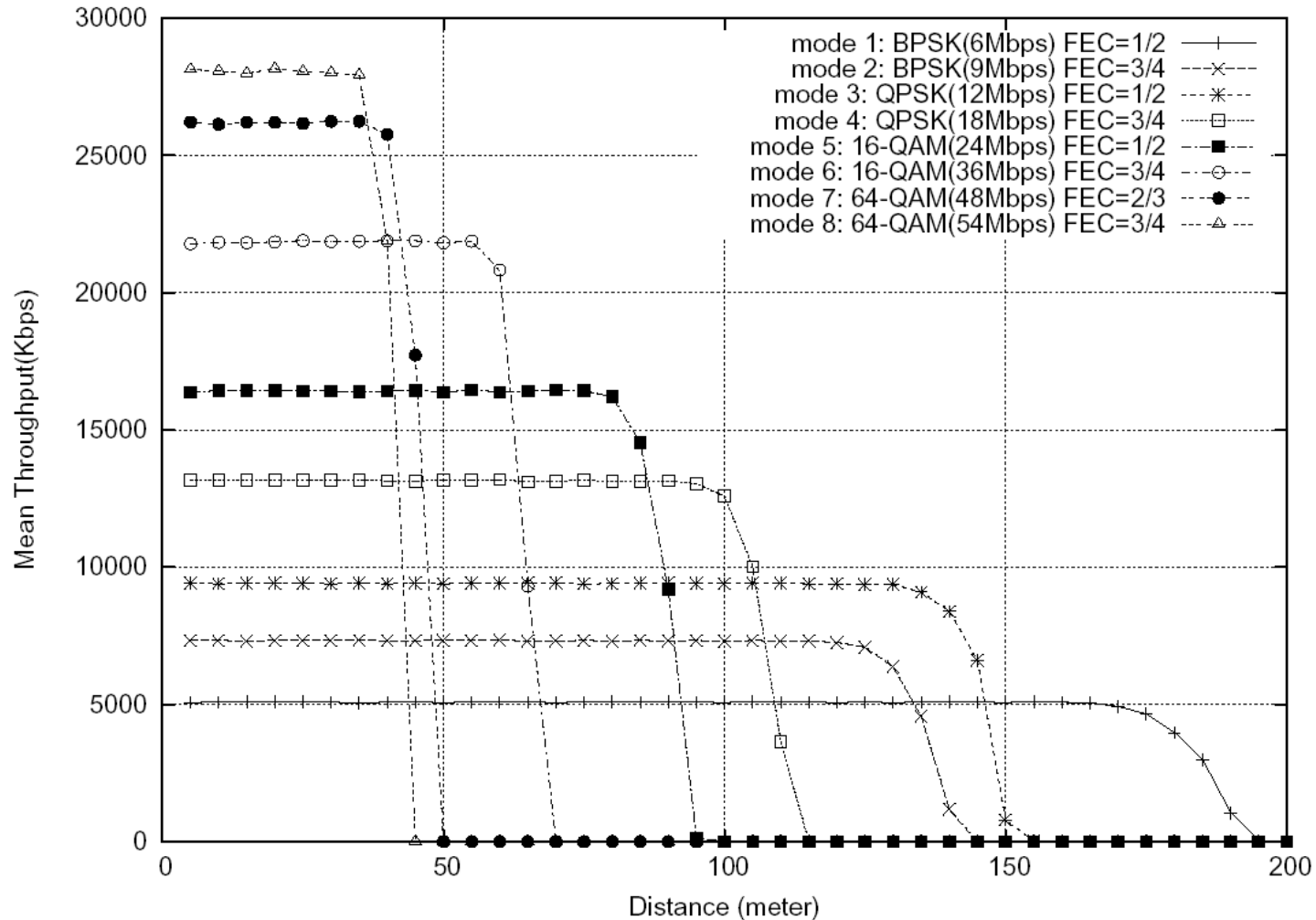

802.11 Frame Exchange Overhead

- ▶ Not all time is spent sending actual data

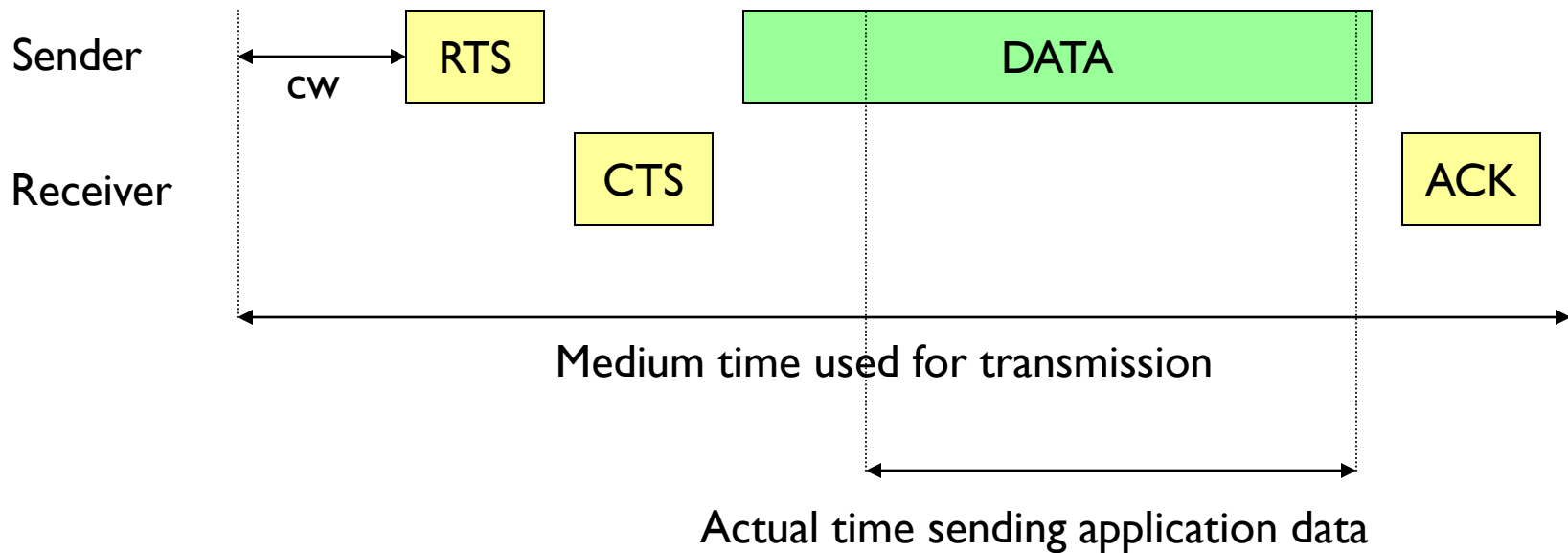

802.11b Frame Exchange Duration

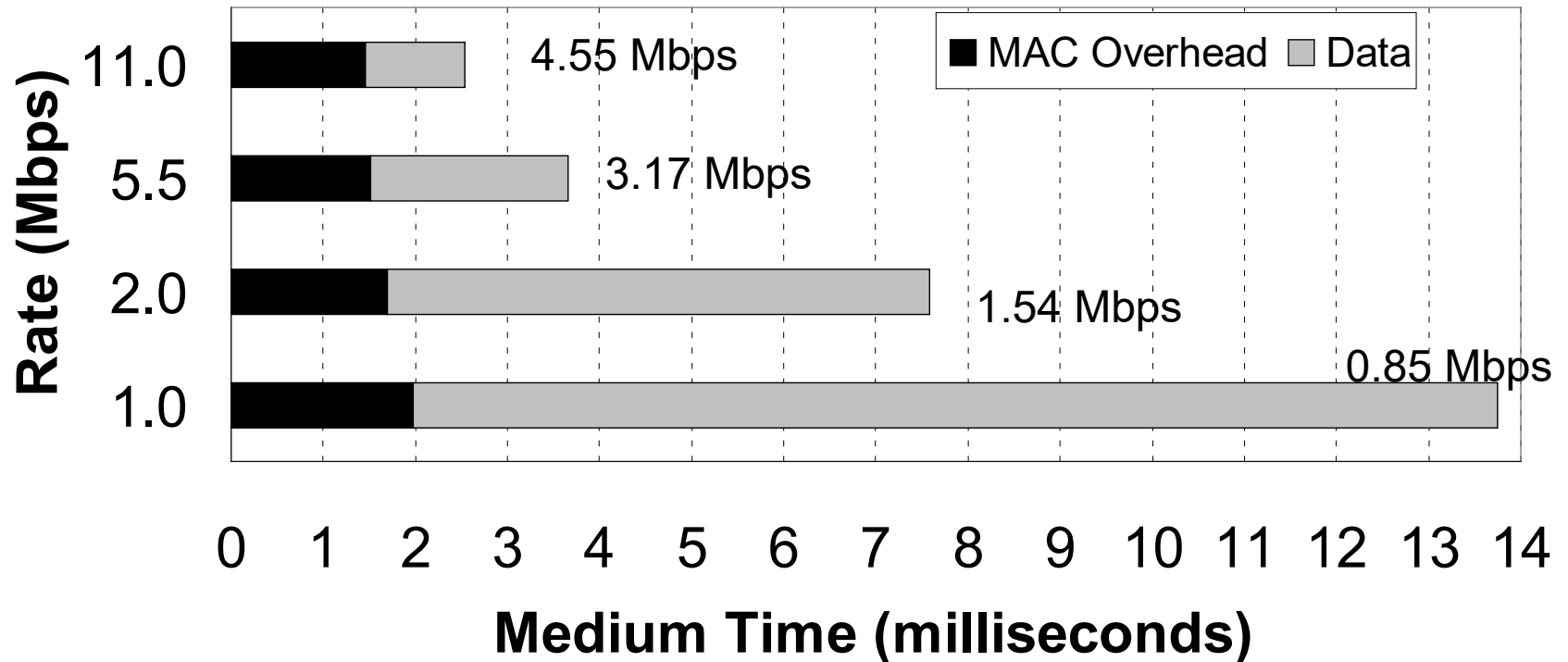

Medium Time consumed to transmit 1500 byte packet



Multi-rate Frame in 802.11b

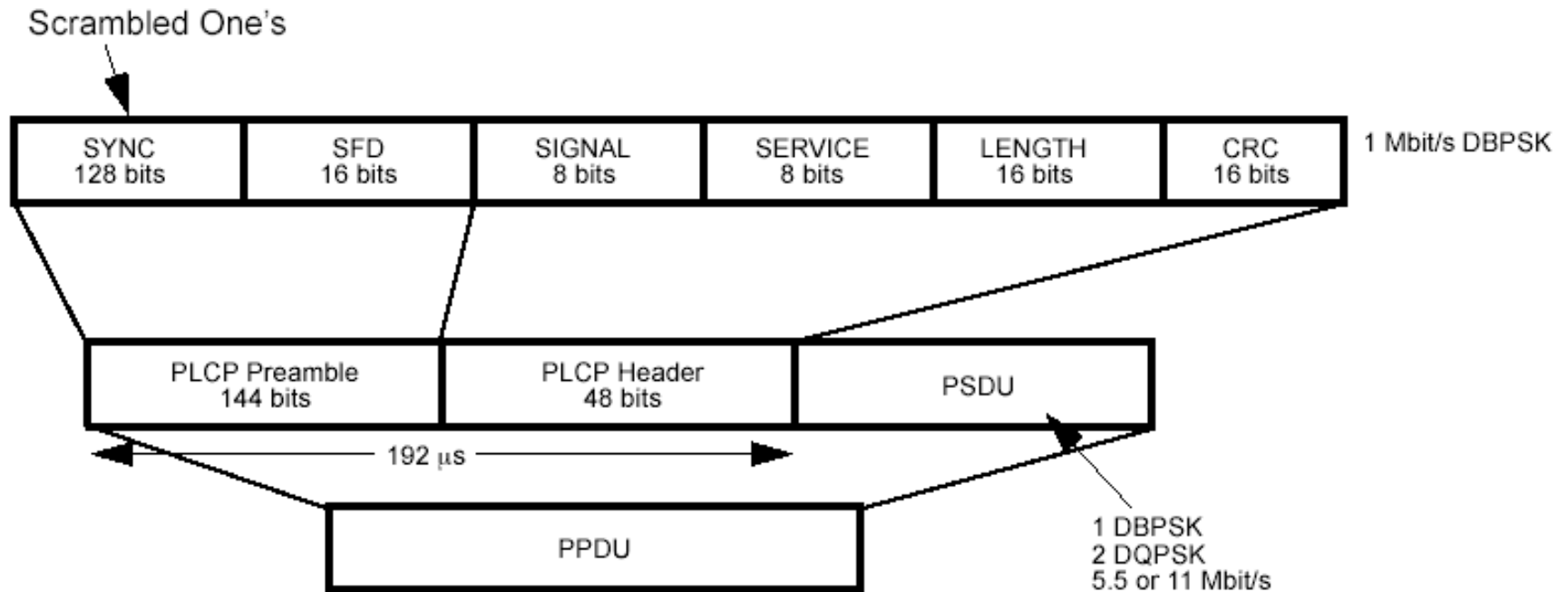
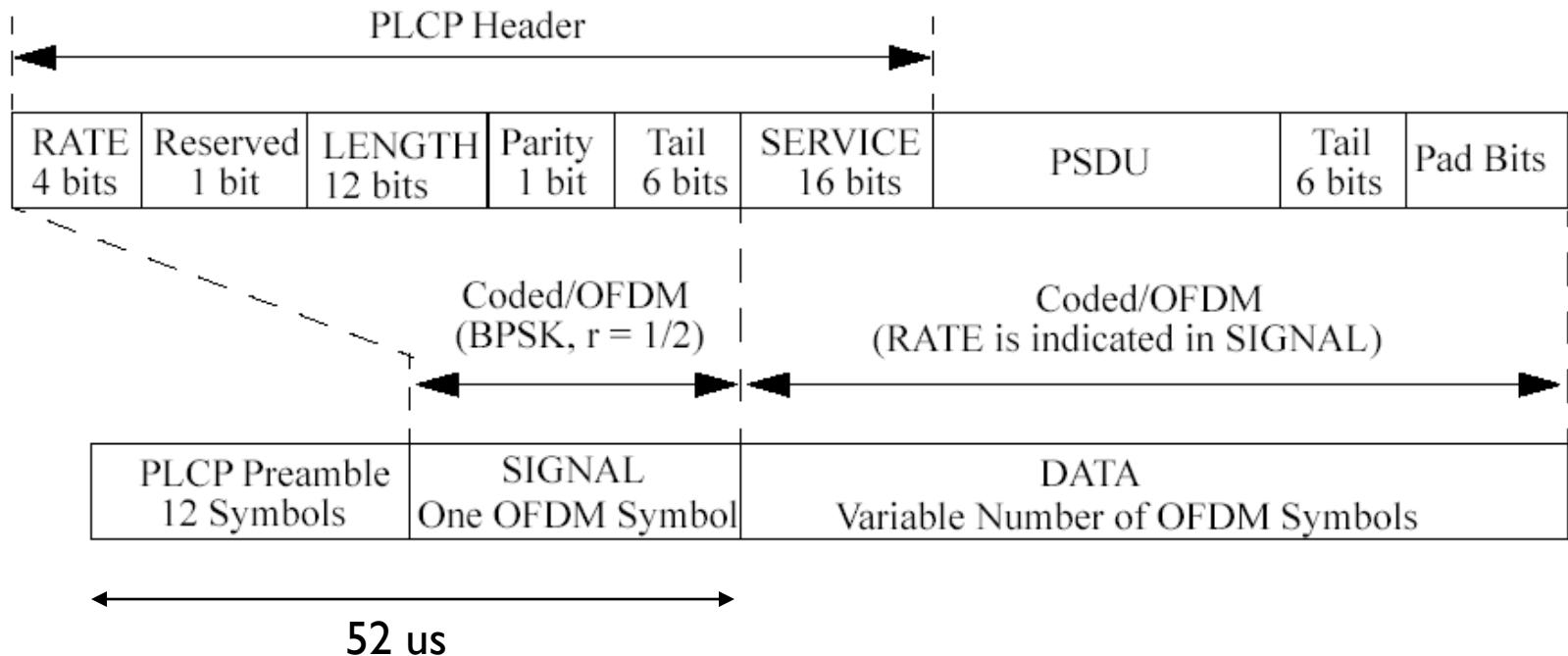
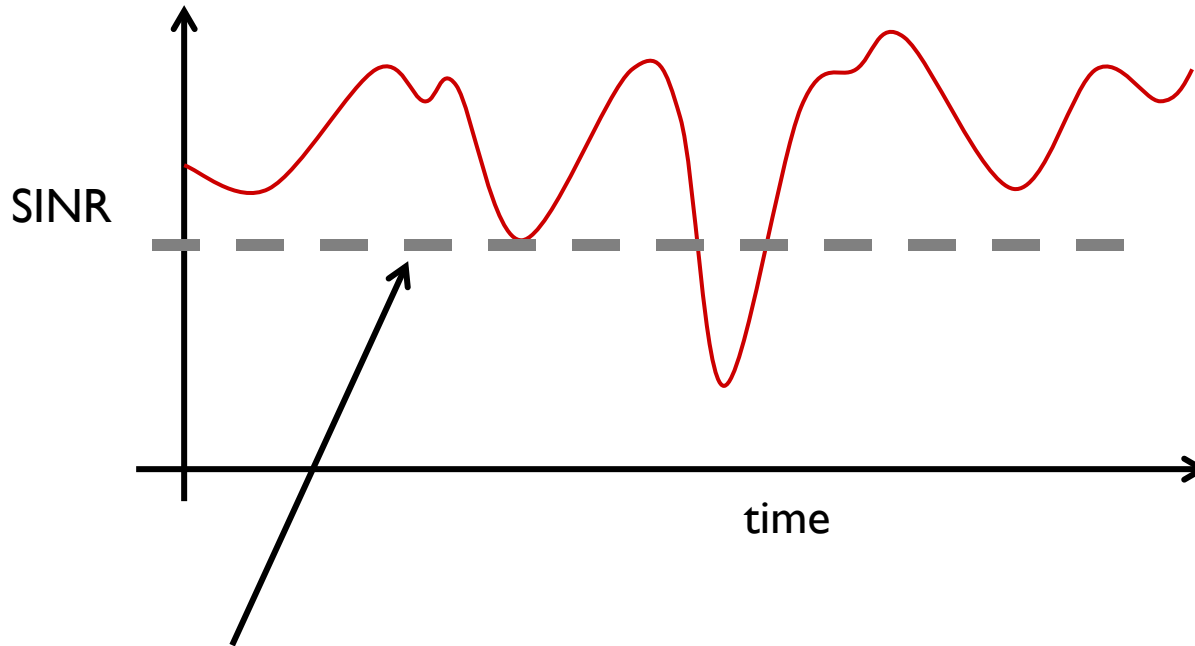

Figure 127—Long PLCP PDU format

Multi-rate Frame in 802.11a



How do we choose modulation rates?



- ▶ Estimate a value of SINR
- ▶ Choose a corresponding rate that would transmit packets correctly most of the times
- ▶ Failure in some cases of fading
 - ▶ Live with it

Adaptive Rate-Control

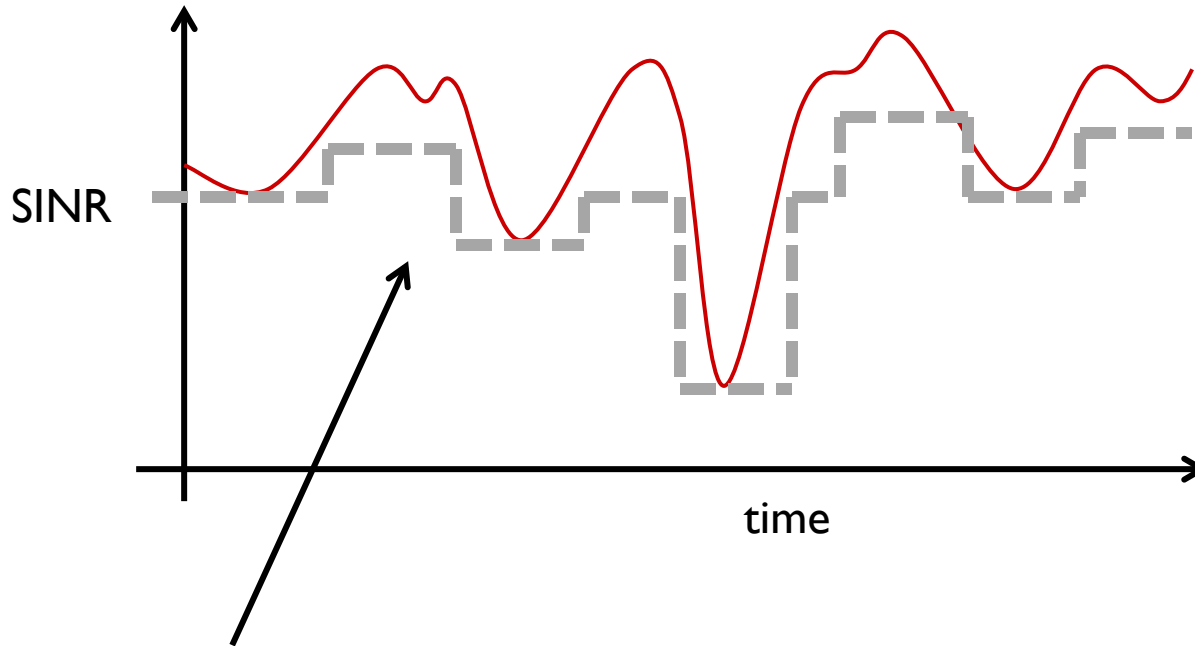

- ▶ **Observe the current value of SINR**
 - ▶ Use as indicator of near-future value
- ▶ **Choose corresponding rate of modulation**
- ▶ **Repeat**
 - ▶ Controls rate if channel conditions have changed

Seems simple, but ...

- ▶ Rate control has variety of implications
 - ▶ Any single MAC protocol solves part of the puzzle
- ▶ Important to understand e2e implications
 - ▶ Does routing protocols get affected?
 - ▶ Does TCP get affected?
 - ▶ ...
- ▶ Good to make a start at the MAC layer
 - ▶ ARF
 - ▶ RBAR
 - ▶ OAR
 - ▶ ...



Problem

- ▶ Modulation schemes have different error characteristics

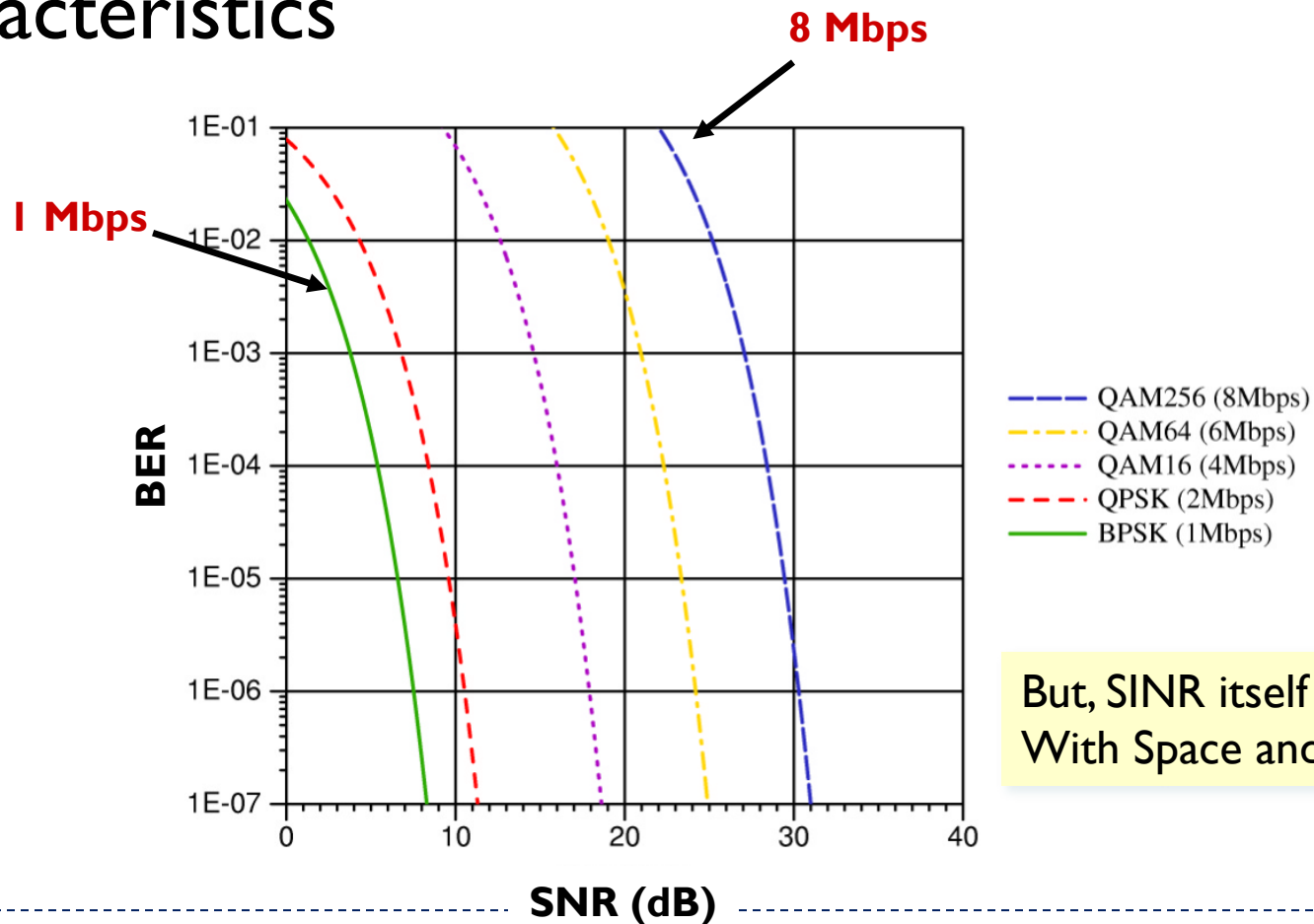

Impact

- ▶ Large-scale variation with distance (Path loss)

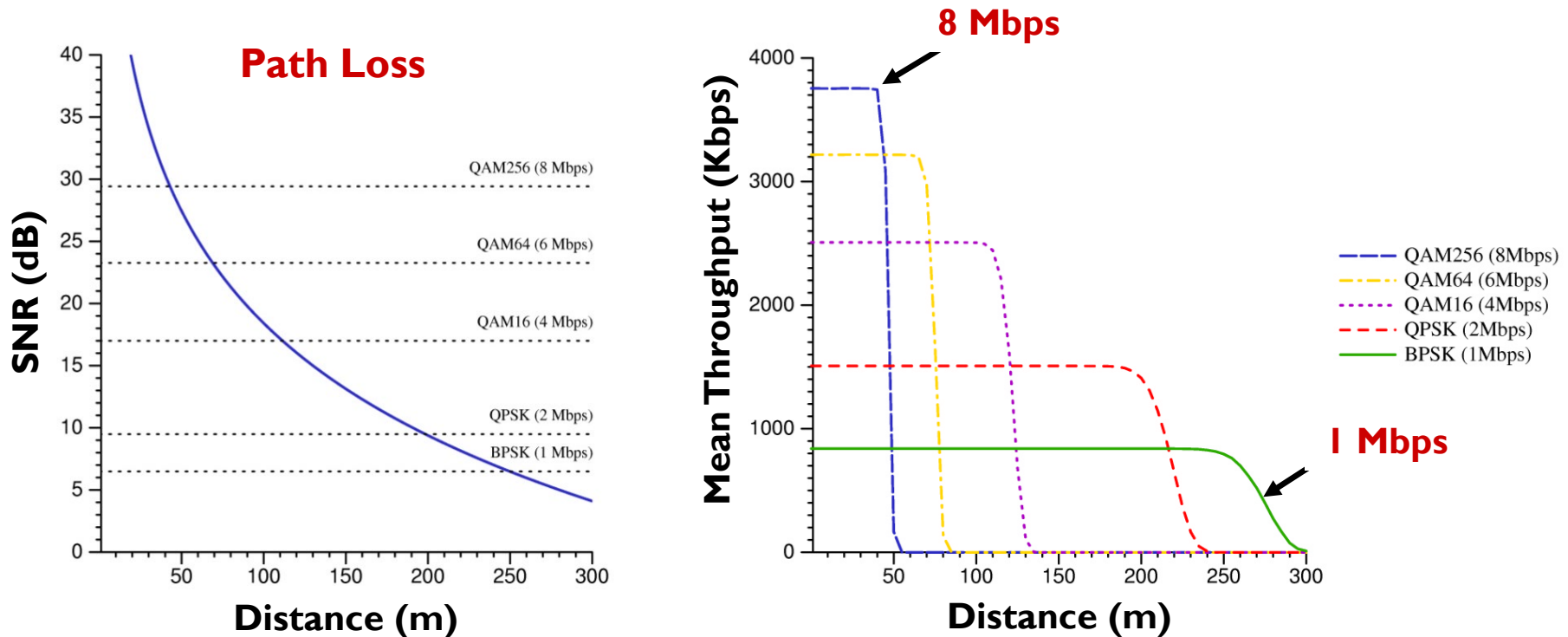

Impact

► Small-scale variation with time (Fading)

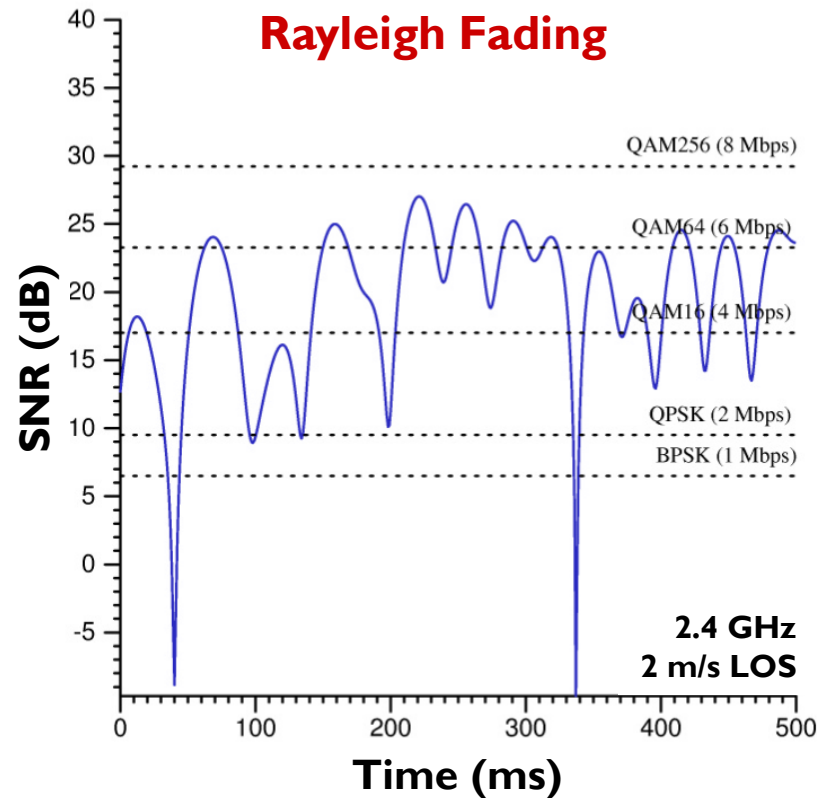

Which modulation scheme is best?

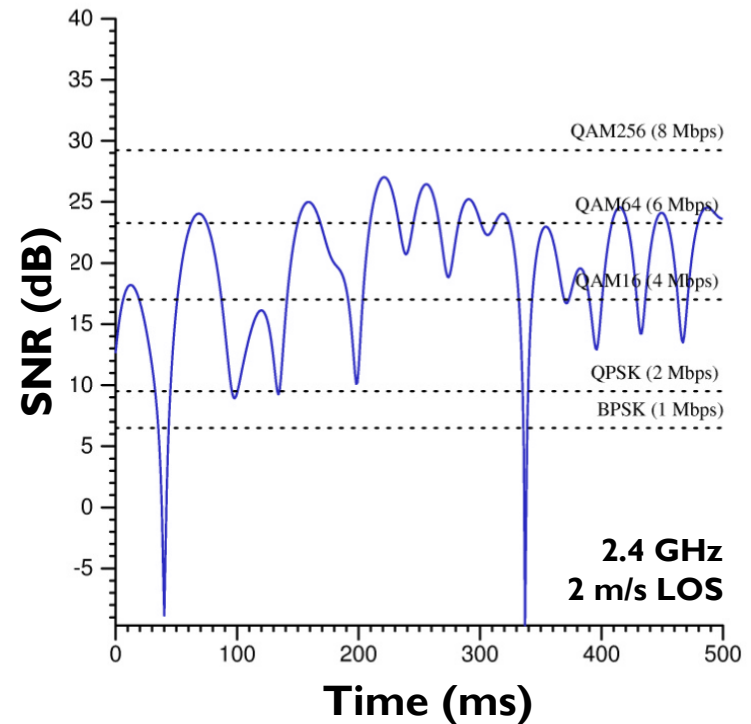
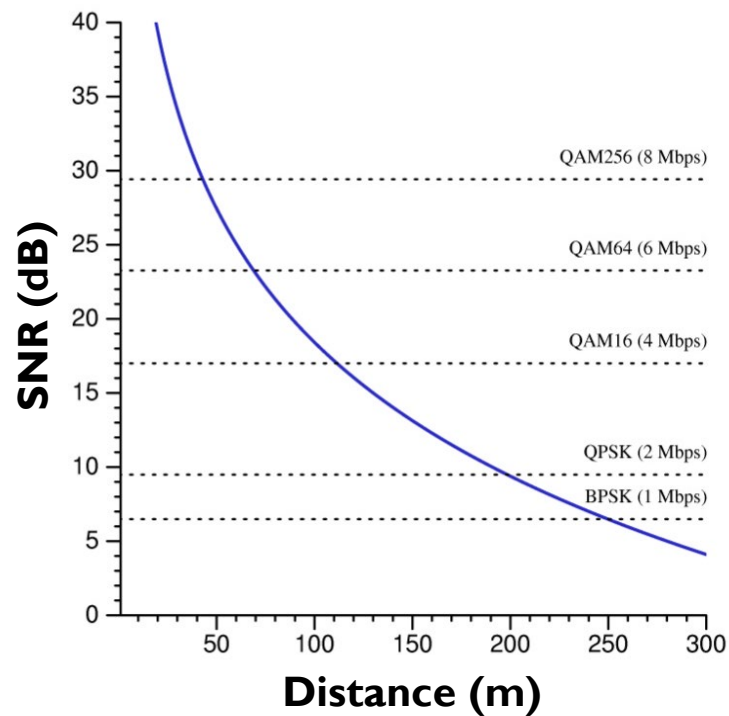

Answer → Rate Adaptation

- ▶ Dynamically choose the best modulation scheme for the channel conditions

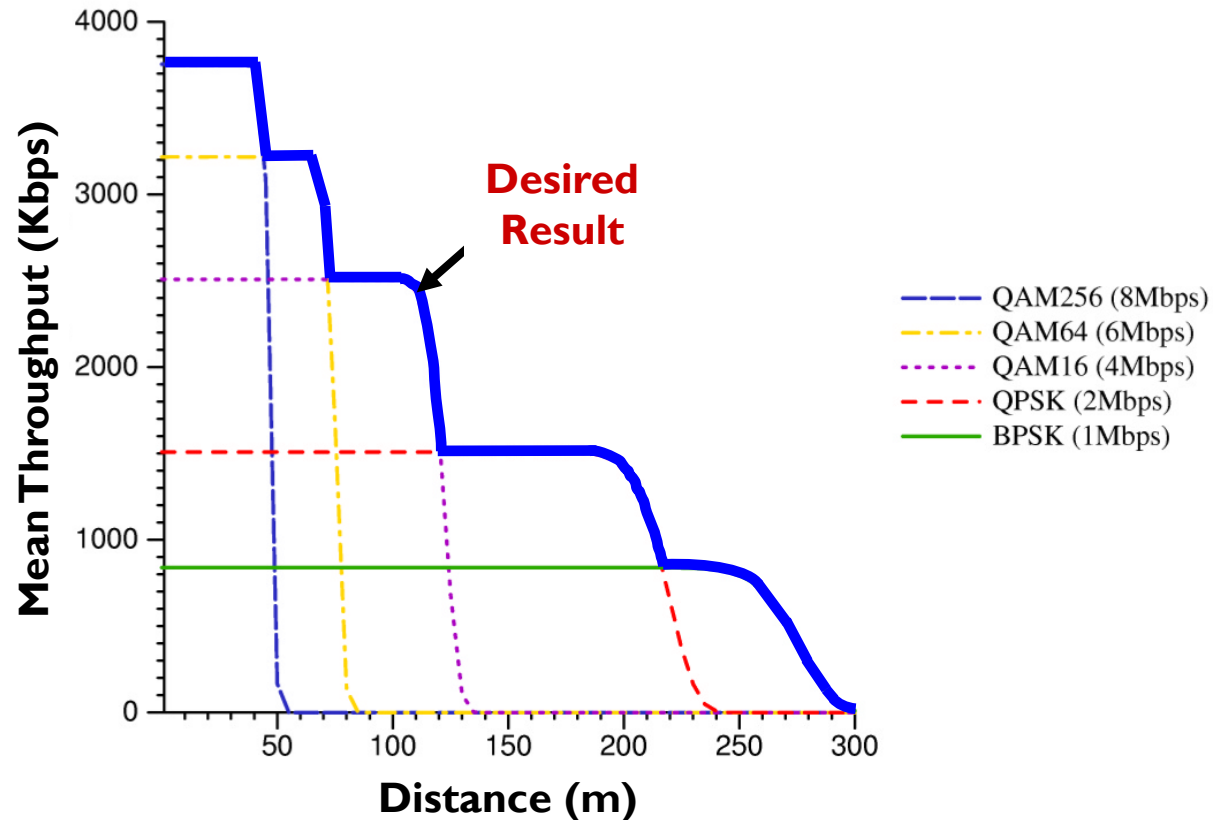

Design Issues

- ▶ How frequently should we adapt the rate?
 - ▶ Signal can vary rapidly depending on
 - ▶ carrier frequency
 - ▶ node speed
 - ▶ interference
 - ▶ etc.
- ▶ For conventional hardware at pedestrian speeds, rate adaptation is feasible on a per-packet basis



Adaptation → At Which Layer ?

- ▶ Cellular networks
 - ▶ Adaptation at the physical layer
- ▶ Impractical for 802.11 in WLANs

← Why?



Adaptation → At Which Layer ?

- ▶ Cellular networks
 - ▶ Adaptation at the physical layer
- ▶ Impractical for 802.11 in WLANs

← Why?

RTS/CTS requires that the *rate be known in advance*

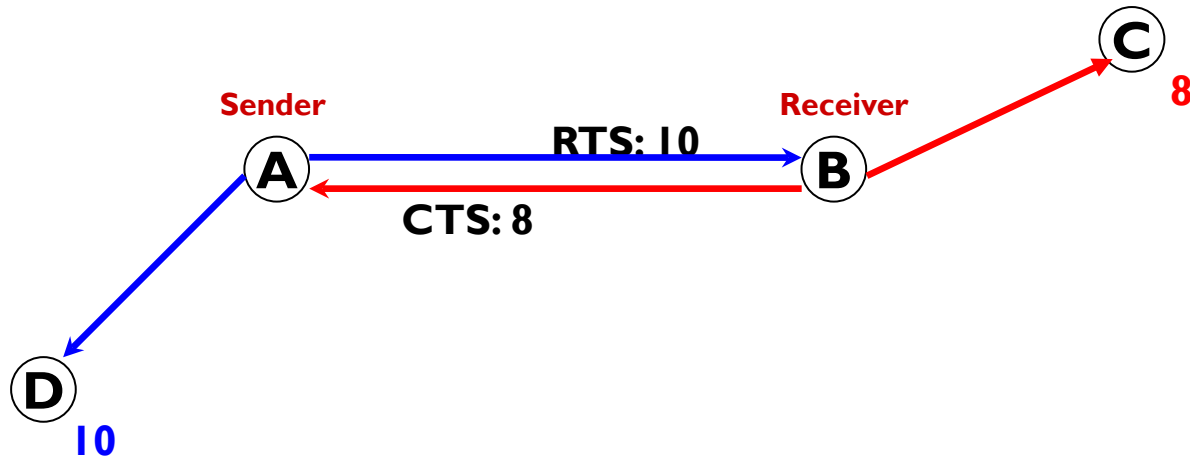

- ▶ For WLANs, rate adaptation is best handled at the MAC layer

Who should select the data rate?

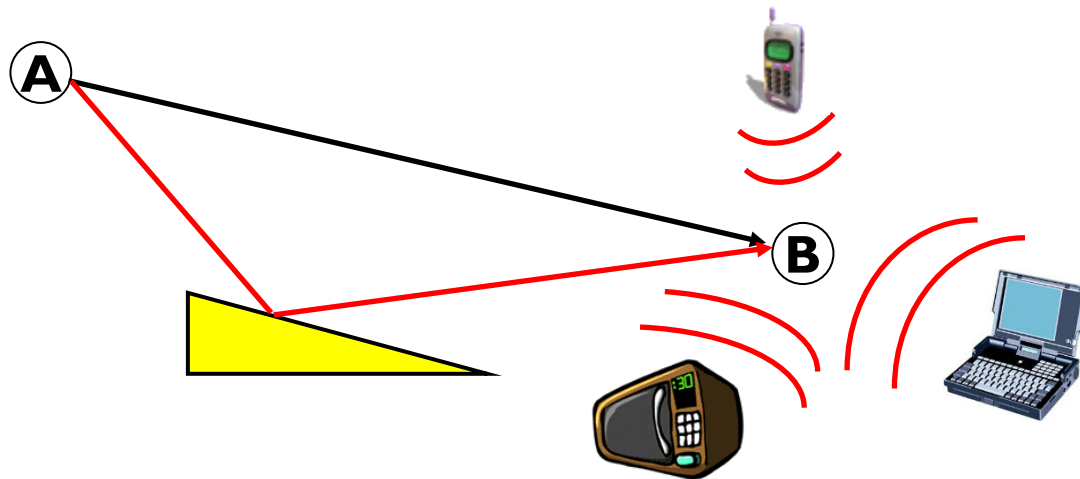

Who should select the data rate?

- ▶ Collision is at the receiver
- ▶ Channel conditions are only known at the receiver
 - ▶ SS, interference, noise, BER, etc.

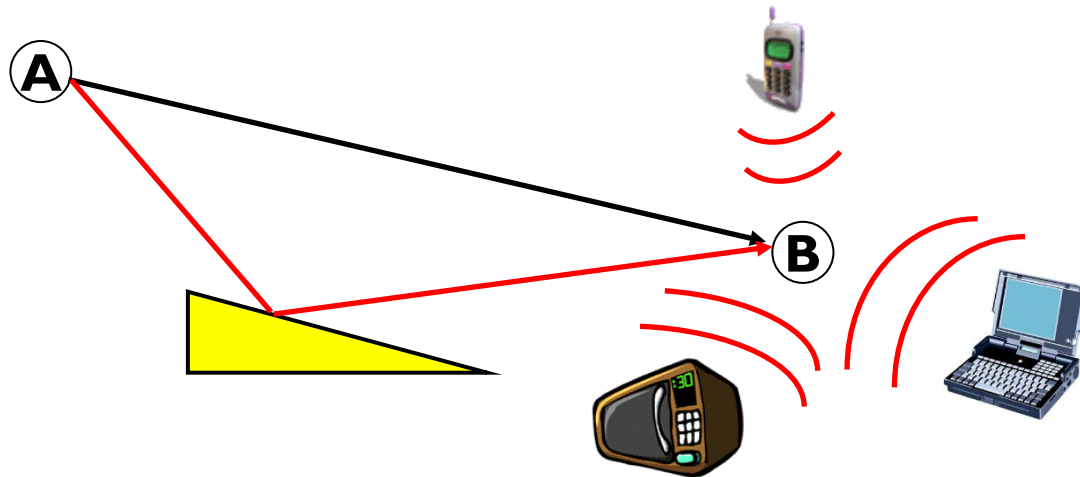

- ▶ The receiver is best positioned to select data rate

Lucent WaveLAN “Autorate Fallback” (ARF)

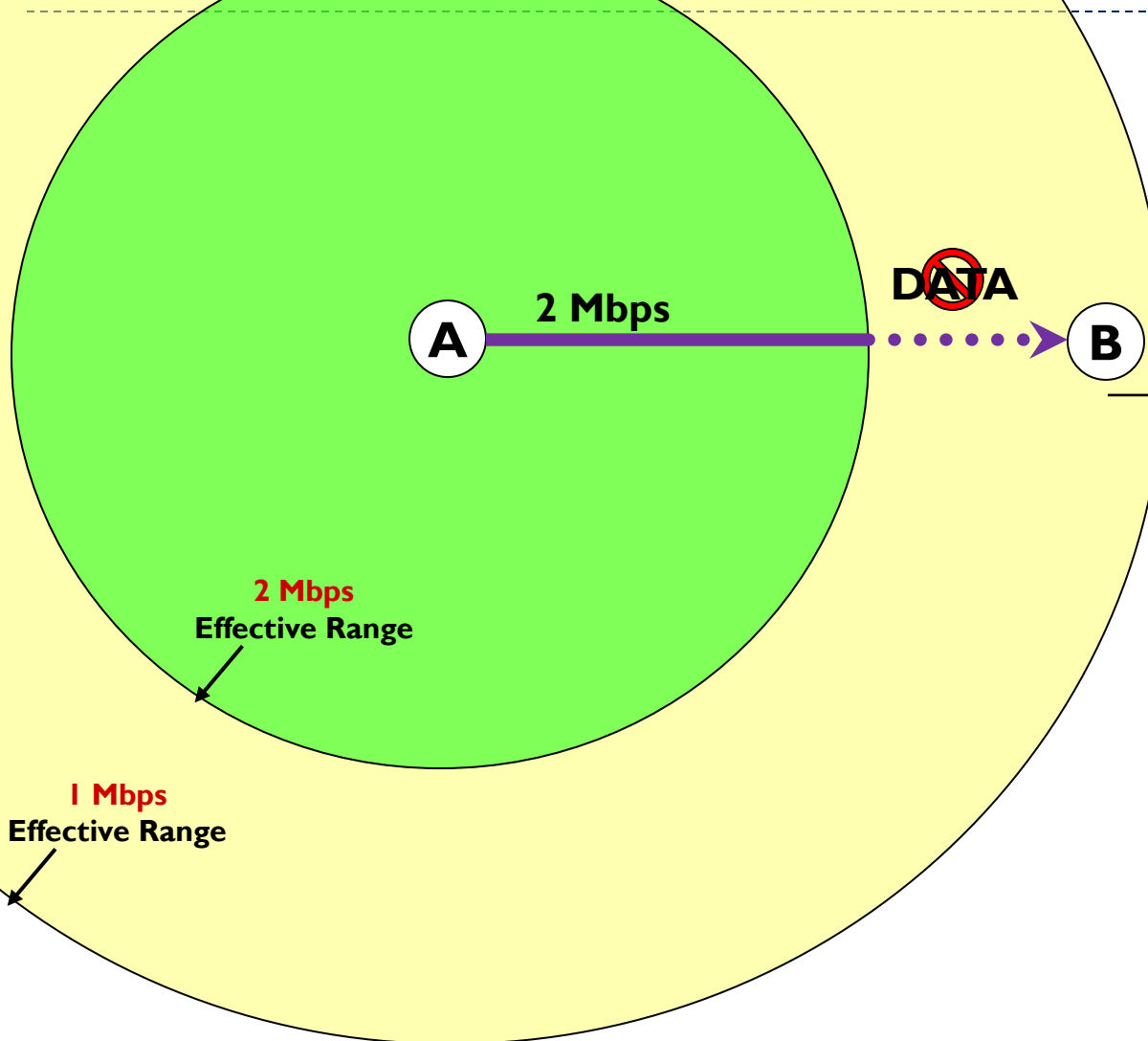

- ▶ Lost ACKs indicate link quality
- ▶ Sender decreases rate after
 - ▶ N consecutive ACKS are lost
- ▶ Sender increases rate after
 - ▶ Y consecutive ACKS are received or
 - ▶ T secs have elapsed since last attempt

Performance of ARF

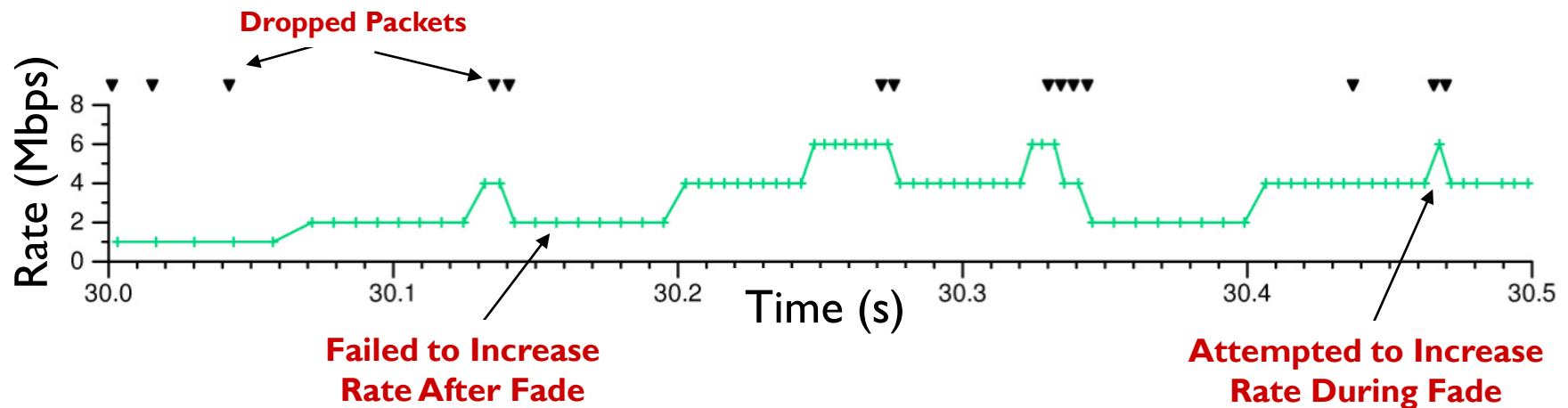
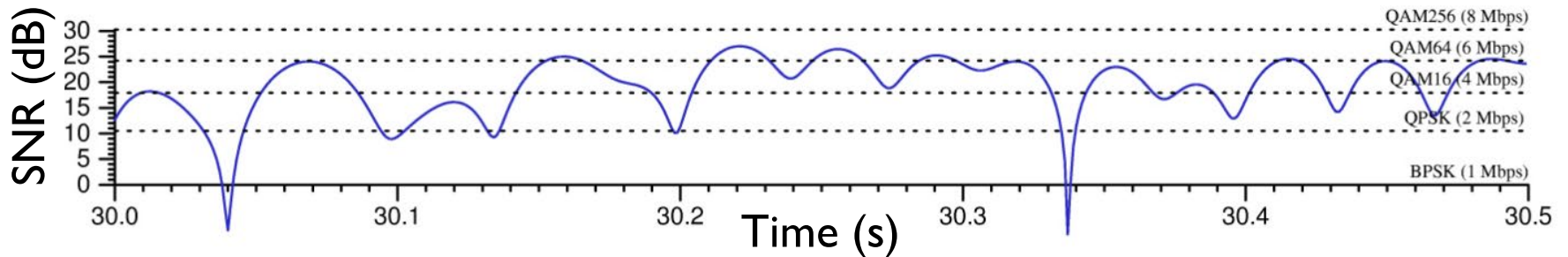

- ▶ Slow to adapt to channel conditions
- ▶ Choice of N, Y, T may not be best for all situations



Receiver-Based Autorate (RBAR)

- ▶ Move the rate adaptation mechanism to the receiver
 - ▶ Better channel quality information = better rate selection

- ▶ Utilize the RTS/CTS exchange to
 - ▶ Provide the receiver with a signal to sample (RTS)
 - ▶ Carry feedback (data rate) to the sender (CTS)



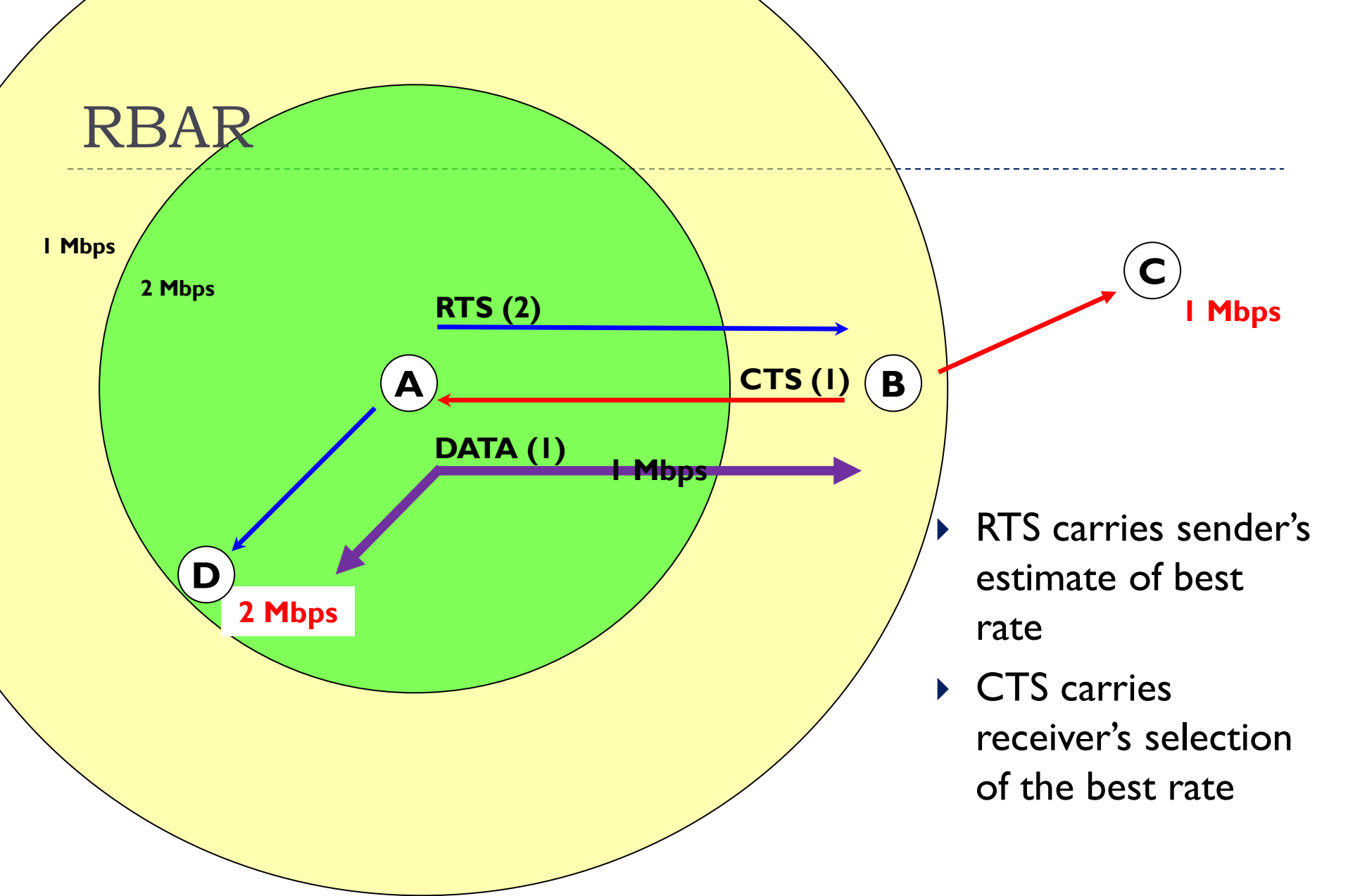

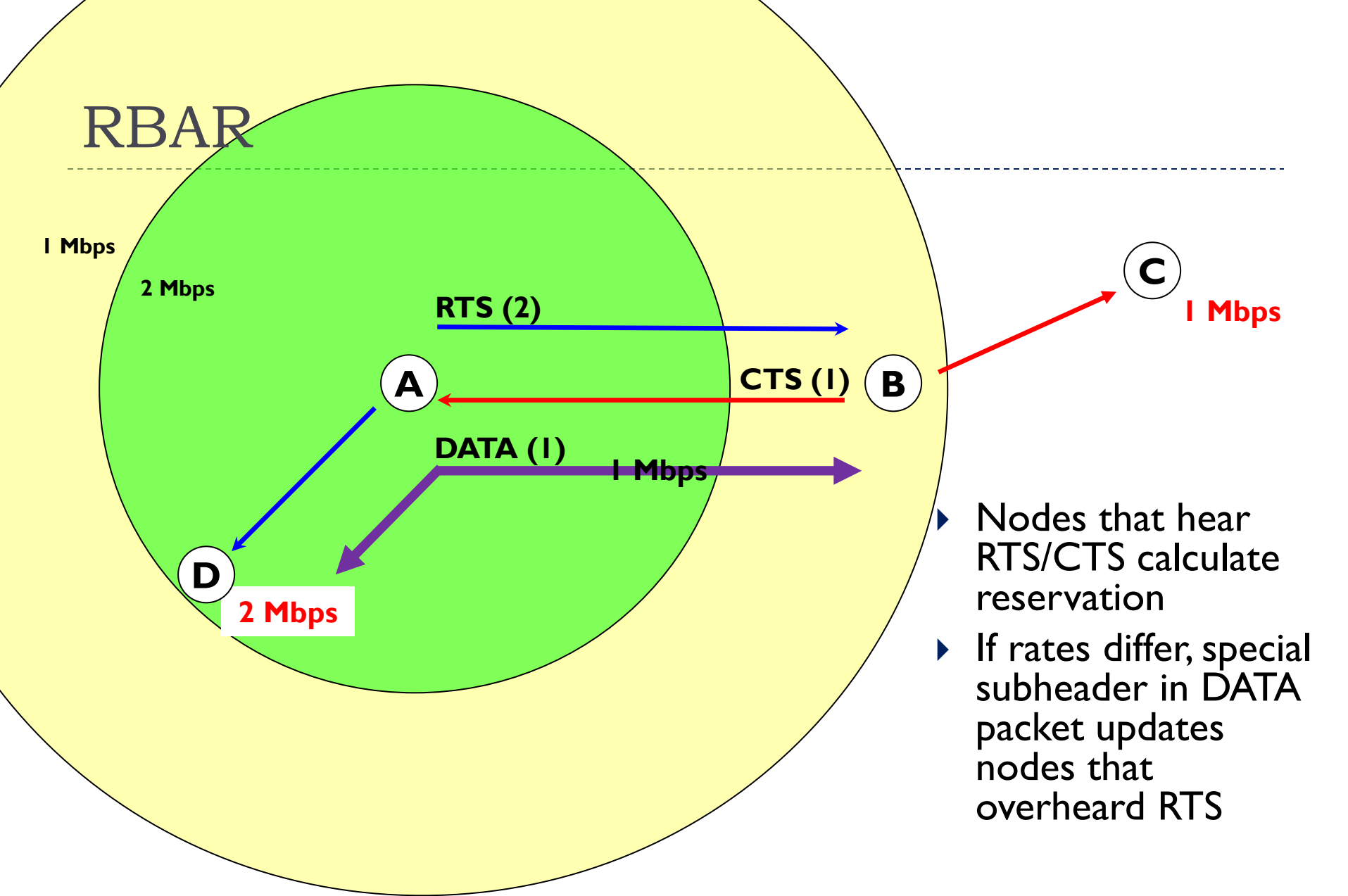

Performance of RBAR

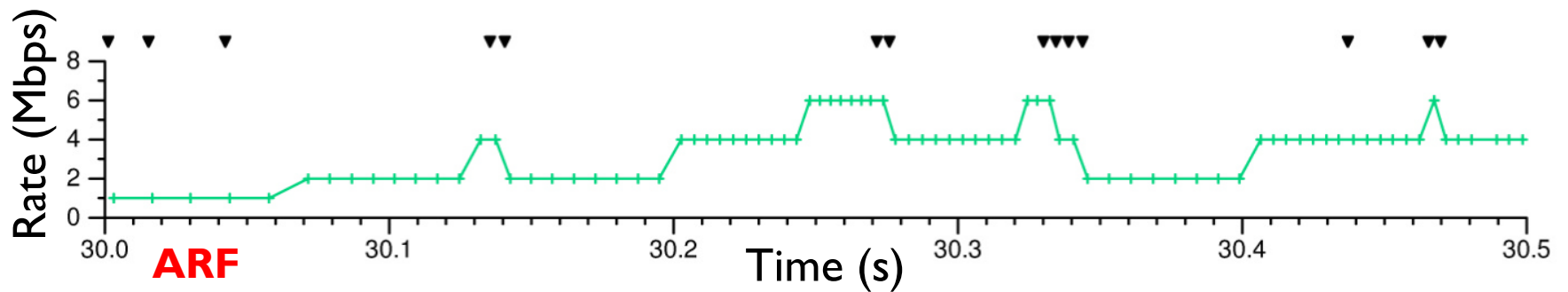
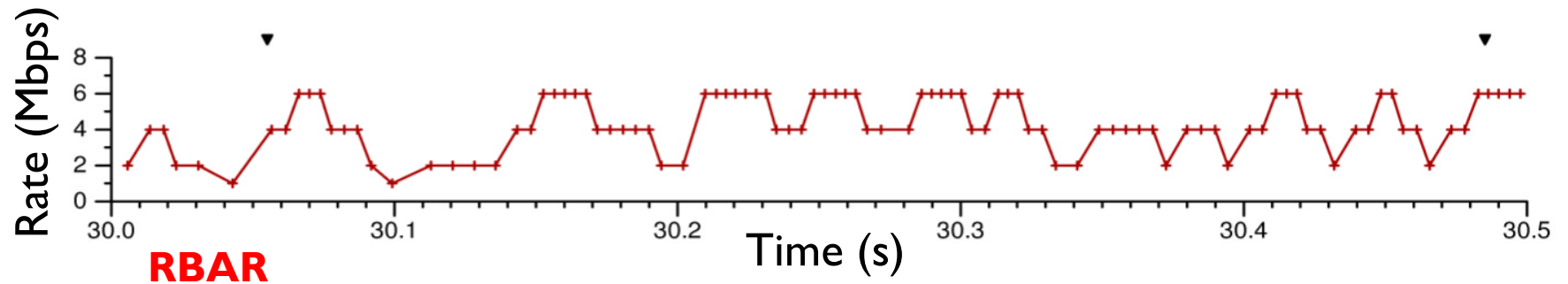
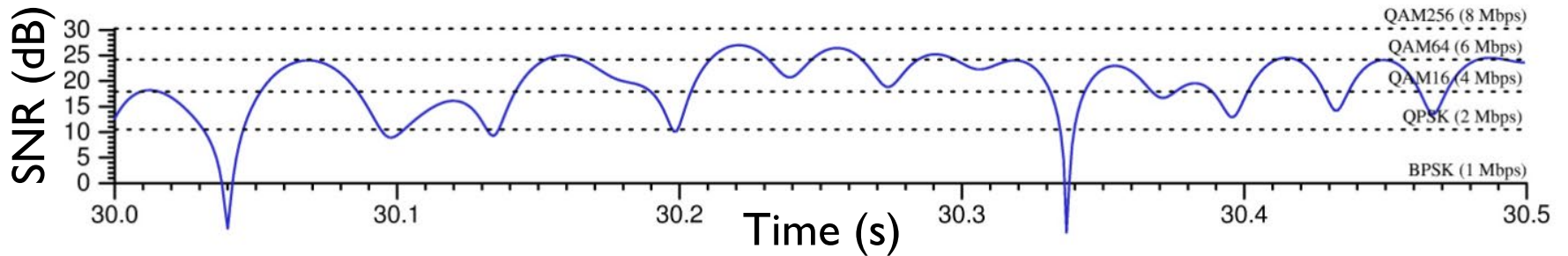

Implementation into 802.11

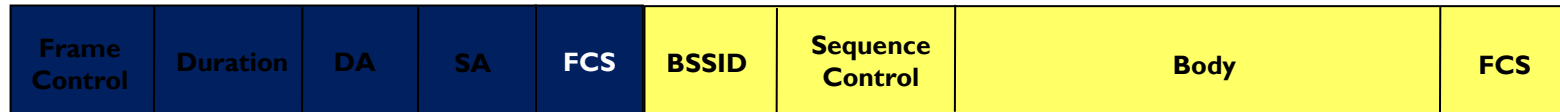

— **Reservation Subheader (RSH)** —

- ▶ Encode data rate and packet length in duration field of frames
 - ▶ Rate can be changed by receiver
 - ▶ Length can be used to select rate
 - ▶ Reservations are calculated using encoded rate and length
- ▶ New DATA frame type with Reservation Subheader (RSH)
 - ▶ Reservation fields protected by additional frame check sequence
 - ▶ RSH is sent at same rate as RTS/CTS
- ▶ New frame is only needed when receiver suggests rate change

RBAR Summary

- ▶ Modulation schemes have different error characteristics
- ▶ Significant performance improvement may be achieved by MAC-level adaptive modulation
- ▶ Receiver-based schemes may perform best
 - ▶ Proposed Receiver-Based Auto-Rate (RBAR) protocol
 - ▶ Implementation into 802.11
- ▶ Future thoughts ...
 - ▶ RBAR without use of RTS/CTS
 - ▶ RBAR based on the size of packets
 - ▶ Routing protocols for networks with variable rate links



Can we do better?

- ▶ Consider the situation below
 - ▶ ARF?
 - ▶ RBAR?

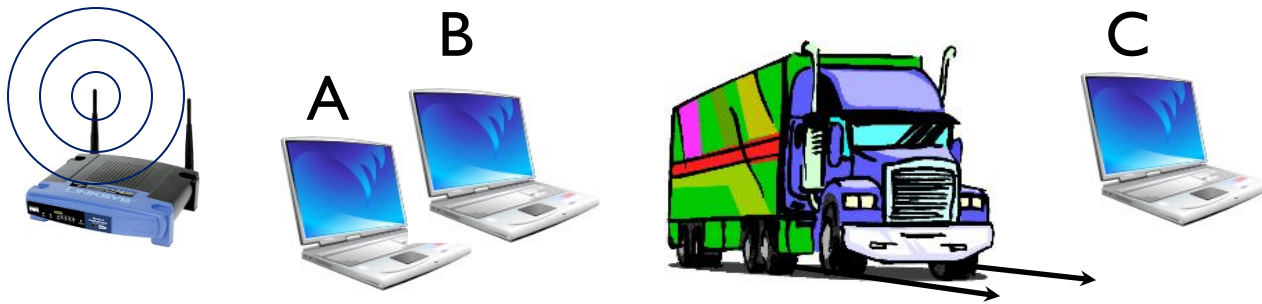

Motivation

- ▶ What if A and B are both at 56Mbps, and C is often at 2Mbps?
- ▶ Slowest node gets the most absolute time on channel?

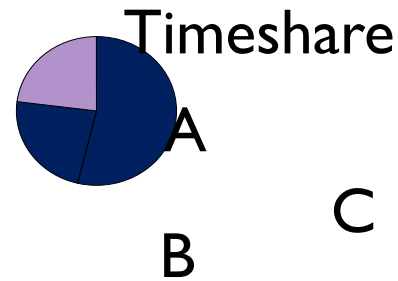

Throughput Fairness vs Temporal Fairness

MAC Layer Fairness Models

▶ Per Packet Fairness

- ▶ If two adjacent senders continuously are attempting to send packets, they should each send the same number of packets

▶ Temporal Fairness

- ▶ If two adjacent senders are continuously attempting to send packets, they should each be able to send for the same amount of medium time.

▶ In single rate networks these are the **SAME!**



Temporal Fairness Example

	802.11 Packet Fairness	OAR Temporal Fairness
11 Mbps Link	0.896	3.533
1 Mbps Link	0.713	0.450
Total Throughput	1.609	3.983

Per Packet Fairness

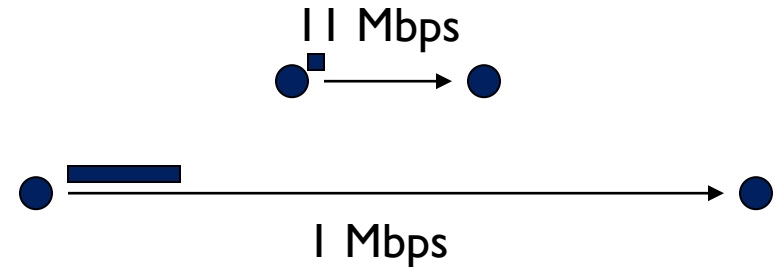

Temporal Fairness

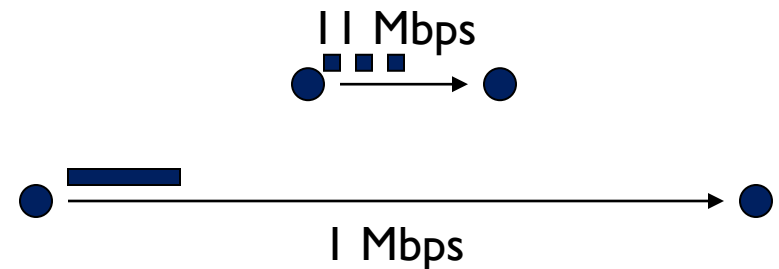

Opportunistic Scheduling

▶ Goal

- ▶ Exploit short-time-scale channel quality variations to increase throughput

▶ Issue

- ▶ Maintaining temporal fairness (time share) of each node

▶ Challenge

- ▶ Channel info available only upon transmission

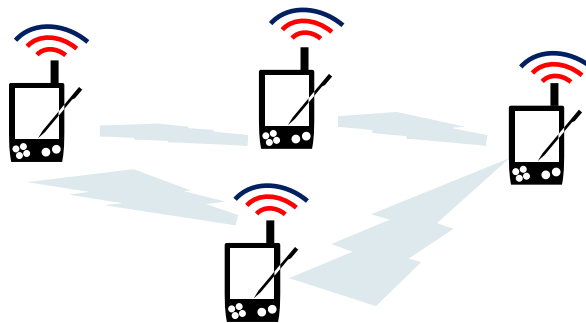

Opportunistic Auto-Rate (OAR)

- ▶ In many networks, there is intrinsic diversity
 - ▶ Exploiting this diversity can offer benefits
 - ▶ Transmit more when channel quality is high
 - ▶ else, free the channel quickly
- ▶ RBAR does not exploit this diversity
 - ▶ It optimizes per-link throughput



OAR Idea

▶ Basic Idea

- ▶ Bad channel: transmit minimum number of packets
- ▶ Good channel: transmit as much as possible

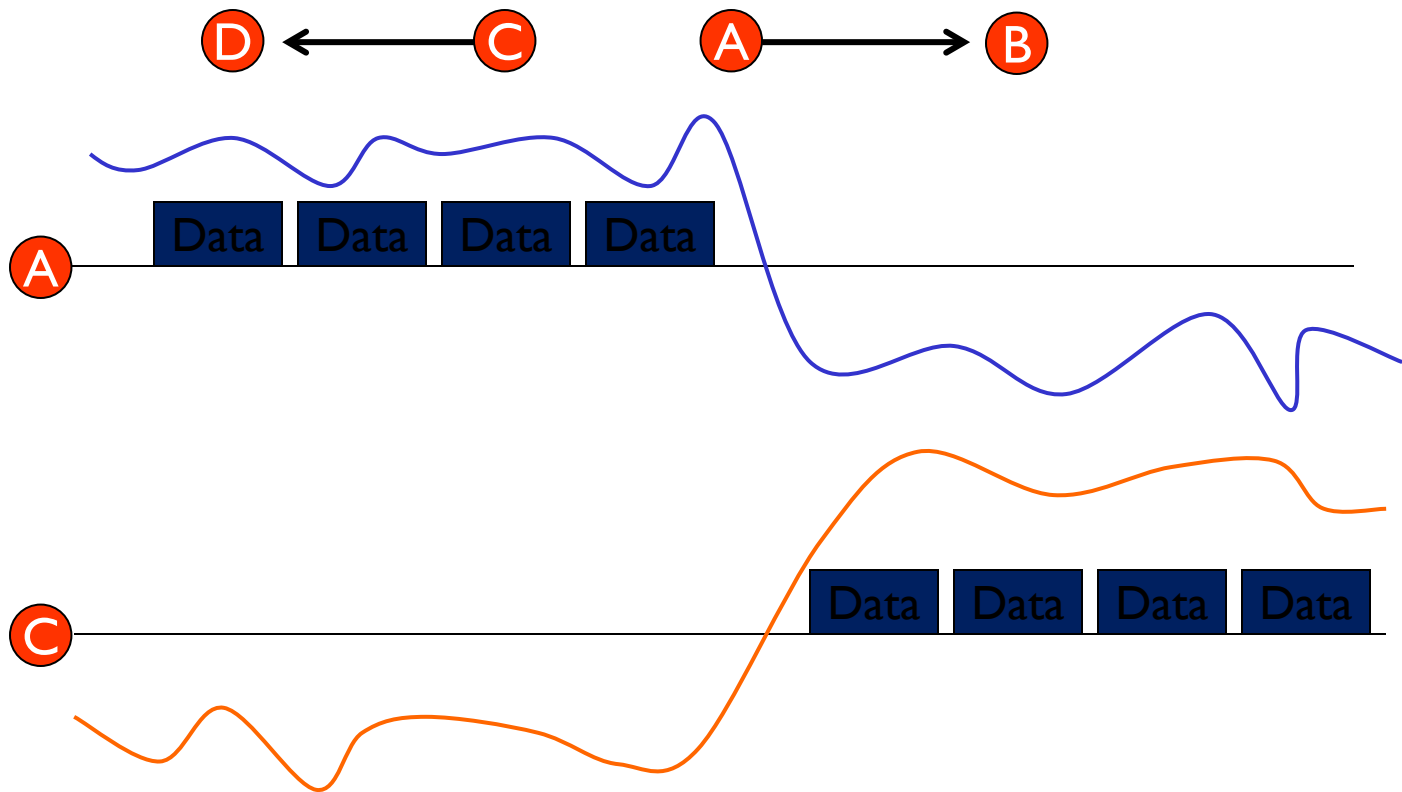

Why is OAR better?

- ▶ 802.11 alternates between transmitters A and C
 - ▶ Why is that bad

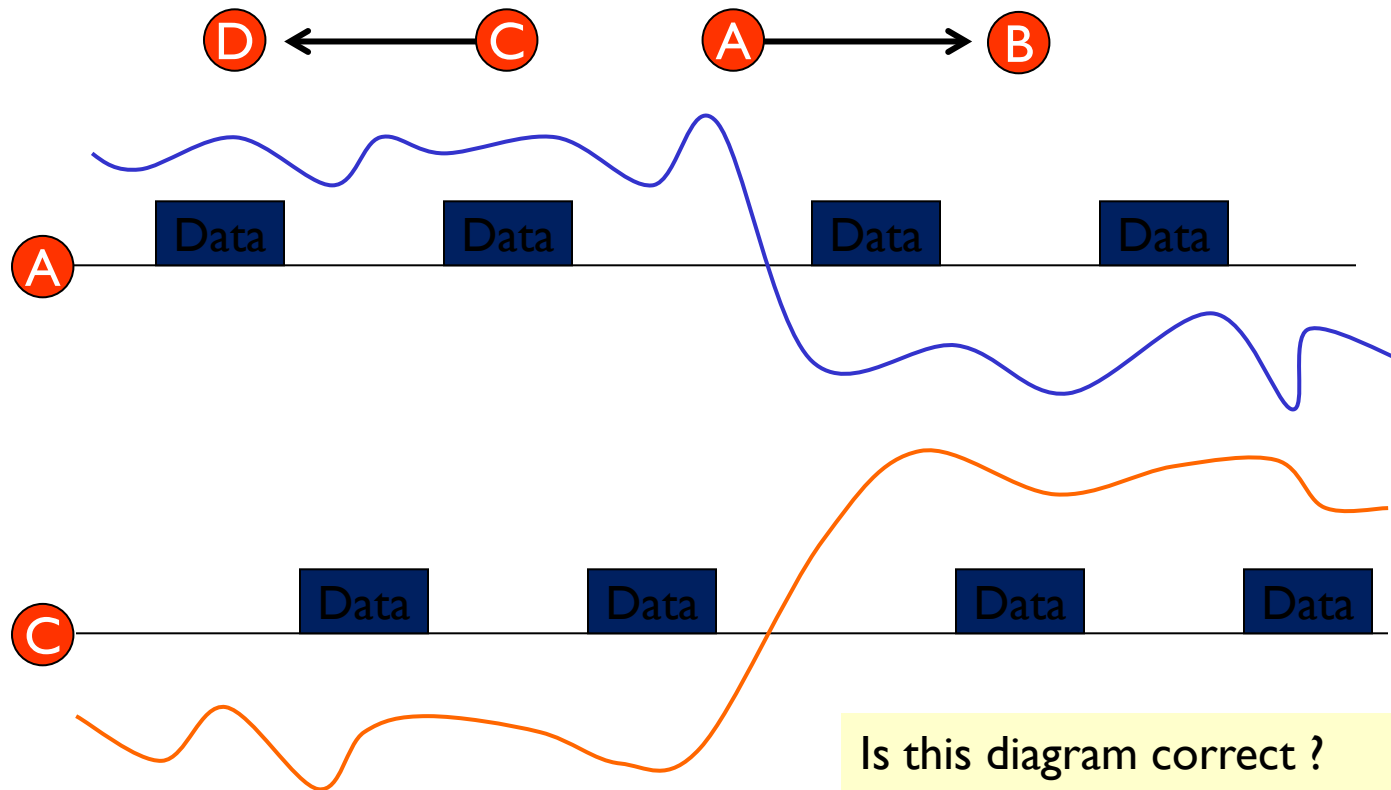

Why is OAR better ?

- ▶ Bad channel reduces SINR \rightarrow increases transmit time
- ▶ Fewer packets can be delivered

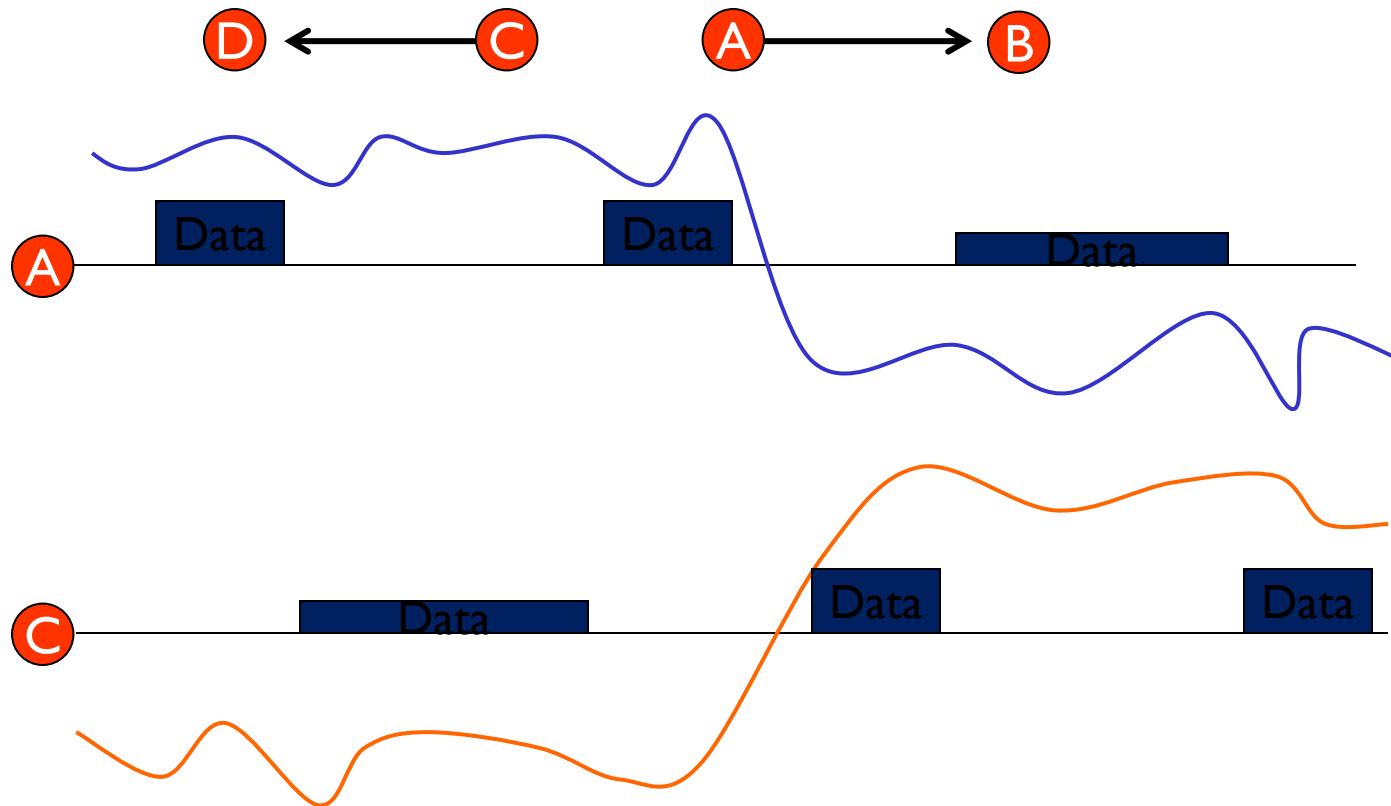

OAR Protocol Steps

- ▶ **Transmitter estimates current channel**
 - ▶ Can use estimation algorithms
 - ▶ Can use RBAR, etc.
- ▶ **If channel better than base rate (2 Mbps)**
 - ▶ Transmit proportionally more packets
 - ▶ e.g., if channel can support 11 Mbps, transmit $(11/2 \sim 5)$ pkts
- ▶ **OAR upholds temporal fairness**
 - ▶ Each node gets same duration to transmit
 - ▶ Sacrifices throughput fairness → the network gains!!



OAR Protocol

Protocol	Channel Condition					
	BAD		MEDIUM		GOOD	
	Pkts	Rate	Pkts	Rate	Pkts	Rate
802.11	1	2	1	2	1	2
802.11b	1	2	1	5.5	1	11
OAR	1	2	3	5.5	5	11

- ▶ Rates in IEEE 802.11b: 2, 5.5, and 11 Mbps



Summary

- ▶ **Rate control can be useful**
 - ▶ When adapted to channel fluctuations (RBAR)
 - ▶ When opportunistically selecting transmitters (OAR)
- ▶ **Benefits maximal when**
 - ▶ Channel conditions vary widely in time and space
- ▶ **Correlation in fluctuation can offset benefits**
 - ▶ OAR may show negligible gains



What lies ahead ?

- ▶ **Dual of rate-control is power control**
 - ▶ One might be better than the other
 - ▶ Decision often depends on the scenario → open problem

