

# Apache Spark

Lecture by: Faria Kalim (lead TA)

CS425 Fall 2019

UIUC

# Why Spark?

- Another system for big data analytics
- Isn't MapReduce good enough?
  - Simplifies batch processing on large commodity clusters

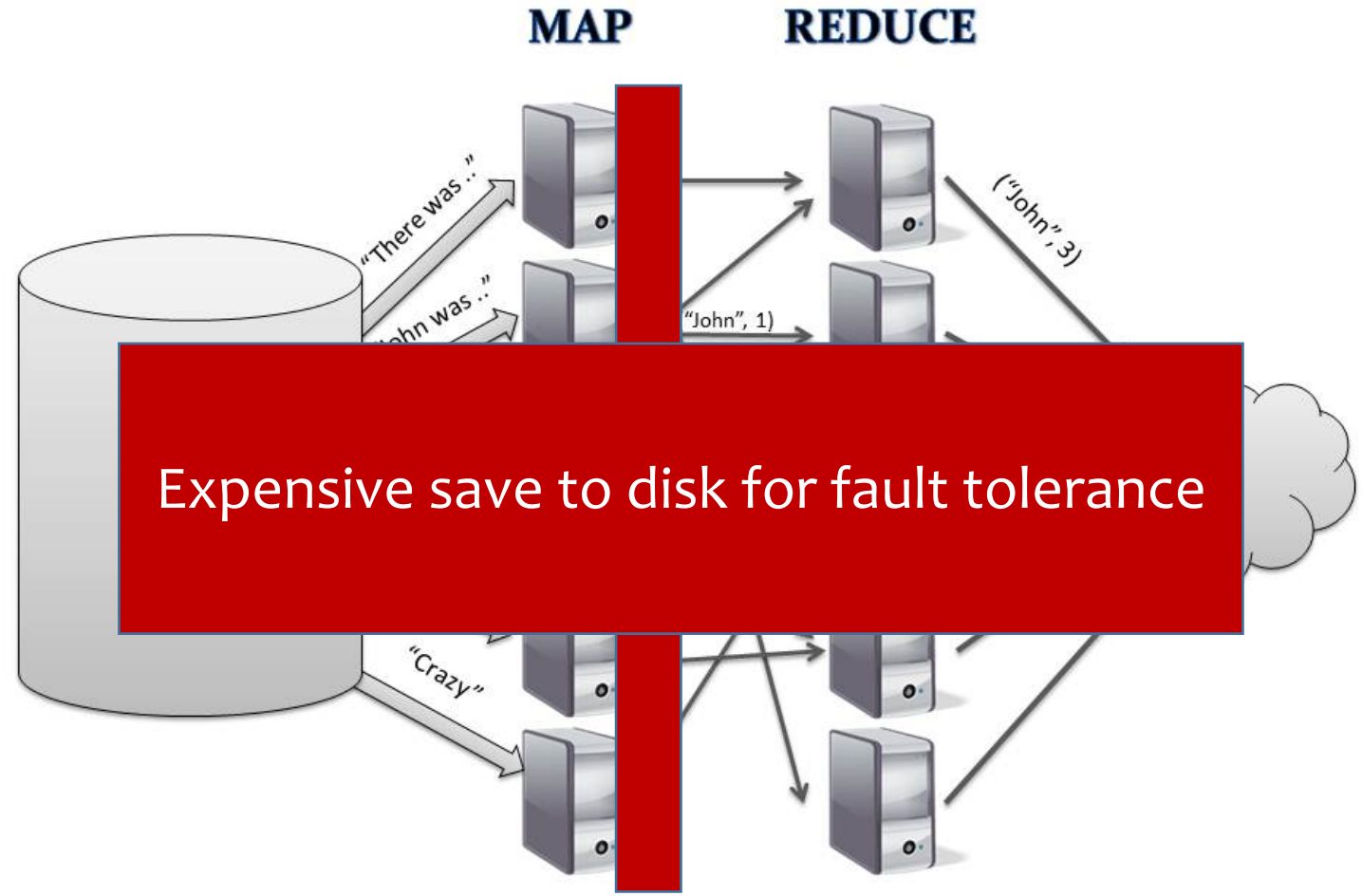

Expensive save to disk for fault tolerance

# Why Spark?

- MapReduce can be expensive for some applications e.g.,
  - Iterative
  - Interactive
- Lacks efficient data sharing
- Specialized frameworks did evolve for different programming models
  - Bulk Synchronous Processing (Pregel)
  - Iterative MapReduce (Haloop) ....

# Solution: Resilient Distributed Datasets (RDDs)

- RDDs
  - Immutable, partitioned collection of records
  - Built through coarse grained transformations (map, join ...)
  - Can be cached for efficient reuse

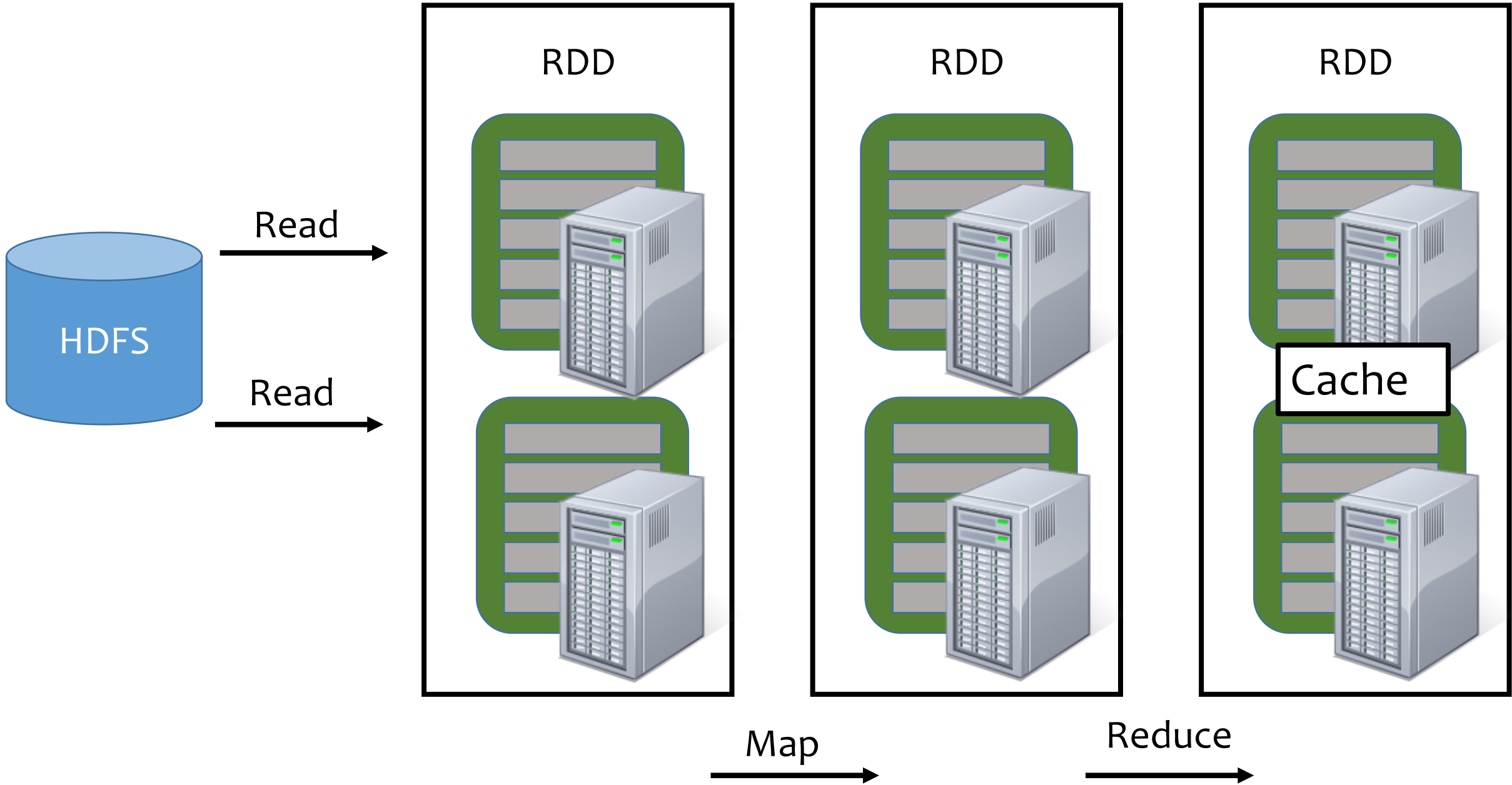

# Solution: Resilient Distributed Datasets (RDDs)

- RDDs
  - Immutable, partitioned collection of records
  - Built through coarse grained, ordered transformations (map, join ...)
- Fault Recovery?
  - Lineage!
    - Log the coarse grained operation applied to a partitioned dataset
    - Simply recompute the lost partition if failure occurs!
    - No cost if no failure

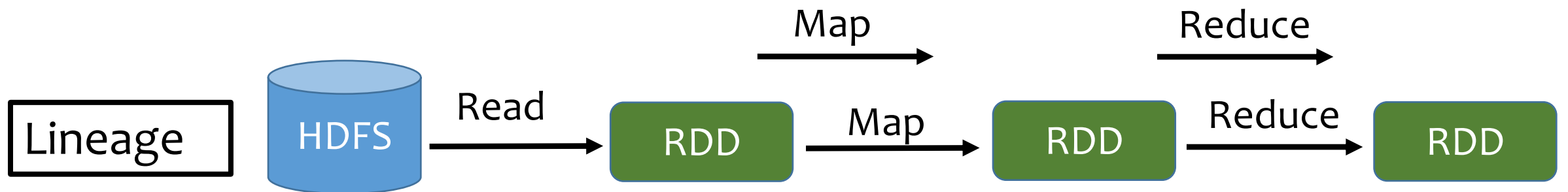
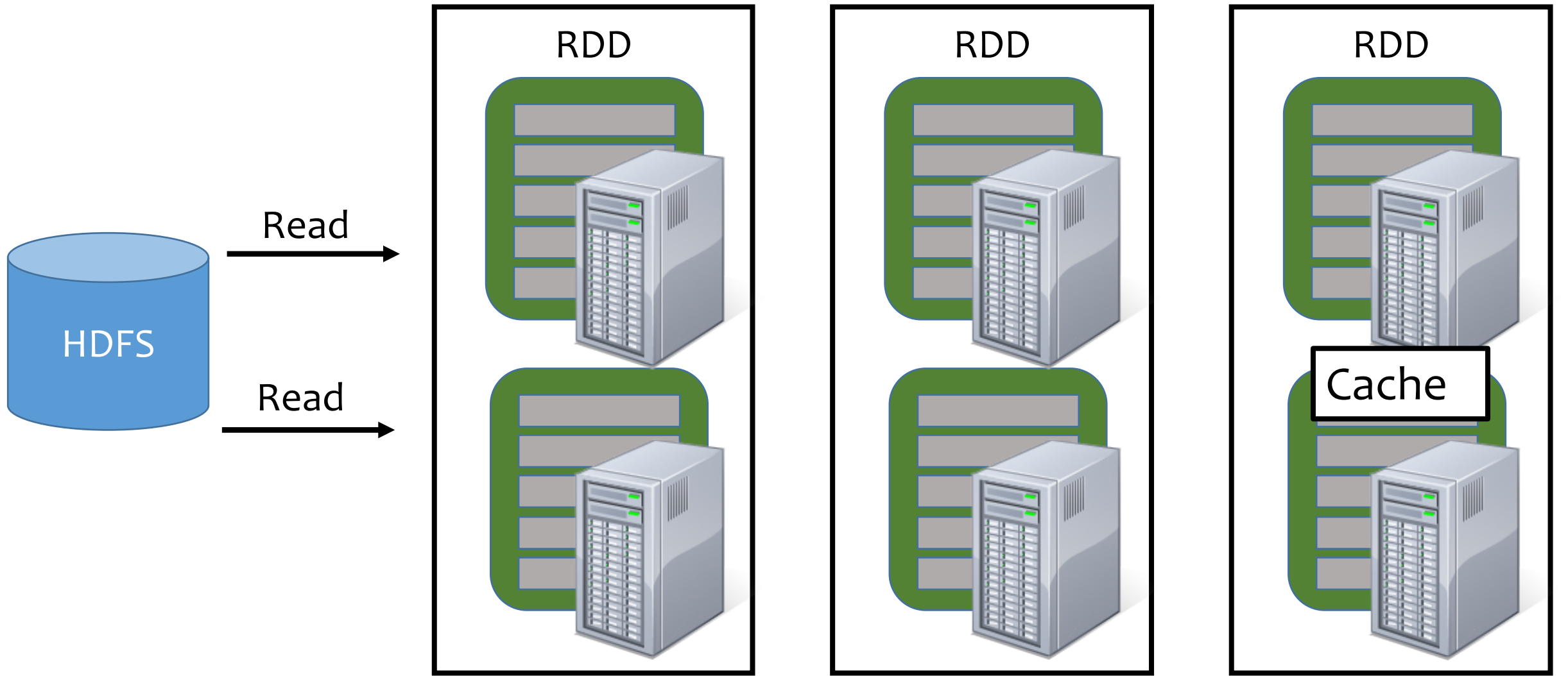



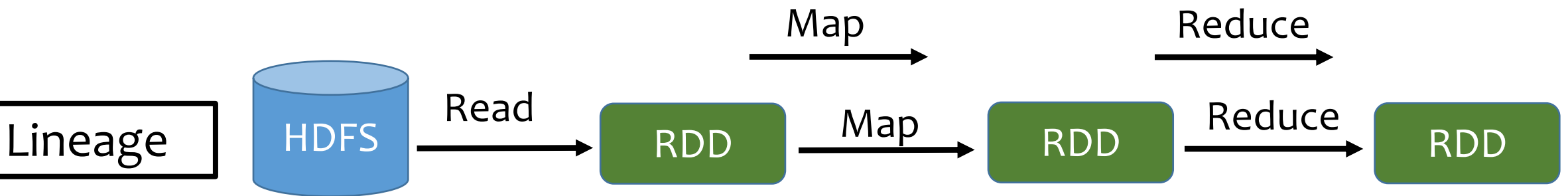
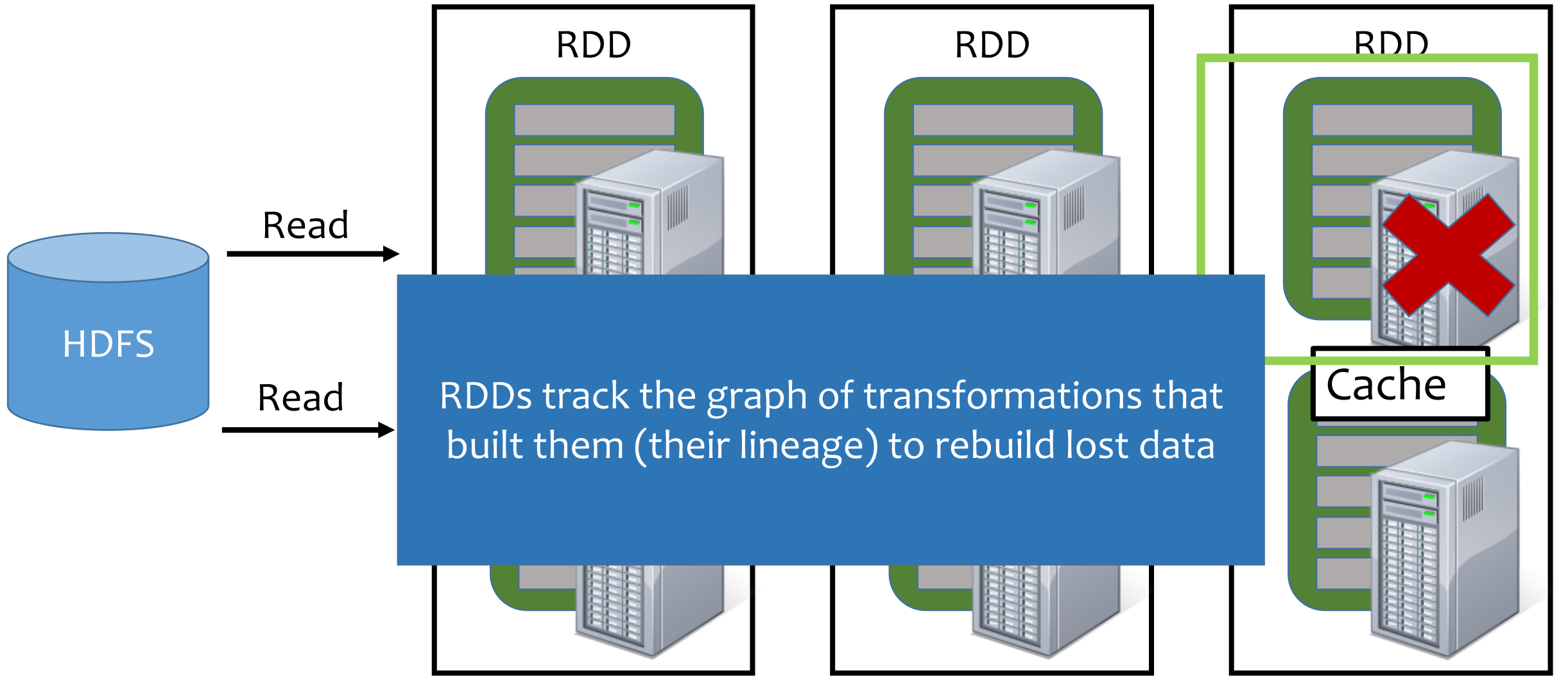

# What can you do with Spark?

- RDD operations
  - Transformations e.g., filter, join, map, group-by ...
  - Actions e.g., count, print ...
- Control
  - Partitioning
  - Persistence

# Partitioning

- PageRank

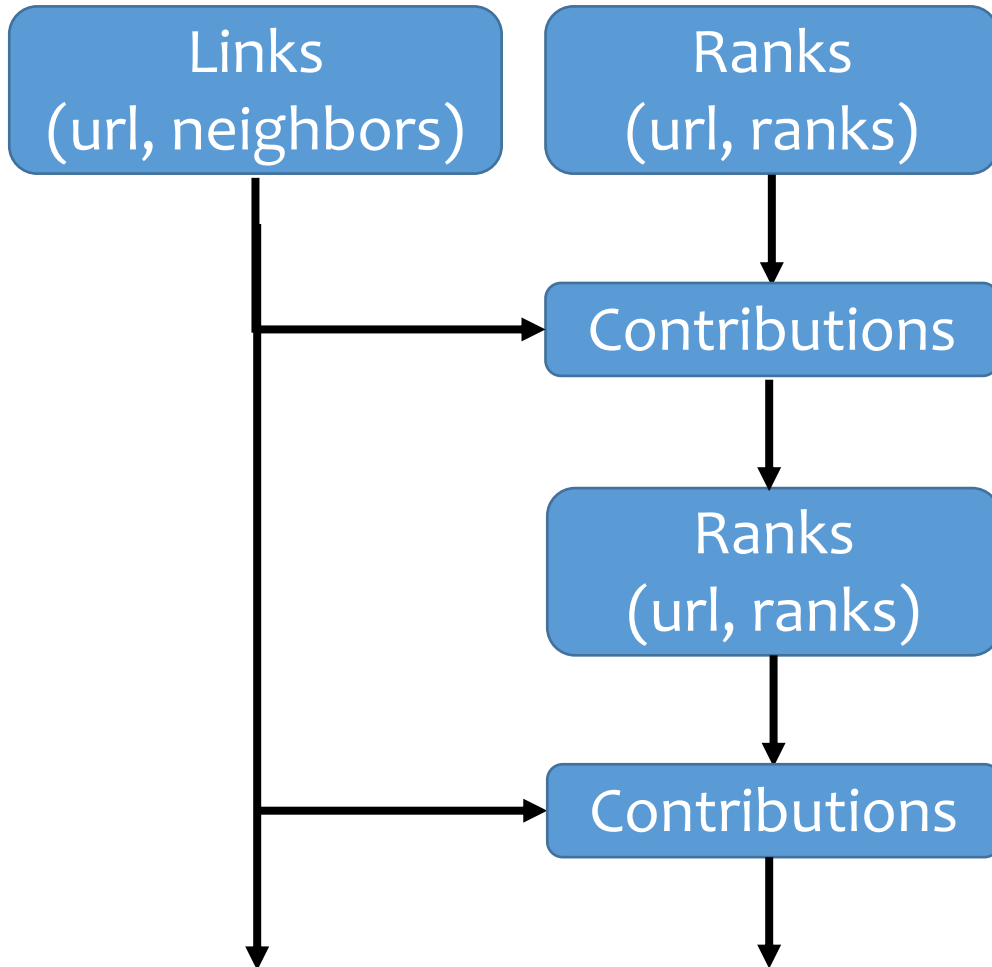

Joins take place repeatedly

Good partitioning reduces shuffles

# Generality

- RDDs allow unification of different programming models
  - Stream Processing
  - Graph Processing
  - Machine Learning .....

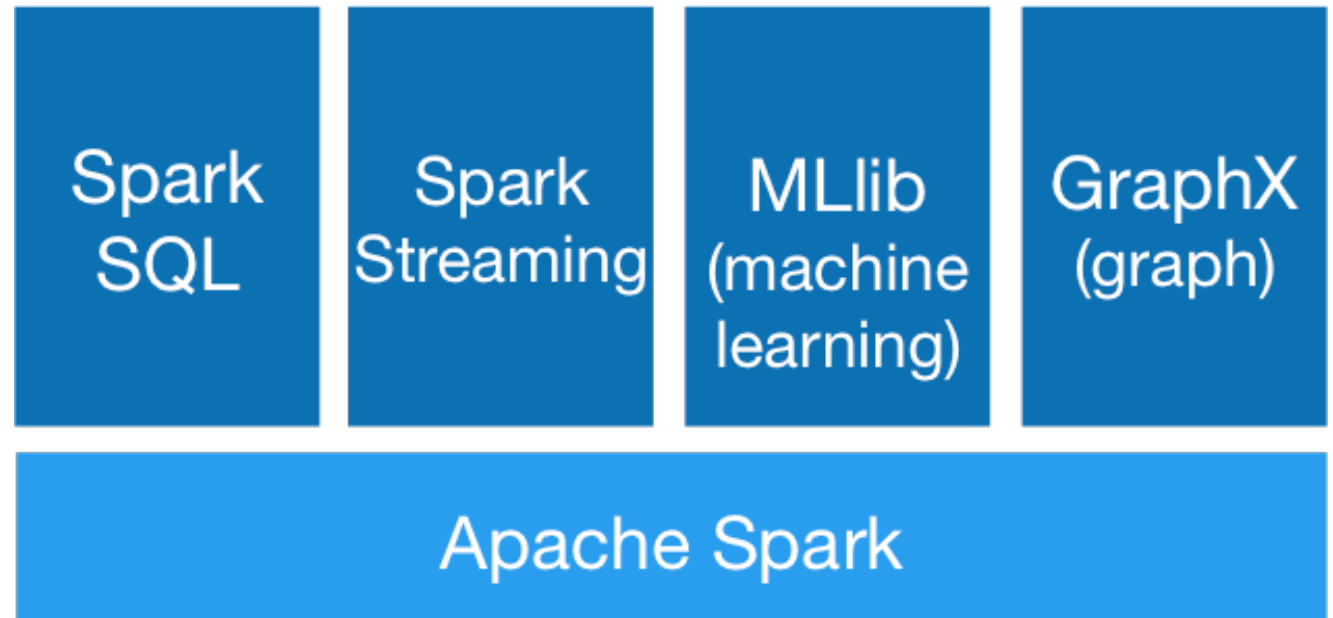

# Gather-Apply-Scatter on GraphX

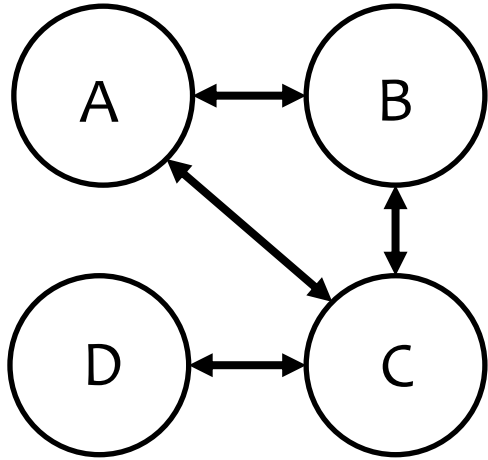

Vertices	Neighbors
A	B
A	C
B	C
D	C

Graph Represented In a Table

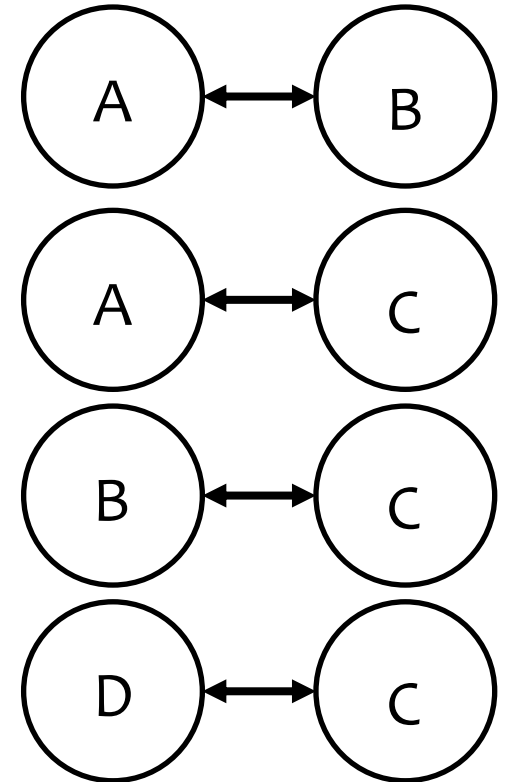
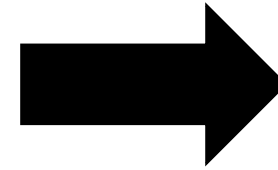

Triplets

# Gather-Apply-Scatter on GraphX

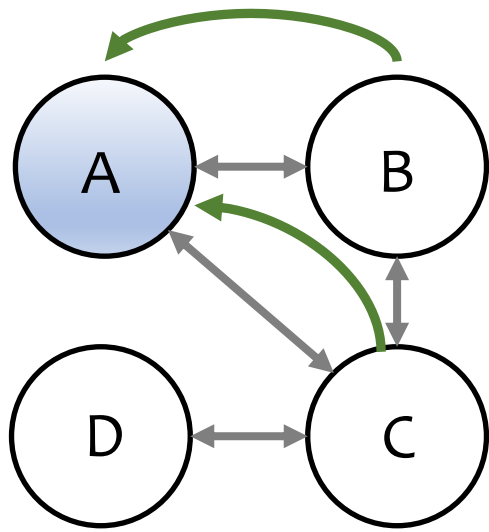

Gather at A

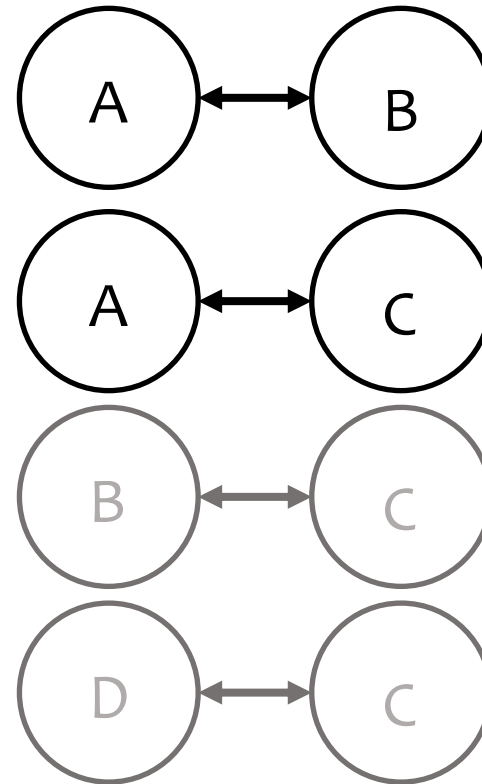

Group-By A

# Gather-Apply-Scatter on GraphX

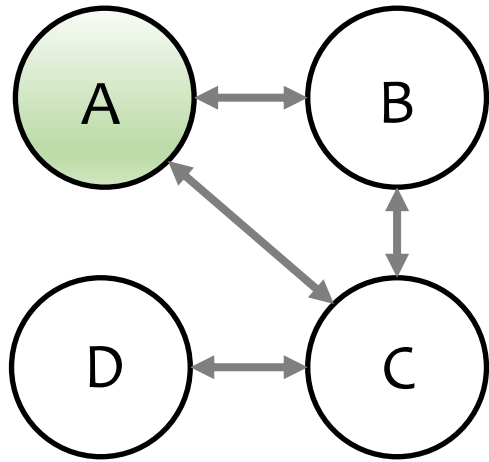

Apply

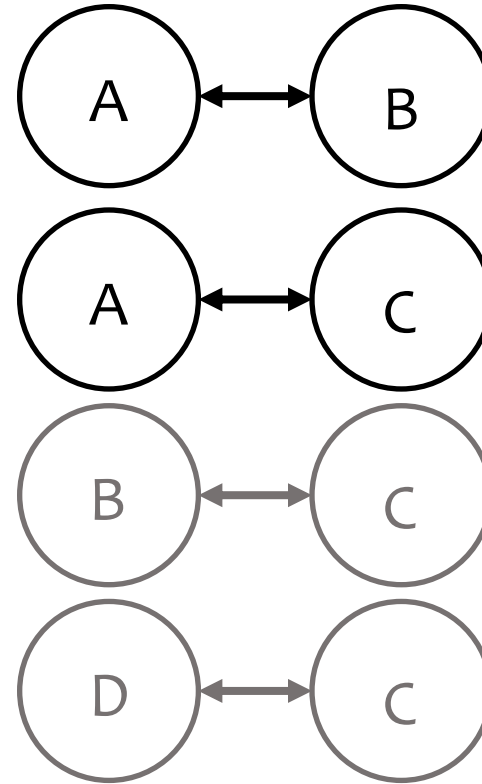

Map

# Gather-Apply-Scatter on GraphX

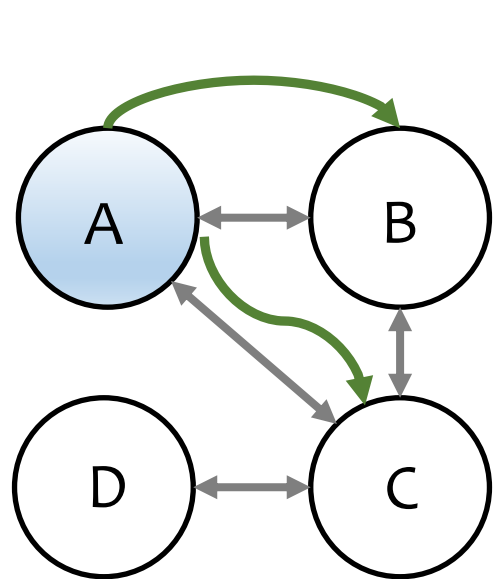

Scatter

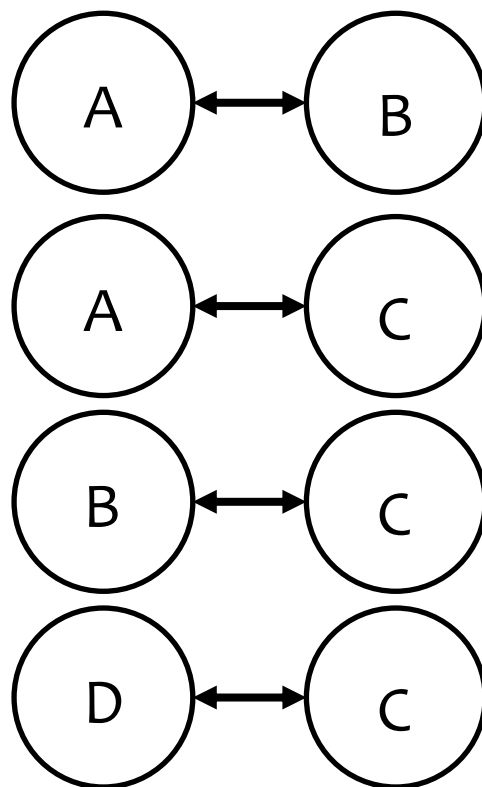

Triplets

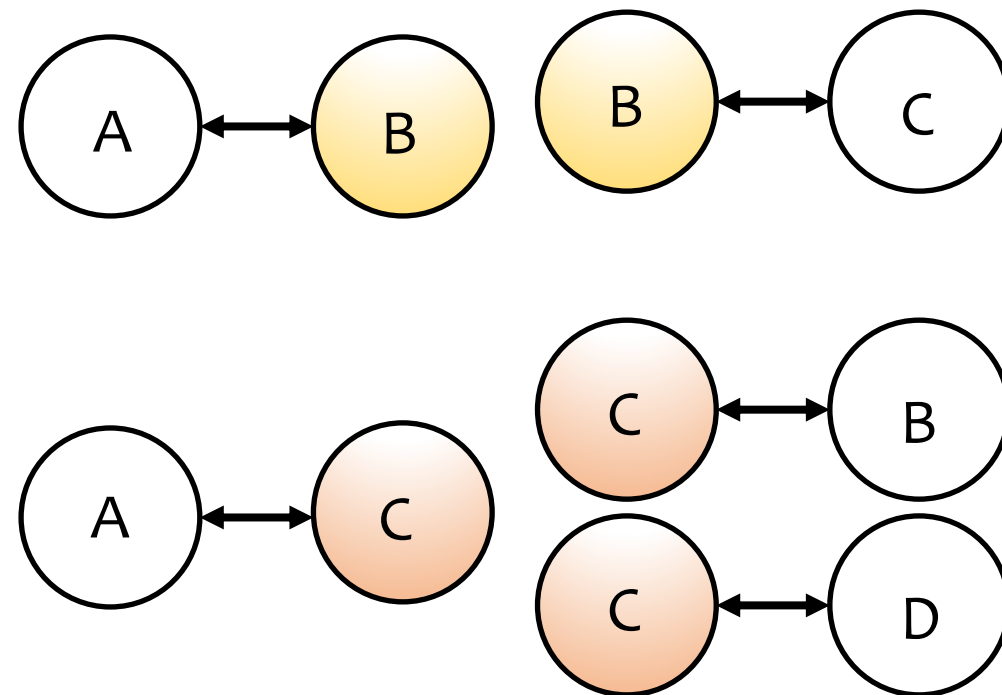

Join



# Summary

- RDDs provide a simple and efficient programming model
- Generalized to a broad set of applications
- Leverages coarse-grained nature of parallel algorithms for failure recovery