

NFAs continued, Closure Properties of Regular Languages

Lecture 5

Wednesday, February 5, 2020

LaTeXed: January 19, 2020 04:14

Theorem

Languages accepted by DFAs, NFAs, and regular expressions are the same.

Theorem

Languages accepted by DFAs, NFAs, and regular expressions are the same.

- DFAs are special cases of NFAs (trivial)
- NFAs accept regular expressions (we saw already)
- DFAs accept languages accepted by NFAs (today)
- Regular expressions for languages accepted by DFAs (later in the course)

Part I

Equivalence of NFAs and DFAs

Equivalence of NFAs and DFAs

Theorem

For every NFA N there is a DFA M such that $L(M) = L(N)$.

Formal Tuple Notation for NFA

Definition

A **non-deterministic finite automata (NFA)** $N = (Q, \Sigma, \delta, s, A)$ is a five tuple where

- Q is a finite set whose elements are called **states**,
- Σ is a finite set called the **input alphabet**,
- $\delta : Q \times \Sigma \cup \{\epsilon\} \rightarrow \mathcal{P}(Q)$ is the **transition function** (here $\mathcal{P}(Q)$ is the power set of Q),
- $s \in Q$ is the **start state**,
- $A \subseteq Q$ is the set of **accepting/final** states.

$\delta(q, a)$ for $a \in \Sigma \cup \{\epsilon\}$ is a subset of Q — a set of states.

Extending the transition function to strings

Definition

For NFA $N = (Q, \Sigma, \delta, s, A)$ and $q \in Q$ the $\epsilon\text{reach}(q)$ is the set of all states that q can reach using only ϵ -transitions.

Definition

Inductive definition of $\delta^* : Q \times \Sigma^* \rightarrow \mathcal{P}(Q)$:

- if $w = \epsilon$, $\delta^*(q, w) = \epsilon\text{reach}(q)$
- if $w = a$ where $a \in \Sigma$
$$\delta^*(q, a) = \cup_{p \in \epsilon\text{reach}(q)} (\cup_{r \in \delta(p, a)} \epsilon\text{reach}(r))$$
- if $w = xa$,
$$\delta^*(q, w) = \cup_{p \in \delta^*(q, x)} (\cup_{r \in \delta(p, a)} \epsilon\text{reach}(r))$$

Formal definition of language accepted by **N**

Definition

A string w is accepted by NFA N if $\delta_N^*(s, w) \cap A \neq \emptyset$.

Definition

The language $L(N)$ accepted by a NFA $N = (Q, \Sigma, \delta, s, A)$ is

$$\{w \in \Sigma^* \mid \delta^*(s, w) \cap A \neq \emptyset\}.$$

Simulating an NFA by a DFA

- Think of a program with fixed memory that needs to simulate NFA N on input w .
- What does it need to store after seeing a prefix x of w ?

Simulating an NFA by a DFA

- Think of a program with fixed memory that needs to simulate NFA N on input w .
- What does it need to store after seeing a prefix x of w ?
- It needs to know at least $\delta^*(s, x)$, the set of states that N could be in after reading x
- Is it sufficient?

Simulating an NFA by a DFA

- Think of a program with fixed memory that needs to simulate NFA N on input w .
- What does it need to store after seeing a prefix x of w ?
- It needs to know at least $\delta^*(s, x)$, the set of states that N could be in after reading x
- Is it sufficient? Yes, if it can compute $\delta^*(s, xa)$ after seeing another symbol a in the input.
- When should the program accept a string w ?

Simulating an NFA by a DFA

- Think of a program with fixed memory that needs to simulate NFA N on input w .
- What does it need to store after seeing a prefix x of w ?
- It needs to know at least $\delta^*(s, x)$, the set of states that N could be in after reading x
- Is it sufficient? Yes, if it can compute $\delta^*(s, xa)$ after seeing another symbol a in the input.
- When should the program accept a string w ? If $\delta^*(s, w) \cap A \neq \emptyset$.

Key Observation: A DFA M that simulates N should keep in its memory/state the **set of states of N**

Thus the state space of the DFA should be $\mathcal{P}(Q)$.

Subset Construction

NFA $N = (Q, \Sigma, s, \delta, A)$. We create a **DFA** $M = (Q', \Sigma, \delta', s', A')$ as follows:

- $Q' = \mathcal{P}(Q)$

Subset Construction

NFA $N = (Q, \Sigma, s, \delta, A)$. We create a **DFA** $M = (Q', \Sigma, \delta', s', A')$ as follows:

- $Q' = \mathcal{P}(Q)$
- $s' = \epsilon\text{reach}(s) = \delta^*(s, \epsilon)$

Subset Construction

NFA $N = (Q, \Sigma, s, \delta, A)$. We create a **DFA** $M = (Q', \Sigma, \delta', s', A')$ as follows:

- $Q' = \mathcal{P}(Q)$
- $s' = \epsilon\text{reach}(s) = \delta^*(s, \epsilon)$
- $A' = \{X \subseteq Q \mid X \cap A \neq \emptyset\}$

Subset Construction

NFA $N = (Q, \Sigma, s, \delta, A)$. We create a **DFA** $M = (Q', \Sigma, \delta', s', A')$ as follows:

- $Q' = \mathcal{P}(Q)$
- $s' = \epsilon\text{reach}(s) = \delta^*(s, \epsilon)$
- $A' = \{X \subseteq Q \mid X \cap A \neq \emptyset\}$
- $\delta'(X, a) = \cup_{q \in X} \delta^*(q, a)$ for each $X \subseteq Q, a \in \Sigma$.

Example

No ϵ -transitions

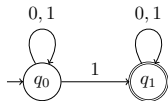

Example

No ϵ -transitions

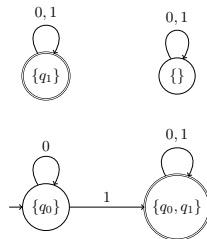
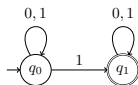

Simulating NFA

Example the first revisited

Previous lecture.. Ran

NFA^(N1)

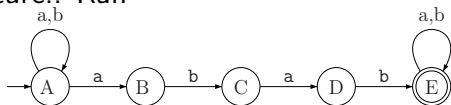

on input *ababa*.

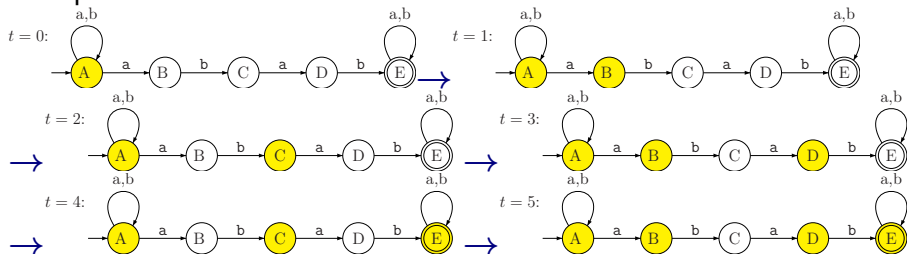

Example: DFA from NFA

NFA:

(N1)

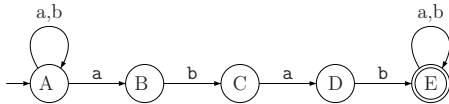

DFA:

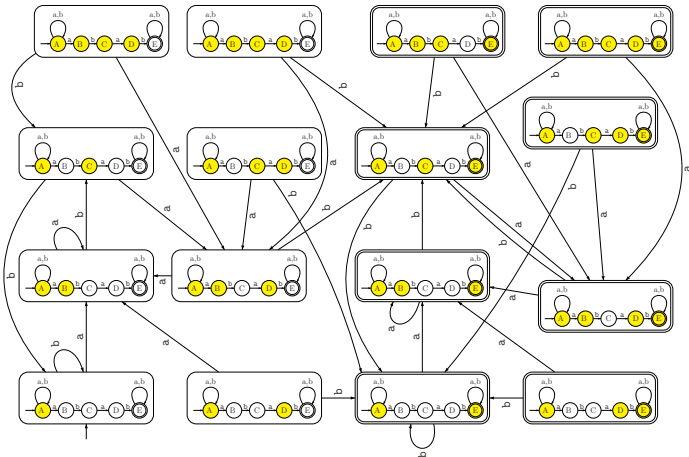

Incremental construction

Only build states reachable from $s' = \epsilon\text{reach}(s)$ the start state of M

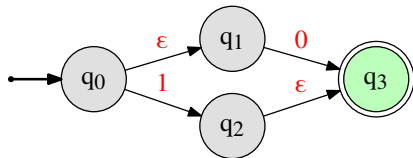

Incremental construction

Only build states reachable from $s' = \epsilon\text{reach}(s)$ the start state of M

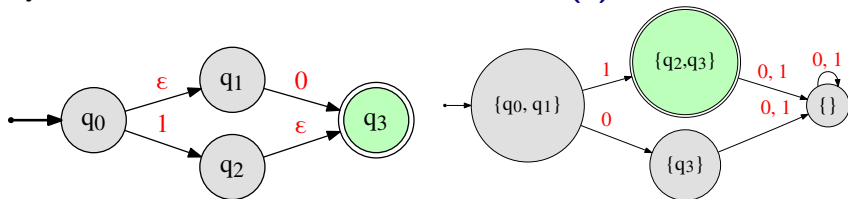

$$\delta'(X, a) = \cup_{q \in X} \delta^*(q, a)$$

Incremental algorithm

- Build M beginning with start state $s' == \epsilon\text{reach}(s)$
- For each existing state $X \subseteq Q$ consider each $a \in \Sigma$ and calculate the state $Y = \delta'(X, a) = \cup_{q \in X} \delta^*(q, a)$ and add a transition.
- If Y is a new state add it to reachable states that need to be explored.

To compute $\delta^*(q, a)$ - set of all states reached from q on *string* a

- Compute $X = \epsilon\text{reach}(q)$
- Compute $Y = \cup_{p \in X} \delta(p, a)$
- Compute $Z = \epsilon\text{reach}(Y) = \cup_{r \in Y} \epsilon\text{reach}(r)$

Proof of Correctness

Theorem

Let $N = (Q, \Sigma, s, \delta, A)$ be a **NFA** and let $M = (Q', \Sigma, \delta', s', A')$ be a **DFA** constructed from N via the subset construction. Then $L(N) = L(M)$.

Proof of Correctness

Theorem

Let $N = (Q, \Sigma, s, \delta, A)$ be a **NFA** and let $M = (Q', \Sigma, \delta', s', A')$ be a **DFA** constructed from N via the subset construction. Then $L(N) = L(M)$.

Stronger claim:

Lemma

For every string w , $\delta_N^*(s, w) = \delta_M^*(s', w)$.

Proof by induction on $|w|$.

Base case: $w = \epsilon$.

$$\delta_N^*(s, \epsilon) = \epsilon\text{reach}(s).$$

$$\delta_M^*(s', \epsilon) = s' = \epsilon\text{reach}(s) \text{ by definition of } s'.$$

Proof continued

Lemma

For every string w , $\delta_N^*(s, w) = \delta_M^*(s', w)$.

Inductive step: $w = xa$ (Note: suffix definition of strings)
 $\delta_N^*(s, xa) = \cup_{p \in \delta_N^*(s, x)} \delta_N^*(p, a)$ by inductive definition of δ_N^*

Proof continued

Lemma

For every string w , $\delta_N^*(s, w) = \delta_M^*(s', w)$.

Inductive step: $w = xa$ (Note: suffix definition of strings)

$\delta_N^*(s, xa) = \cup_{p \in \delta_N^*(s, x)} \delta_N^*(p, a)$ by inductive definition of δ_N^*

$\delta_M^*(s', xa) = \delta_M^*(\delta_M^*(s, x), a)$ by inductive definition of δ_M^*

Proof continued

Lemma

For every string w , $\delta_N^*(s, w) = \delta_M^*(s', w)$.

Inductive step: $w = xa$ (Note: suffix definition of strings)

$\delta_N^*(s, xa) = \cup_{p \in \delta_N^*(s, x)} \delta_N^*(p, a)$ by inductive definition of δ_N^*

$\delta_M^*(s', xa) = \delta_M^*(\delta_M^*(s, x), a)$ by inductive definition of δ_M^*

By inductive hypothesis: $Y = \delta_N^*(s, x) = \delta_M^*(s, x)$

Proof continued

Lemma

For every string w , $\delta_N^*(s, w) = \delta_M^*(s', w)$.

Inductive step: $w = xa$ (Note: suffix definition of strings)

$\delta_N^*(s, xa) = \cup_{p \in \delta_N^*(s, x)} \delta_N^*(p, a)$ by inductive definition of δ_N^*

$\delta_M^*(s', xa) = \delta_M^*(\delta_M^*(s, x), a)$ by inductive definition of δ_M^*

By inductive hypothesis: $Y = \delta_N^*(s, x) = \delta_M^*(s, x)$

Thus $\delta_N^*(s, xa) = \cup_{p \in Y} \delta_N^*(p, a) = \delta_M^*(Y, a)$ by definition of δ_M^* .

Proof continued

Lemma

For every string w , $\delta_N^*(s, w) = \delta_M^*(s', w)$.

Inductive step: $w = xa$ (Note: suffix definition of strings)

$\delta_N^*(s, xa) = \cup_{p \in \delta_N^*(s, x)} \delta_N^*(p, a)$ by inductive definition of δ_N^*

$\delta_M^*(s', xa) = \delta_M^*(\delta_M^*(s, x), a)$ by inductive definition of δ_M^*

By inductive hypothesis: $Y = \delta_N^*(s, x) = \delta_M^*(s, x)$

Thus $\delta_N^*(s, xa) = \cup_{p \in Y} \delta_N^*(p, a) = \delta_M^*(Y, a)$ by definition of δ_M^* .

Therefore,

$\delta_N^*(s, xa) = \delta_M^*(Y, a) = \delta_M^*(\delta_M^*(s, x), a) = \delta_M^*(s', xa)$

which is what we need.

Example: DFA from NFA

NFA: (N1)

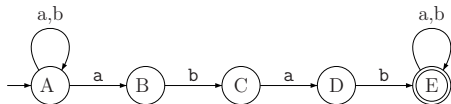

DFA:

Part II

Closure Properties of Regular Languages

Regular Languages

Regular languages have three different characterizations

- Inductive definition via base cases and closure under union, concatenation and Kleene star
- Languages accepted by **DFA**s
- Languages accepted by **NFA**s

Regular Languages

Regular languages have three different characterizations

- Inductive definition via base cases and closure under union, concatenation and Kleene star
- Languages accepted by **DFA**s
- Languages accepted by **NFA**s

Regular language closed under many operations:

- union, concatenation, Kleene star via inductive definition or **NFA**s
- complement, union, intersection via **DFA**s
- homomorphism, inverse homomorphism, reverse, . . .

Different representations allow for flexibility in proofs

Examples: PREFIX and SUFFIX

Let L be a language over Σ .

Definition

$$\text{PREFIX}(L) = \{w \mid wx \in L, x \in \Sigma^*\}$$

Definition

$$\text{SUFFIX}(L) = \{w \mid xw \in L, x \in \Sigma^*\}$$

Examples: PREFIX and SUFFIX

Let L be a language over Σ .

Definition

$$\text{PREFIX}(L) = \{w \mid wx \in L, x \in \Sigma^*\}$$

Definition

$$\text{SUFFIX}(L) = \{w \mid xw \in L, x \in \Sigma^*\}$$

Theorem

If L is regular then $\text{PREFIX}(L)$ is regular.

Theorem

If L is regular then $\text{SUFFIX}(L)$ is regular.

PREFIX

Let $M = (Q, \Sigma, \delta, s, A)$ be a DFA that recognizes L

Create new DFA/NFA to accept $\text{PREFIX}(L)$ (or $\text{SUFFIX}(L)$).

PREFIX

Let $M = (Q, \Sigma, \delta, s, A)$ be a DFA that recognizes L

Create new DFA/NFA to accept $\text{PREFIX}(L)$ (or $\text{SUFFIX}(L)$).

$$X = \{q \in Q \mid s \text{ can reach } q \text{ in } M\}$$

$$Y = \{q \in Q \mid q \text{ can reach some state in } A\}$$

$$Z = X \cap Y$$

Theorem

Consider DFA $M' = (Q, \Sigma, \delta, s, Z)$. $L(M') = \text{PREFIX}(L)$.

SUFFIX

Let $M = (Q, \Sigma, \delta, s, A)$ be a DFA that recognizes L

SUFFIX

Let $M = (Q, \Sigma, \delta, s, A)$ be a DFA that recognizes L

$$X = \{q \in Q \mid s \text{ can reach } q \text{ in } M\}$$

SUFFIX

Let $M = (Q, \Sigma, \delta, s, A)$ be a DFA that recognizes L

$$X = \{q \in Q \mid s \text{ can reach } q \text{ in } M\}$$

Consider NFA $N = (Q \cup \{s'\}, \Sigma, \delta', s', A)$. Add new start state s' and ϵ -transition from s' to each state in X .

SUFFIX

Let $M = (Q, \Sigma, \delta, s, A)$ be a DFA that recognizes L

$$X = \{q \in Q \mid s \text{ can reach } q \text{ in } M\}$$

Consider NFA $N = (Q \cup \{s'\}, \Sigma, \delta', s', A)$. Add new start state s' and ϵ -transition from s' to each state in X .

Claim: $L(N) = \text{SUFFIX}(L)$.

Part III

DFA to Regular Expressions

DFA to Regular Expressions

Theorem

Given a DFA $M = (Q, \Sigma, \delta, s, A)$ there is a regular expression r such that $L(r) = L(M)$. That is, regular expressions are as powerful as DFAs (and hence also NFAs).

- Simple algorithm but formal proof is involved. See notes.
- An easier proof via a more involved algorithm later in course.

Stage 0: Input

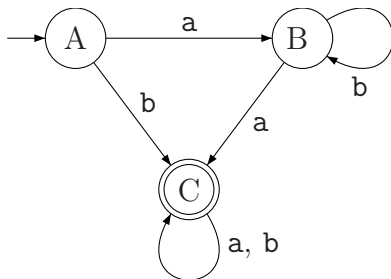

Stage 1: Normalizing

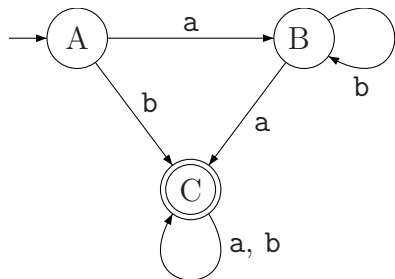

2: Normalizing it.

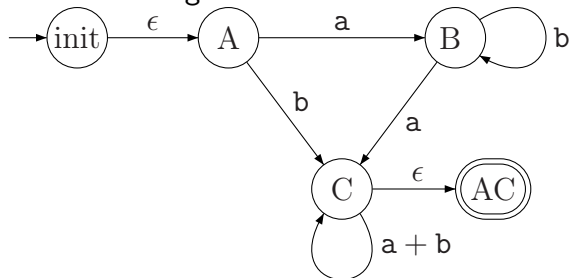

Stage 2: Remove state A

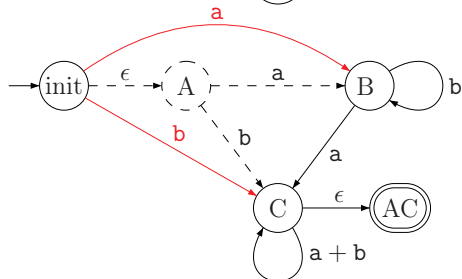
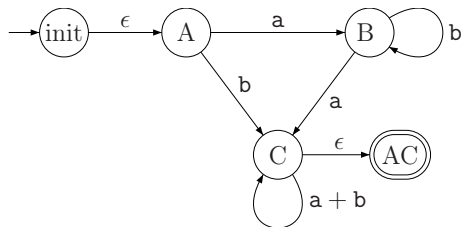

Stage 4: Redrawn without old edges

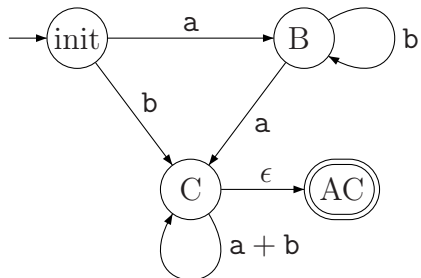

Stage 4: Removing B

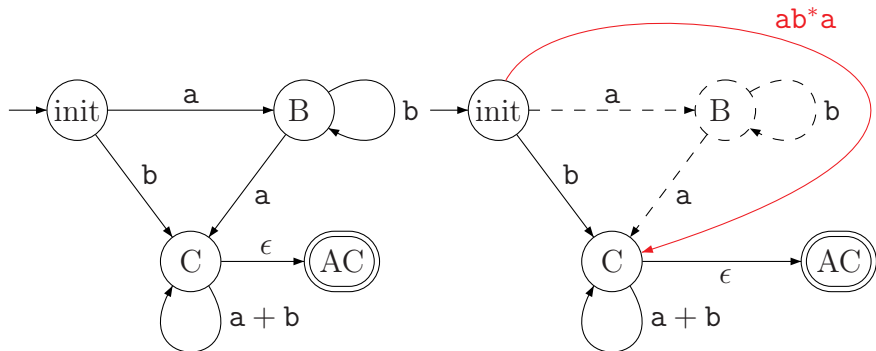

Stage 5: Redraw

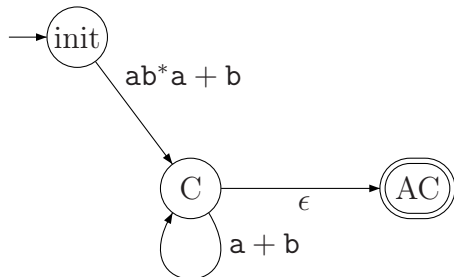

Stage 6: Removing C

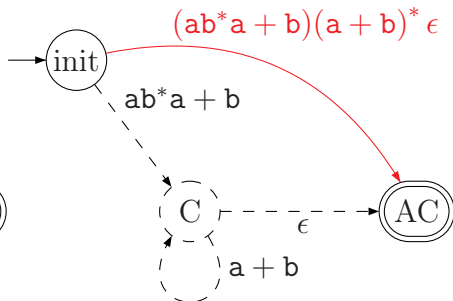
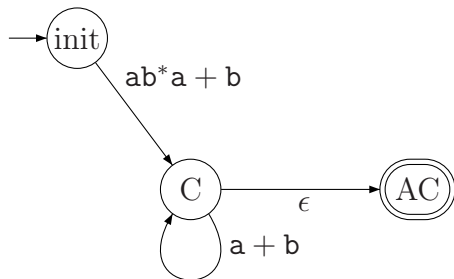

Stage 7: Redraw

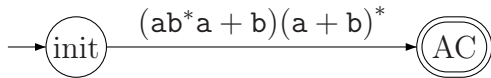

Stage 8: Extract regular expression

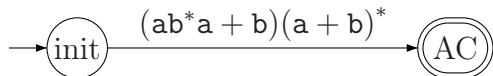

Thus, this automata is equivalent to the regular expression $(ab^*a + b)(a + b)^*$.