

Communicating in Science— Celia's Tips for Science Talks

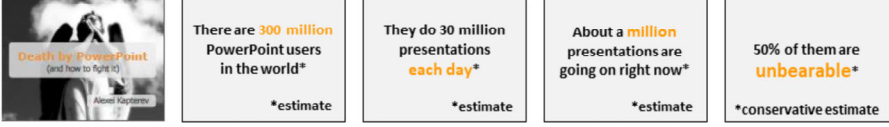

There are **300 million** PowerPoint users in the world*
*estimate

They do **30 million** presentations **each day***
*estimate

About a **million** presentations are going on right now*
*estimate

50% of them are **unbearable***
*conservative estimate

"Death by PowerPoint"
Alexei Kaptarev
<http://www.slideshare.net/thecroaker/death-by-powerpoint/>

Celia M. Elliott
Department of Physics
University of Illinois at Urbana-Champaign

© 2023 Board of Trustees of the University of Illinois
All rights Reserved



Today, we'll look at some ways to enhance the communications value of your slides and some tips to avoid humiliation.

The standard software for most scientific talks is MS PowerPoint. Like it or hate it, that's what nearly all AV systems at conferences are set up to use. If you are determined to be an iconoclast and use some other presentation software, fine, but be prepared for last-minute technical difficulties that will annoy your colleagues and cut into your presentation time. If you demand to use something other than PPT, take a PDF version of your talk that you can use when the computer in the seminar room can't run *Photoshop* or *LibreOffice*.

Alexei Kaptarev's *Death by Powerpoint* is an Internet classic not to be missed:
<http://www.slideshare.net/thecroaker/death-by-powerpoint/>

Before you turn on PowerPoint

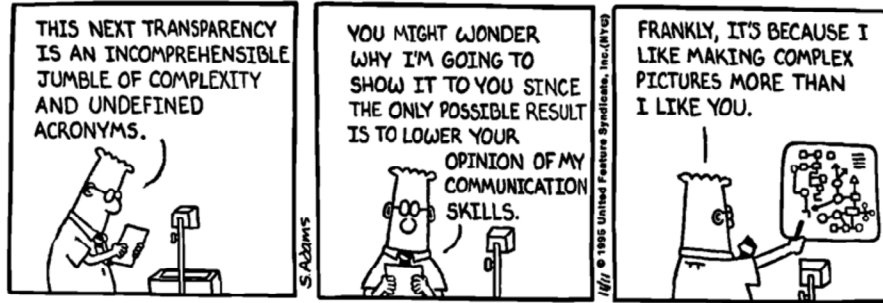

Determine your goal(s) for the talk

Consider your audience

Essentials for preparing your talk

Know your audience!

**Determine the style of your talk;
what structure best fits your audience and
your message?**

Find out how much time you have to speak

**Decide on the key points you want to
communicate**

**Determine how best to use figures to
illustrate your key points**

**Allow time for rehearsal, feedback, and
revision**

3

This slide is a horrible example—**do not** present slides that look like this at your talk. It has way too much text and zero visual interest. It tells your audience “I might be able to be more boring, but I frankly don’t think it’s worth finding out for the likes of you.”



Essentials for preparing your talk

- Know your audience!**
- Determine the style of your talk and what structure best fits your audience and your message?**
- Find out how long you have to speak**
- Decide on the topics you want to cover**
- Determine how best to use figures to illustrate your key points**
- Allow time for rehearsal, feedback, and revision**

4

This slide is a horrible example—**do not** present slides that look like this at your talk. It has way too much text and zero visual interest. It tells your audience “I might be able to be more boring, but I frankly don’t think it’s worth finding out for the likes of you.”

**Before you start the first slide,
decide what your ultimate goal is**

Disseminate a new result

Provide an overview of the topic

Reinterpret existing results

Propose a new experiment

Explain a new concept or method

Stimulate new collaborations

Educate the audience on a specific concept

Get a job

**Overarching goal: Tell a memorable story &
teach the audience something interesting** 5



A common error that beginning researchers make is that they emphasize what they found most interesting, or what they spent the most time doing, and not what the **audience wants to know**.

Know thy audience! It's absolutely critical to producing a successful talk or paper (or anything else).

For many of the talks you will give or papers you will write as a scientist or engineer, nobody listening or reading will know as much about the subject as you do. You don't have to dumb-down your messages, but you do have to draw your listener in and explain things in terms s/he can understand.

So the first rule of effective scientific communications is understand your audience. Who are they? What do they want to know? What do they already understand? What is going to confuse them? What will engage their interest?

Good advice from Elmore Leonard: "Try to leave out the part that readers tend to skip." (Elmore Leonard's Rules for Writers, 24 Feb 2010, <http://www.guardian.co.uk/books/2010/feb/24/elmore-leonard-rules-for-writers>)

Another consideration as you analyze your audience: think about cross-cultural implications. The use of humor, references to popular culture, and sports analogies are very culture-specific. Will your audience understand your reference to the Kansas City Chiefs or *Dancing with the Stars*?

Your biggest constraint: How much material can you cover in the time allotted for your talk?

Elliott equation:

$$p = \frac{t}{8}, \quad [1]$$

7

The amount of time you're allotted determines how much material you can cover in your talk.

It takes about 6 to 8 minutes to adequately introduce, explain, and summarize one major idea or point in a scientific talk.

N.B. Equation [1] is also about as complicated as anything you'd want to show in a talk. Think about how long it took you to process and understand the point that was being made in this slide, using an equation. Do you really want to tackle

$$\left. \frac{\partial f}{\partial t} \right|_{\text{coll}} = \iint g(\mathbf{p} - \mathbf{p}', \mathbf{q}) [f(\mathbf{x}, \mathbf{p} + \mathbf{q}, t) f(\mathbf{x}, \mathbf{p}' - \mathbf{q}, t) - f(\mathbf{x}, \mathbf{p}, t) f(\mathbf{x}, \mathbf{p}', t)] d\mathbf{p}' d\mathbf{q} ?$$

Your biggest constraint: How much material can you cover in the time allotted for your talk?

Elliott equation:

$$p = \frac{t}{8}, \quad [1]$$

The number of main points you can make in an oral presentation

Your biggest constraint: How much material can you cover in the time allotted for your talk?

Elliott equation:

The time allotted in minutes

$$p = \frac{t}{8}, \quad [1]$$

Tip: It takes at least 6 to 8 min to adequately introduce, explain, illustrate, give examples of, and summarize a major point in an oral talk

9

Eschew amateur mistakes

Covering too much material

Including excruciating detail

Compensating by skipping slides or talking faster

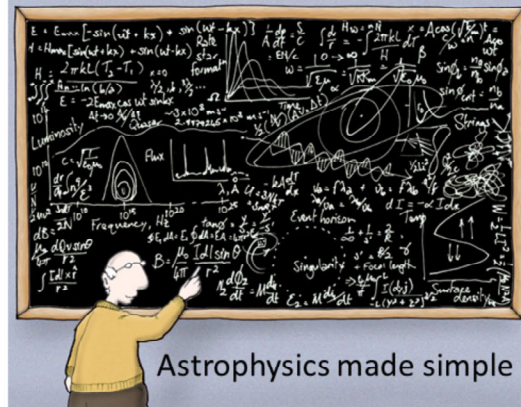

Don't try to tell "the whole story"*



*Your objective is to get the audience interested enough to remember your name and read the paper

Distill your talk to a few key points (q.v. Eq. 1)

Present only enough data to

Illustrate your main points

Support your conclusions

Demonstrate the originality of your work

11

A talk is not your paper projected onto the wall.

Your job as a speaker is to thoughtfully select the important points in the paper and convey them in a way that is meaningful and memorable for the audience.

More presentation math:

$$S = \frac{t}{2},$$

[2]



where S is the number of slides that can be presented, and t is the time allotted in minutes

A good “rule of thumb” is to allow about 2 minutes per slide

Allow more time for equations, complex plots, complicated figures, tabular data

Tip: You cannot show 44 slides in a 15-min presentation, *no matter how fast you talk*

12

The amount of time you're allotted also determines the number of slides you should prepare. In general, allow at least 2 min per slide, and more time for slides that present equations, plots, complex figures, or tabular data.

How do you start?—with the ideas!

What are the (2 or 3, at most) main ideas that I want to convey to the audience?



What is the best (easiest to understand, most memorable) way to show them that information?*

***Hint: It's probably not by written words that you read off the screen**

13

The introductory material flows from these ideas :

- What motivated the work? How does it fit into work that has already been done?
- What background information does the audience need to understand these points?

The body of the presentation also flows from these ideas:

- What supporting evidence and data must be presented?
- How can you most effectively present those data—in text, figures, graphs, equations?

N.B. In most cases, “text” is the worst way to convey scientific data.

For a wonderful introduction to how to present quantitative information, see Edward Tufte's *Visual Explanations* (Cheshire, CT, Graphics Press, 1997).

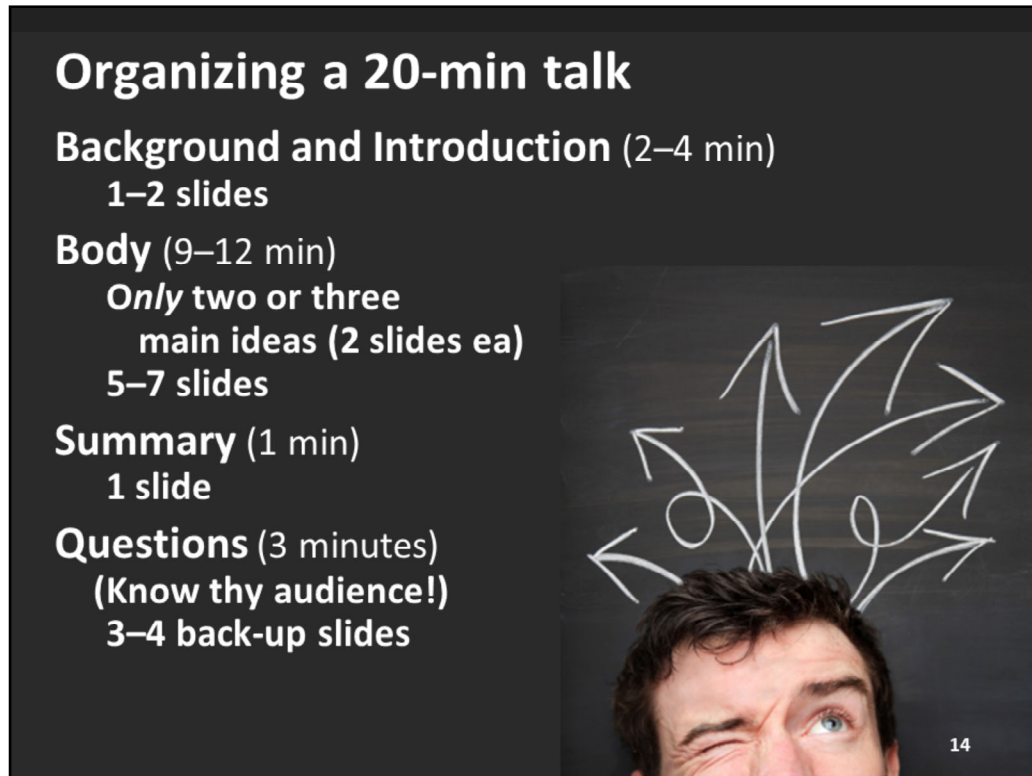

Organizing a 20-min talk

- Background and Introduction (2–4 min)**
1–2 slides
- Body (9–12 min)**
Only two or three main ideas (2 slides ea)
5–7 slides
- Summary (1 min)**
1 slide
- Questions (3 minutes)**
(Know thy audience!)
3–4 back-up slides

14

Follow some simple “rules of thumb”:

If you’d write or draw something on the blackboard or a piece of paper while explaining your ideas to a friend, make a graphic of it.

Back-up slides; consider likely questions or objections and make a slide to answer each of them. (Knowing your audience includes anticipating what questions they’ll ask.)

Allotted <20 minutes? **Make fewer slides**, don’t talk faster.

Write out main ideas in full sentences

The sentences become slide titles
—one main idea per slide →

Use the rest of the slide to explain and support the statement at the top of the slide →

Tip: Read the sentences one after the other. Do they form a logical narrative? In "outline" view, moving slides around to ensure a logical story is easy!

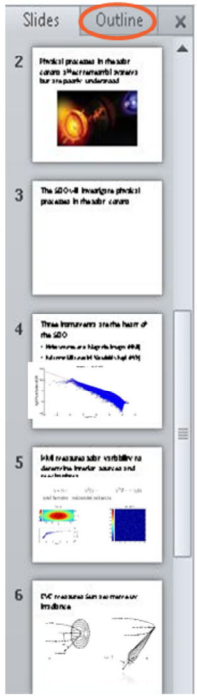

15

These key sentences encapsulate your whole talk; they provide the motivation, describe the methods, highlight the key results, explain your conclusions.

Arrange the key sentences, one per slide, and move them around until you have a logical, coherent narrative story line.

Every other element that you put on the slide should explain or amplify the motivating statement

Realization of TI state in Bi_2Te_3
Y. L. Chen, et. al., *Science* 325, 178 (2009)

Crystal Structure
Te (green), Bi (red)
Quintuple layer sandwich structure
Te1, Bi, Te2, Bi, Te1
Quintuple layer sandwich structure
Te1, Bi, Te2, Bi, Te1

Bulk band structure
Band structure plot showing energy (eV) vs momentum (K, Γ , M). Labels include BCB and BVB.

Bulk Fermi surface (n-type)
Fermi surface plots for k_x, k_y, k_z (1/\text{Å}) showing Dirac fermions.

Should be larger and not in red → **TI Checklist:**

1. There exist Dirac surface states
2. There are odd number of Dirac fermions in a Brillouin Zone
3. The E_F is in the gap

Yulin Chen, "Direct Probing the Electronic Structures of Topological Insulators,"
Tutorial on topological insulators, APS March meeting, 2011
http://www.stanford.edu/~chenyl/APS_Tutorial_2011_YulinChen.pdf

16

People read slides from top down, and they'll look at the words at the top of the slide first. Make it state one of your key points. People pay the most attention at the top of each new slide. Keep them engaged and interested by what they look at next. Make it the supporting evidence for your statement.

**Now, putting together effective,
memorable slides...**

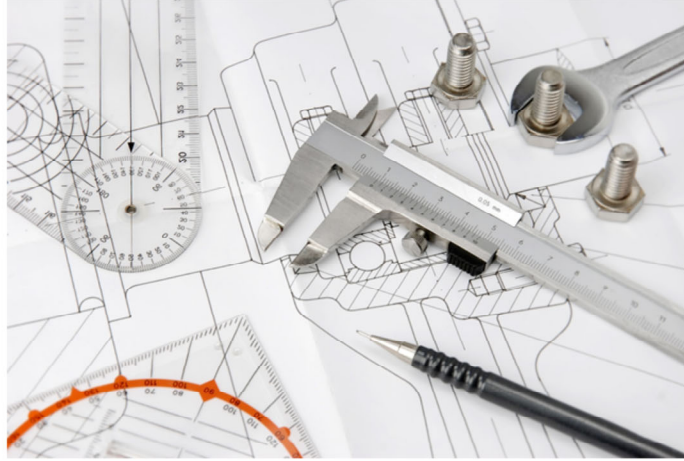

First, the “don’ts”...

17

Don't use photographic or "fill" backgrounds

 **Yes, it's Illini Orange, but nobody can read the text**

They're distracting
They make your text too hard to read
They get boring after the first two or three

 **Even if your talk is about koalas**

 **Even if it's on hydrophobic materials**

 **Even if you think it looks really cool**

Just don't do it! 18

Don't use photographic or textured backgrounds—just don't do it. They're distracting, they get boring after you've seen the first one, and the superimposed text is often impossible to read.

Don't use one of the PPT templates
They take up too much real estate with meaningless graphics
They force you to devote 25% of the slide to the "title"
They trivialize your message by promoting style over substance
Many are just hideous



The image shows three examples of PPT templates, each with a title 'TITLE AND CONTENT LAYOUT' and a bar chart. The first template has a green background with a large, decorative title box on the left and a bar chart on the right. The second template has a purple background with a large, decorative title box at the top and a bar chart below it. The third template has a blue background with a large, decorative title box at the top and a bar chart below it. Red circles highlight the excessive title boxes and the bar charts in each example.

You want the audience to be thinking about what you're saying and looking at the evidence you're presenting, not swooning (or snickering) over your artistic taste.

Don't use  **unless you are presenting an actual list**

Status of Projects



HEP at ANL

Theory

- Connection with UC through Carlos Wagner (app) has brought two thesis students to
- New Assistant level theorist (Tim T)
- 7 international workshops organized
- Broad participation by students
- Active work on organizing
- workshops held at
- Physics high

Accelerator Physics

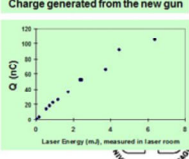
- B... Wakefield
- ...beam configurations,
- major developments of the
- ... of acceleration to 100 MeV in 1m
- ... required a major upgrade of their facility, especially
- electron gun and laser system
- High power tests of externally powered dielectric loaded waveguides in collaboration with Naval Research Laboratory
- 2 new physics processes affecting electron acceleration discovered (and published)



24 20

I recommend turning off the “bullet list” format, which is the default in PPT. Presenting ideas in bulleted lists implies hierarchies or relationships that may not, in fact, exist.

“Lists can communicate only three logical relationships: sequence (first to last in time), priority (least to most important, or vice versa), or simple membership in a set (these items are related to one another in some way, but the nature of that relationship remains unstated). A list can show only one of those relationships at a time.” Gordon Shaw, Robert Brown, Philip Bromiley, “Strategic Stories: How 3M is Rewriting Business Planning,” *Harvard Business Review* 76, 42–44 (1998).

Turning off the bullets also gives you more slide real estate to work with.

Don't use red or green to convey important information*

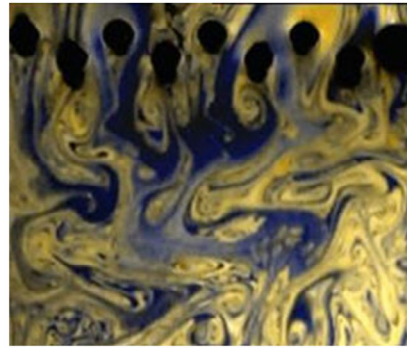
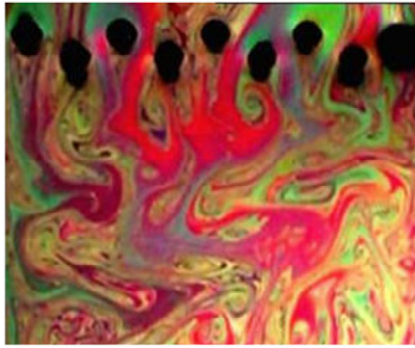

Development of turbulence in a soap film as its surface is raked by a wire comb. *Courtesy Nigel D. Goldenfeld*

***Between 8 and 12 percent of white males are red-green colorblind—who's your audience?**

21

If you use color to convey information, make sure that information transfers as you intended it and is accessible to everyone in your audience. You can upload a figure to <https://www.color-blindness.com/coblis-color-blindness-simulator/> and see how the figure will look to people with the most common forms of colorblindness.

Another good resource is <http://www.colourblindawareness.org/colour-blindness/>.

DO replace the content-less PPT “title” with a meaningful motivating statement

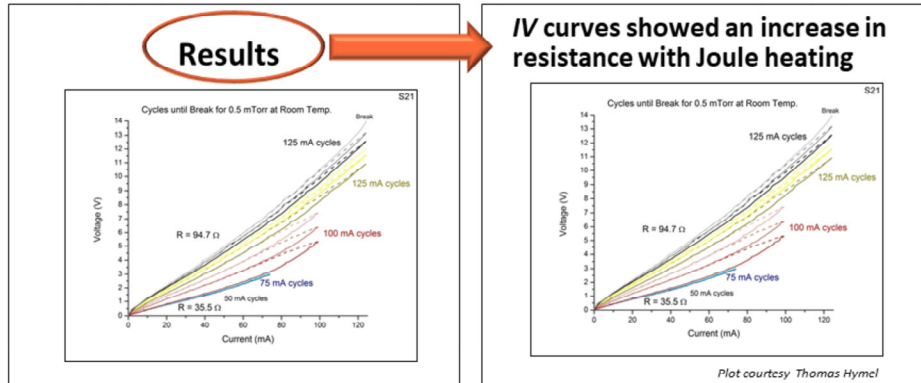

Tip 1: Write the statement as a sentence and left-justify it

Tip 2: Turn off the “auto-correct” feature in PPT that reduces the font size if you exceed the number of characters MS thinks you should have on a line

22

The default for PowerPoint slide “titles” is centered. Change it to left-justified.

Turn off the automatic “fitting” functions in PPT to avoid having PPT reduce your font size if you exceed the number of characters MS thinks you should have on a line.

From the “File” menu, click on the “Options” link, and then select “Proofing” from the menu. In the dialogue box, click on the “Autocorrect Options” button. When that dialogue box opens, uncheck the “Autofit Title” and “Autofit Body Text” boxes.

DO label all elements in a figure
Point out important features
Label both axes of graphs and show units
Provide a scale
Give credit

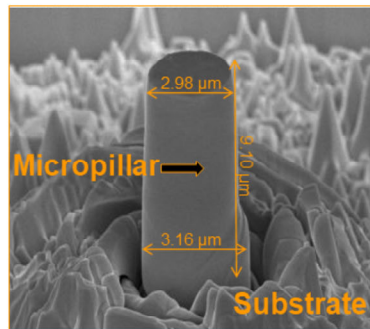

SEM image of gold micropillars
(Courtesy M. Wraith)

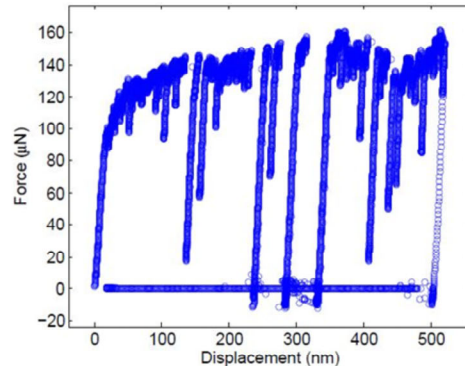

Displacement controlled
compression of the micropillars 23
(Courtesy M. Wraith)

What about captions? Every figure in a paper **must** have a caption that explains the figure and points out important features. Some scientists say that figures for talks don't require captions or labels—you're standing there explaining them, after all.

I, however, think images in talks should have short, explanatory captions that orient the audience. They're going to look at the picture on the slide first—before you explain it—and they're going to want to know immediately what is being depicted.

If you've used somebody else's figure, you should at a minimum give credit for it, and perhaps provide a URL or bibliographic reference for where the original may be found.

Another tip for ALL figures—if you show a photograph or drawing of something, provide some sort of visual clue to its scale. The audience may have no idea if the apparatus shown below is 5-cm long or 5-m long from just looking at this image.

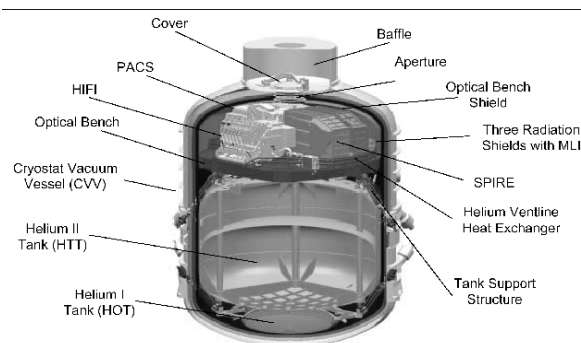

DO use the SEEE method to present your ideas effectively

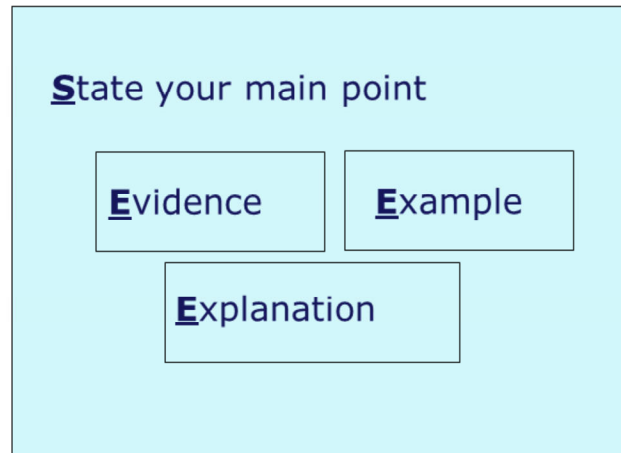

24

Put a motivating statement at the top of your slide that summarizes the point of the slide.

People pay attention when something changes in their environment—for instance, when a slide changes. Take advantage of that sharpened attention to articulate your message in an immediately identifiable, memorable way.

Use the rest of the slide to explain, give evidence for, or provide examples of the idea presented in the motivating statement at the top of the slide.

DO use the SEEE method to present your ideas effectively

State your main point

Evidence

Ex

Explanatio

Study of nucleon spin structure requires high-timing-resolution detector

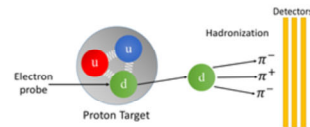
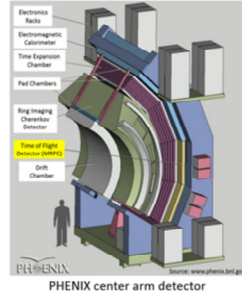

$$p = \gamma m_0 \beta c$$

$$\sigma(m^2) = 2E^2 \frac{\sigma_T}{\tau}$$

High timing resolution \rightarrow high mass resolution
 \rightarrow better particle identification

Goal: To develop a cost effective multigap resistive plate chamber (MRPC) having high timing resolution.

Courtesy Jun Hui See Toh

Use the rest of the slide to explain, give evidence for, or provide examples of the idea presented in the motivating statement at the top of the slide.

DO number your slides

“viz.” (*videlicet*) means “namely”*

Use to introduce specifically the items comprised by a previously expressed whole

“The noble gases, **viz.**, helium, neon, argon, krypton, xenon, and radon, are a group of six gaseous chemical elements constituting Group 18 of the periodic table.”

*Few writers use viz. nowadays, but know what it means



26

Numbering your slides helps both you and your audience.

1. You can mentally keep track of whether you are in the presentation by periodically checking the slide number against the total number of slides in your talk vs the amount of time remaining in your talk and adjust your pace accordingly.
2. A questioner can note the number of the slide he wants to ask about during the Q&A. By identifying by number which slide to refer to, the questioner can significantly cut the time that the speaker spends fumbling around trying to figure out which slide is meant. “Can you show that slide again that has the plot on it? [*Seven slides show plots.*]. No, not that one, the one that shows the intensity. No, that’s not it either. The one that showed the *B* field in green...”

vs.

Could you please show Slide 32 again?

Use a simple sans serif font

Calibri Tahoma
Helvetica Corbel
Arial Verdana

Serif fonts don't project as well because the narrow parts tend to fade

Eschew weird fonts (in *italics**)

Use one main font. At most, one contrast font for emphasis

Use one font size. At most, one contrast font for emphasis

Use mixed upper and lower case for text—
WRITING IN ALL CAPS LOOKS LIKE YOU'RE SHOUTING (and it's much harder to read—and proofread!)

REJECTED

*or risk professional ridicule

27

Do as I say, not as I do. This slide, while typical of an academic lecture to facilitate note-taking, has **w-a-a-a-a-y** too much text on it for a science talk.

Keep text to a minimum—use just enough words to orient the audience to what they are seeing. You want them to be listening to you, not reading a novella off the screen.

Use equations only if absolutely necessary to convey your message



Photon Fluctuations

DARK ENERGY SURVEY

- After PSF and normalization, must simulate photon fluctuations
- Convert each pixel ADC count to number of photons by gain of each pixel
- Apply Poisson distribution errors to each pixel
- Convert number of photons back to ADC counts

$$\text{New ADC value} = \frac{\text{Poisson}(\text{Gain} * \text{Old ADC Value})}{\text{Gain}}$$

- Finally, superimpose SN onto image

Slide Courtesy: Mck Lempeller

**Replace
math
with
words**

Slow down; talk through step by step
Explain relevance
Make them large enough to be easily read
Define your terms

28

PowerPoint animations can be useful in presenting equations:

- Highlight relevant terms in different colors
- Drop out terms
- Replace symbols with words
- Blow up parts of the equation or use arrows as pointers as you walk the audience through it

“Embed” special fonts in PPT to avoid embarrassing surprises at the conference

your computer

The Strickler–Berg relation opens the door for comparing measured spectral quantities

$$1/\tau_{FM} = 2.88 \times 10^{-9} \frac{n_f^3}{n_a} \langle \bar{\nu}_f^3 \rangle_{av}^{-1} \int \frac{\epsilon d\bar{\nu}}{\bar{\nu}}$$

Different computer—Voilà! Pencils!

conference computer

The Strickler–Berg relation opens the door for comparing measured spectral quantities

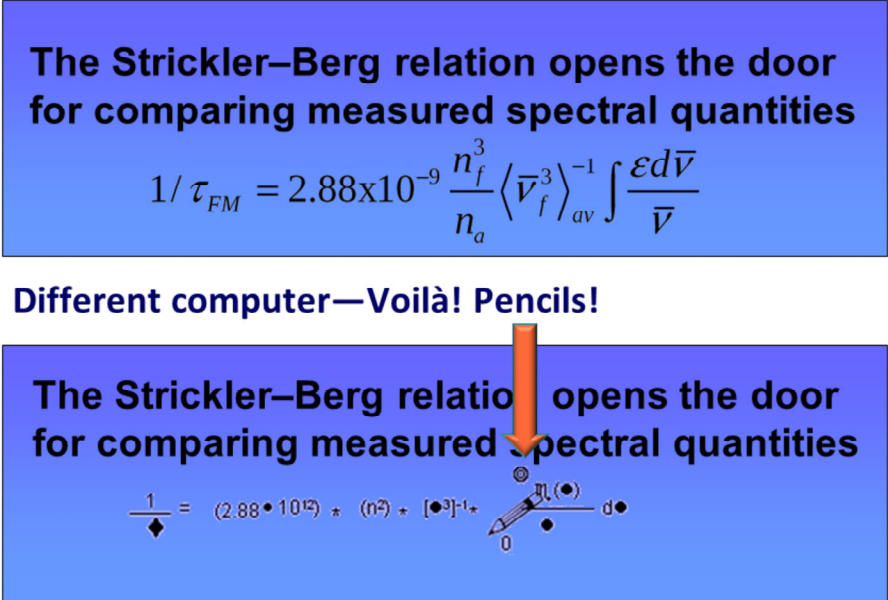
$$\frac{1}{\tau_{FM}} = (2.88 \cdot 10^{12}) * (n_f^3) * [\bar{\nu}_f^3]^{-1} * \int \frac{\epsilon d\bar{\nu}}{\bar{\nu}}$$

29

Every computer has its own individual “library” of fonts; if PPT cannot find a font when you open your presentation on a different machine, it just arbitrarily substitutes a font that it thinks is “close.” Often, it isn’t...

Choose a neutral background and a high-contrast color for the text

Use a light-colored background with dark text

Use a dark background with light text

This isn't high-enough contrast

Neither is this

Don't ever put red on blue

Or blue on red

And avoid using gradient fills, too

30

Be aware that colors that look bright and crisp on your monitor may look entirely different when projected. In particular, pastel colors and thin lines fade away. Use bright, primary colors, bold fonts, and thick lines.

Most people will remember your images better than your words...

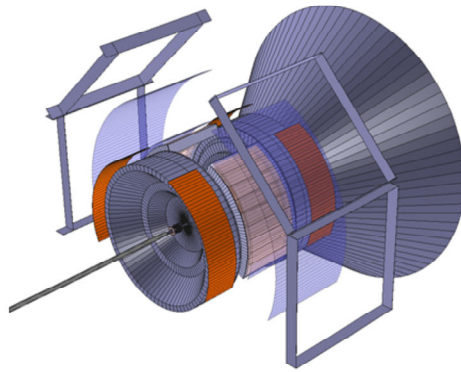

Figures promote audience interest, provide supporting evidence, help explain complex ideas and relationships quickly, and give the audience something to remember

...and they'll look at the figures first, too

31

Use engaging, visually interesting figures to draw listeners into your story and give them something to remember.

Illustrate each of your main points with an engaging image.

“Graphic excellence is that which gives to the viewer the greatest number of ideas in the shortest time with the least ink in the smallest place.”—Edward Tufte

Who can tell me the four reasons to include figures in your talk?

Three reasons?

Two reasons?

Who remembers the image shown on the previous slide?

I rest my case...

32

People remember pictures much longer and better than they remember words.

**Most people will remember your
images better than your words...**

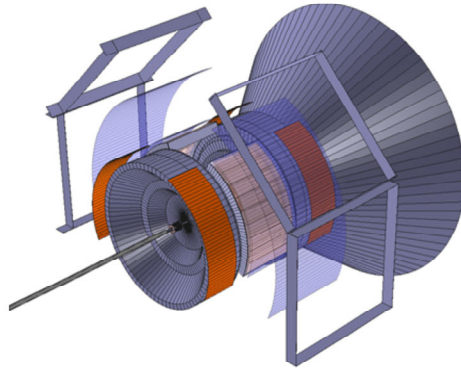

**Figures promote audience
interest, provide supporting
evidence, help explain
complex ideas and
relationships quickly, and
give the audience something
to remember.**

**...and they'll look at the
figures first, too**

33

Let's look at this slide again. If its purpose was to convey the four reasons why speakers should include figures in their talks, the slide was set up from the beginning to fail because of the way the information was presented.

Figures serve four purposes in talks

1. Engage the audience and capture their interest
2. Provide supporting evidence
3. Help explain complex ideas and relationships quickly
4. Give the audience a visual, memorable “hook” to hang your key ideas on

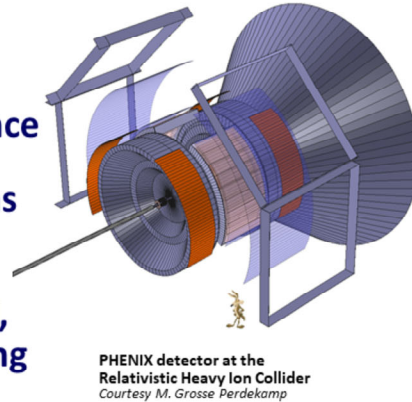

Tip: Add a brief caption to orient the audience immediately—they're going to look at the figure before you explain it—and always add a scale

34

First, change the motivating statement at the top of the slide to emphasize the idea that there are **four** reasons to use figures. In the original slide, the message in the title is “remember the figure,” and the subtitle is “look at the figure first.”

Present the points in a numbered list—easier to process (and remember) that there are four reasons than to sort them out from narrative text presented in paragraph style.

Most Western languages are read from left to right and top to bottom. Place your important points strategically—at the top of the slide and along the left margin. Put your illustrative pictures at the right and lower down on the slide.

Put important ideas in a contrasting color—people look at color first, too.

And always, always, always include a scale for any illustration.

Visual images should inform, explain, or persuade, not merely decorate

Improving the Cooling of Blades and Vanes in Gas Turbine Engines

- To increase efficiency, gas turbine engines have to run at higher power
- Better cooling schemes can dramatically affect the life of blades and vanes in gas turbines



35

While a spectacular and captivating photo (of a vapor cloud forming around an F-18 Super Hornet as it approaches the sound barrier), this image has **nothing** to do with cooling schemes for gas turbine engines. Instead of explaining or amplifying the ideas presented, the photo competes with them.

Anybody going to this talk probably already knows what a jet airplane looks like. All this image does is distract the audience from the information the speaker is trying to convey. Who wants to pay attention to the boring, dense text when they can try to figure out what kind of fighter jet this is and why a vapor cloud is forming around it?

This slide also illustrates a problem with presenting information in bulleted lists. The narrative text all runs together.

Here's how I'd change this slide:

Improved cooling increases operating lifetimes of blades and vans in gas turbine engines

- Higher power = increased efficiency
- Higher power = more heat produced
- Better cooling schemes = increased lifetimes of blades and vanes

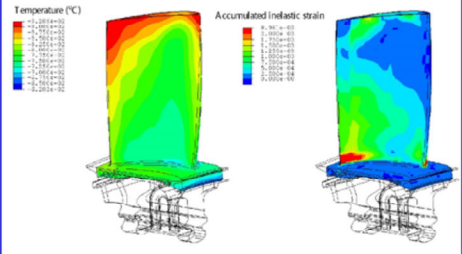

Add a motivating statement to replace the bland "title"
Turn off the bullets for more room
Write short phrases instead of full narrative sentences
Increase the interline spacing for improved readability
Show some data!

36

Here's how to improve this slide:

Change the centered title to a left-justified statement.

Turn off the bullets, "hanging indent" the text, and add extra space between items to make the text easier to read.

Write short phrases, not full narrative sentences, to make the text easier to read.

Change the interline spacing to make the text more compact, which allows more text per vertical inch and more inter-item spacing. On the "Paragraph" section of the ribbon, click on the down arrow to open the dialog box:



Then change the spacing to "Multiple" and type 0.9 in the box.

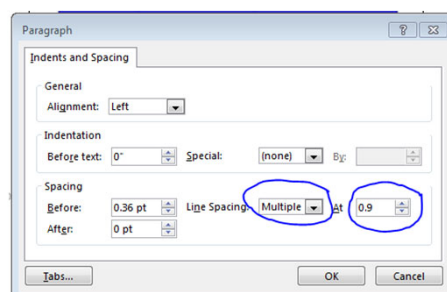

Improving the Cooling of Blades and Vanes in Gas Turbine Engines

- To increase efficiency, gas turbine engines have to run at higher power
- Better cooling schemes can dramatically affect the life of blades and vanes in gas turbines



← **Before**

After →

Improved cooling increases operating lifetimes of blades and vanes in gas turbine engines

- Higher power = increased efficiency
- Higher power = more heat produced
- Better cooling schemes = increased lifetimes of blades and vanes

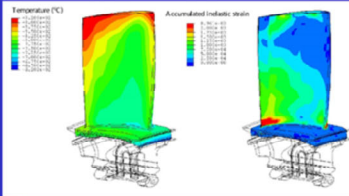

37

Here's the "before" and "after" versions of the slide. Which do you think does a better job of informing, educating, and persuading the audience?

Use manual line breaks so that the text is not interrupted in awkward places

- SPring-8: electron storage ring for synchrotron radiation, 8 GeV
- LEPS = Laser Electron Photon beam @ SPring-8
- Compton back scatter 351 nm Ar (UV) laser photons off electrons
- produces 1.5-2.4 GeV photon beam



Avoid big empty spaces, too

38

To make a line break without starting a new item, press Shift+space bar.

Use the "Arrange" command on the "Drawing" toolbar in PPT to arrange text and figures in layers. Right click on the item you want to arrange and then click on the arrow to the left of the "Send to Back" or "Bring to Front" options to arrange layers.

Extra text boxes don't cost *anything*. You can use more than one on a slide to maximize your slide real estate.

Here's how to do a slide make-over

- SPring-8: electron storage ring for synchrotron radiation, 8 GeV
- LEPS = Laser Electron Photon beam @ SPring-8
- Compton back scatter 351 nm Ar (UV) laser photons off electrons
- produces 1.5-2.4 GeV photon beam



Add an informative title

Show some data!

Position important info strategically

Maximize your slide real estate

Use short captions to orient the viewer immediately 39

Spring-8 "light" is ≈ 1 billion times more brilliant than conventional X-ray sources

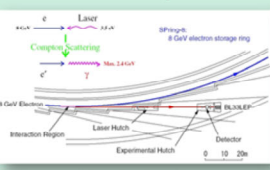

Schematic view of the LEPS beamline and the Compton backscattering process

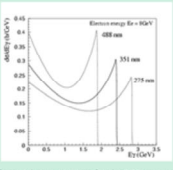

Differential cross sections for the BCS process between 8-GeV electrons and laser photons

Spring-8: Storage ring for 8-GeV synchrotron radiation
Compton back scatters 351-nm Ar (uv) laser off electrons
Produces 1.5-GeV-2.4-GeV photon beam



Here's how I would improve the previous slide.

- Add a motivating statement at the top of the slide.
- Make the obligatory aerial photo of the accelerator smaller and stick it at the lower right of the slide.
- Turn off the bullets and tighten up the prose to reduce the number of lines of text.
- Use the additional space you've freed up to show a cartoon of the physical process, a schematic of the beamline, and the energy spectra of the photons, and put those images at the top of the slide to emphasize them.

If you just *have* to show the mandatory aerial photo of the accelerator, make it smaller, move it off center-stage, and crop to emphasize the ring, not the surrounding countryside. A scale would be really nice, but although I found 48 different aerial photographs of SPring-8 on the Internet, not one showed how big it is. A label superimposed on the photo that shows where LEPS is located on the ring would be a good addition, too.

Some technical-editing changes:

- A hyphen is required between 8 and GeV in the first line, 351 and nm in the second line, and 1.5 and GeV and 2.4 and GeV in the last line of text. In every case, the number is combined with the unit to make an adjective that describes the size of the following noun; you indicate that it's an adjective by hyphenating the two components.
- The abbreviation for "ultraviolet" (and infrared) is always written lower case.
- Provide both lower and upper units for numbers in a range.
- Indicate a range by an en dash, not a hyphen.

Images taken from <http://www.rcnp.osaka-u.ac.jp/Divisions/np1-b/lepsbl.html>.

Use PPT animation to control the audience's attention while you're speaking

Spring-8 "light" is ≈ 1 billion times more brilliant than conventional X-ray sources

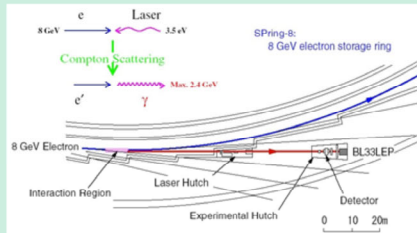

Schematic view of the LEPS beamline and the Compton backscattering process

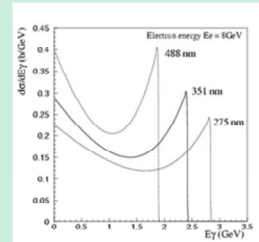

Differential cross sections for the BCS process between 8-GeV electrons and laser photons

**Spring-8: Storage ring for 8-GeV synchrotron radiation
Compton back scatters 351-nm Ar (uv) laser
off electrons
Produces 1.5-GeV–2.4-GeV photon beam**



40

When you present an audience with a complicated slide like this one, they don't know what to look at first and they try to look at everything instead of listening to you. Control their attention by using animations to present bits of information at a time, synchronized with what you are saying.

Using animations requires practice and rehearsal—we've all forgotten about an animation and then were surprised when something popped up when we were expecting that click to bring up the next slide.

Mark up your notes pages to indicate animations so you can keep track of them as you are speaking.

Use PPT animation to control the audience's attention while you're speaking

Spring-8 "light" is ≈ 1 billion times more brilliant than conventional X-ray sources

**Spring-8: Storage ring for 8-GeV synchrotron radiation
Compton back scatters 351-nm Ar (uv) laser
off electrons**

Produces 1.5-GeV–2.4-GeV photon beam



41

Use PPT animation to control the audience's attention while you're speaking

Spring-8 "light" is ≈ 1 billion times more brilliant than conventional X-ray sources

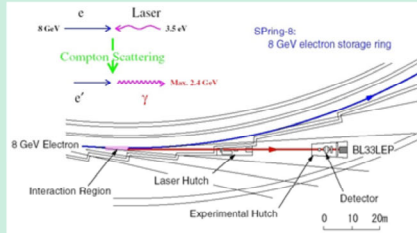

The Compton backscattering process and schematic view of the LEP5 beamline

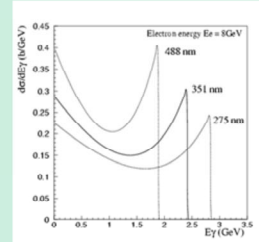



Differential cross sections for the BCS process between 8-GeV electrons and laser photons

Spring-8: Storage ring for 8-GeV synchrotron radiation
Compton back scatters 351-nm Ar (uv) laser off electrons
Produces 1.5-GeV–2.4-GeV photon beam

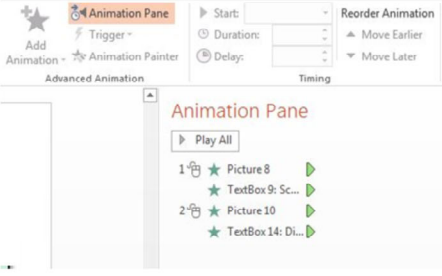

You can “build” slides in one of two ways

Use PPT animation (learning curve)



***Tip: Use the “Insert Duplicate Slide” tool for smooth builds**

Create multiple slides*

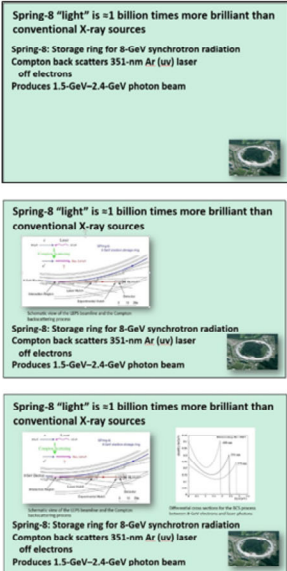

43

The animation tool gives you more control and offers a variety of special effects. However, like anything else, there's a learning curve associated with it, and you'll have to invest time to get good at it.

Creating multiple slides is easier—at least initially—and extra slides don't cost a dime. For best results, do the first, stripped down slide, and then use the “insert duplicate slide” tool to make each subsequent slide. That way, you don't have slight variations in the position of text and figures (which is distracting and annoying) when you switch from one slide to the next.

On the main toolbar in PPT, click on the “Insert” tab.

When the “Insert” ribbon comes up, click on the down arrow on the “New Slide” icon (first one on the far left), and scroll to the bottom of the menu to “Duplicate Selected Slides” and click on it. (I have no idea why MS uses this language; when you click on that item, PPT inserts a duplicate of the slide you are on—you cannot “select” multiple slides. <sigh>)

Never ***ever*** put ***anything*** on a slide
that you do not thoroughly understand



That figure you got from somebody else
and added at the last minute...

44

...will be all the audience asks questions about



**Tip: Don't put anything on a slide that
you don't explicitly talk about, either!**

45

Technology presents its own challenges
Seminar and conference rooms are increasingly being outfitted with LCD monitors instead of fluorescent projector screens

Laser pointers don't work on LCD monitors



Use the built-in PPT laser pointer (awkward)
Add animated arrows to your slide to point out important features

46

You could point out features with your hand, but the monitors are often mounted on the wall across the room, or behind you, where you cannot easily reach them without really distracting the audience.

Don't try to use your laser pointer and then say, "Huh! The laser pointer doesn't work. Wow! Now what do I do? Well, I guess you can see what I mean..."

Use minimal hand gestures



Distracts the audience if you're flapping around

Use a laser pointer, not your arm

An innocuous gesture in your culture may mean something entirely different in another culture



Tip: Avoid laser-pointer acrobatics



47

See http://www.cracked.com/article_16335_7-innocent-gestures-that-can-get-you-killed-overseas.html. The examples are quite true, but the language is a bit too vernacular for this straight-laced Midwesterner. Read at your own risk.—*cme*

If English is not your first language (and even if it is!)...use the simplest word



Tip: Watch for cues from the audience—if they look confused, slow down, repeat, ask a rhetorical question, solicit a question, explain

48

Do not use jargon unless you explain it (What is SPH, anyway?).

Choose the simplest words—imagine that you are giving a talk in English to people who don't speak English as a first or even a second language. In physics, you probably are!

If English is not your first language, do not be embarrassed to ask a native speaker to review your presentation and correct your pronunciation.

Practice speaking slowly and distinctly, whatever your first language is.

Provide a “summary” slide and make it count!

Recap key results

Reiterate principal conclusions

Repeat your contact information

Summary and the future

- › Post-processed CNT fiber could be a material useful in many applications
- › **Joule heating** was applied to induce **cross-linking**
- › Cross-linking was neither confirmed nor denied
- › Tensile strength test results inconclusive
- › **Future plans:**
 - characterize plasma-irradiated fibers with resistance measurements
 - Use pulses of current instead of steady current
 - Strength test more samples

Questions? Contact me!
Thomas Hymel - hymel1@illinois.edu
1/27/2012 10

Tip: Your last slide will probably get the longest exposure, and it will be the first thing people see when they wake up

49

The summary slide lets you reiterate your key points and cues the audience that you will soon be taking questions. Leave it on the screen during the “questions” period—it will help people review what they’ve learned and remind them of questions they want to ask.

Add your contact information at the bottom of the summary slide; people may not remember it from your title slide.

Before you leave for your talk, email an editable copy of your file to yourself, at an address you can get to from the road

Laptops fail

Thumb drives get lost

Files get corrupted

The person who was supposed to load your talk on the seminar room's computer gets sick or forgets

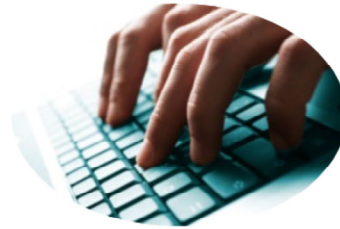

Tip: Print out a hard copy of the "notes" pages and take it along. Note animations on the hard copy.

50

Take along a printed copy of the "notes" pages, too. Use them to rehearse on the plane. Mark where the animations occur.



Arrive ahead of your appointed time. Don't dash in at the last minute, panting and out of breath, in your coat, umbrella, galoshes, backpack, juggling a bag of exhibit-hall geegaws.

Check everything before your talk.

Check the projector:

Make sure you know how to turn it on.

See that it is plugged in and accepting the signal from your laptop.

Adjust the focus.

Check microphones, pointer, other tools.

If a clip-on mike is used, make sure it is fastened securely, check the volume, and then leave it alone.

Arrange your slides, notes, and other materials so you can reach everything without fumbling.

If the battery on your laptop dies or the bulb burns out on the LCD projector, can you still give your talk? (Here's where the hard copy of the notes pages is essential.)

Do not expect the conference organizers to take care of all your needs if you do not tell them what they are ahead of time. Did you request an overhead projector? Slide projector? An adapter for your Mac?

TURN OFF YOUR CELL PHONE!!

A word about appropriate dress...



Tip: Wear comfortable clothes that present a neat, professional appearance (and to which you can attach a lapel microphone and power supply)

52

The day of your talk is not the day to try out your new thong underwear or strapless underwire bra.

Wear comfortable shoes.

Wear a shirt or blouse that you can clip a portable microphone to, so that it is positioned about 5–6 in. below your mouth. Turtlenecks and tee shirts should be avoided, because there's no good place to clip the microphone where it won't slip.

Wear slacks or a skirt with a waistband or pockets for the microphone's power supply.

Handling questions is an essential part of giving a talk

Don't be nervous—think of it as a discussion among colleagues

Always repeat the question

What if you don't know the answer?

If the questioner disagrees, don't argue

***Never* insult the questioner**

If the question is off topic, deflect



53

Always repeat the question (summarize or paraphrase it) before you plunge ahead with your answer. Not everyone may have heard it, and repeating it not only allows the questioner to clarify if you've misunderstood, it also gives you a few precious seconds to think about your answer.

If you don't know the answer, don't bluff! Simply say, "That's an excellent question. We haven't looked at that." or "I'm not sure; I'll have to think about that." It's okay not to know the answer; it's not okay to make something up on the fly.

If the questioner disagrees, or wanders too far off-topic, you can always say, "Thank you for sharing these interesting ideas. Let's talk about this further after the session..."

Resist the temptation to set a questioner straight, particularly if the questioner is ignorant, deluded, or obnoxious. You'll just look bad. A talk is a forum to share your ideas; it's not a point-scoring debate.

To recap:

Determine your goal(s) for the talk and analyze your audience

Decide on the major points you want to make

Design your talk to make these points clearly, concisely, and memorably

Select colors and images judiciously—pay attention to slide aesthetics

Rehearse and revise (shorten!**)**

$$p = \frac{t}{8}$$



cmelliot@illinois.edu

<http://physics.illinois.edu/people/Celia/>

54

Notes and Questions: