

# Superconducting qubits and quantum computers

IBM Q

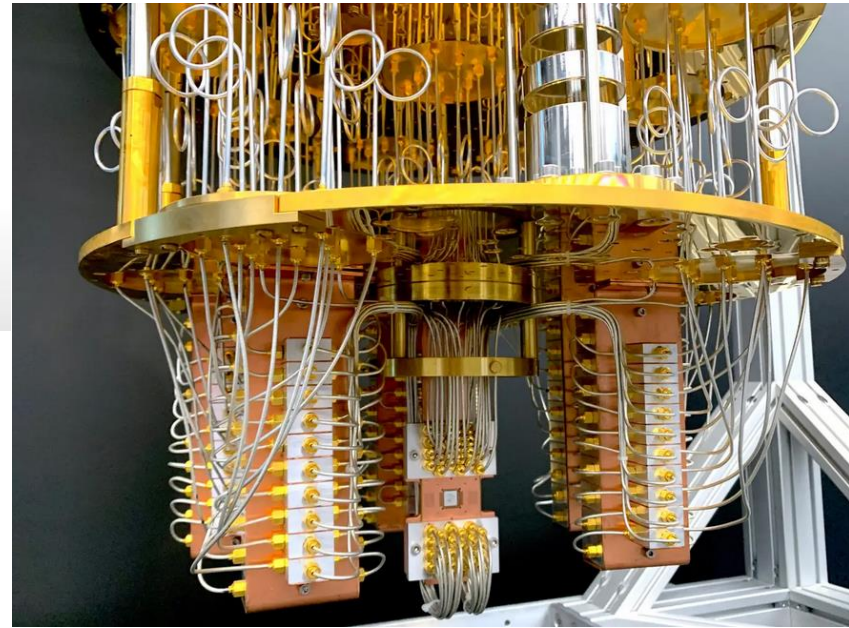

nature

NEWS | 04 December 2023

## IBM releases first-ever 1,000-qubit quantum chip

The company announces its latest huge chip – but will now focus on developing smaller chips with a fresh approach to ‘error correction’.

<https://www.popsci.com/technology/in-photos-journey-to-the-center-of-a-quantum-computer/>

# Superconducting quantum computing

Superconducting quantum computing is a branch of solid state quantum computing that implements superconducting electronic circuits using superconducting qubits as artificial atoms, exhibiting discrete energy states. Research in superconducting quantum computing is conducted by companies such as Google, IBM, IMEC, BBN Technologies, Rigetti, Intel and others. Many recently developed QPUs (quantum processing units, or quantum chips) utilize superconducting architecture.

As of May 2016, up to 9 fully controllable qubits are demonstrated in the 1D array,[1] and up to 16 in 2D architecture.[2] In October 2019, the Martinis group, partnered with Google, published an article demonstrating quantum supremacy, using a chip composed of 53 superconducting qubits [3].

[1] <https://www.nature.com/articles/nature14270>

[2] <https://newsroom.ibm.com/>

[3] <https://www.nature.com/articles/s41586-019-1666-5>

# Qubits

A qubit (short for quantum bit) is **the basic unit of information in quantum computing and counterpart to the bit (binary digit) in classical computing.**

A qubit plays a similar role as a bit, in terms of storing information, but it behaves much differently because it can be prepared in a superposition of two distinct quantum states.

The main difference between a classical digital bit and a quantum qubit is that a classical bit, at any given moment in time, can exist in just one state: Either it is in the logical “zero” state, or it is in logical “one” state. Yet, a qubit, according to the superposition principle in quantum mechanics, can be in the state “zero” (use notation:  $|0\rangle$ ) and the state “one” (use notation:  $|1\rangle$ ) at the same moment in time. For example, the state of the qubit can be  $|zero\rangle+|one\rangle$  or it could be  $|zero\rangle-|one\rangle$ , or it can even be  $|zero\rangle-i*|one\rangle$ , or any other linear combination of the two basis states.

# Qubits

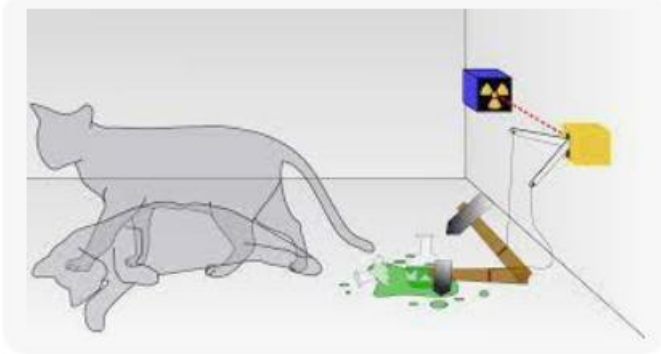

Wikipedia

Schrödinger's cat - Wikipedia

A superconducting qubit is a macroscopic quantum device, in the sense that it is a macroscopic device which acts as a quantum system, according to the law of quantum mechanics.

Superconducting qubits are “artificial atoms”. Each qubit can exist in two distinct states: the ground state with energy  $E_0$  and the excited state with energy  $E_1$ . **The excitation energy** of the qubit is  $\Delta E = E_1 - E_0$ .

It is always possible to choose a convenient reference energy, so we can assume  $E_0 = 0$ . In this case the phase of the wavefunction in the ground state will be constant in time. The phase in the excited state will evolve in time as  $\phi = -E_1 t / \hbar$ .

# Basic examples of natural qubits



single spin-1/2

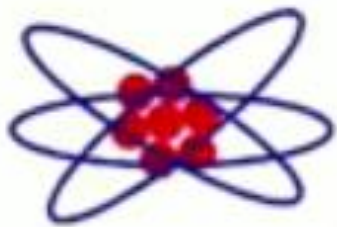

single atom

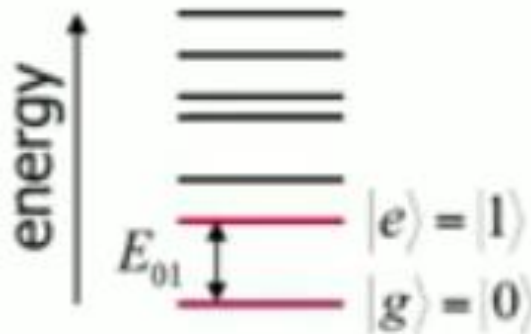

Quantum state:

$$|\psi\rangle = A^*|0\rangle + B^*|1\rangle$$

Normalization condition:

$$|A|^2 + |B|^2 = 1$$

A and B are complex numbers.

$|A|^2$  is the probability to detect state “0”

$|B|^2$  is the probability to detect state “1”

# Math for qubits

Qubit can be compared to a vector in two-dimensional space. The components of the vector are complex numbers,  $a$  and  $b$ , as is illustrated in the example below.

$$\begin{bmatrix} 1 \\ 0 \end{bmatrix} = |0\rangle$$

$$\begin{bmatrix} 0 \\ 1 \end{bmatrix} = |1\rangle$$

$$|q\rangle = a|0\rangle + b|1\rangle = a \begin{bmatrix} 1 \\ 0 \end{bmatrix} + b \begin{bmatrix} 0 \\ 1 \end{bmatrix} = \begin{bmatrix} a \\ b \end{bmatrix}$$

$$\text{Qubit state notation: } |q\rangle = \begin{bmatrix} a \\ b \end{bmatrix}$$

$$\text{Normalization: } |a|^2 + |b|^2 = 1$$

Dirac notations are shown on the right. They are called “bra” and “ket” symbols representing a quantum states.

$$\langle 0|0\rangle = 1; \quad \langle 1|1\rangle = 1;$$

$$\langle q|q\rangle = 1$$

Probability of state zero is  $|a|^2$

Probability of state one is  $|b|^2$

# Logic gates acting on qubits

In quantum computing and specifically the quantum circuit model of computation, a quantum logic gate (or simply quantum gate) is a basic quantum circuit operating on a small number of qubits. In some sense it can be understood as a Hamiltonian operator acting on qubits and evolving them from the initial quantum state to the final quantum state in a desired manner. Quantum gates are the building blocks of quantum circuits, like classical logic gates are for conventional digital circuits.

Before we discuss quantum gates let us review classical logic gates.

# Classical (Boolean) logic gates

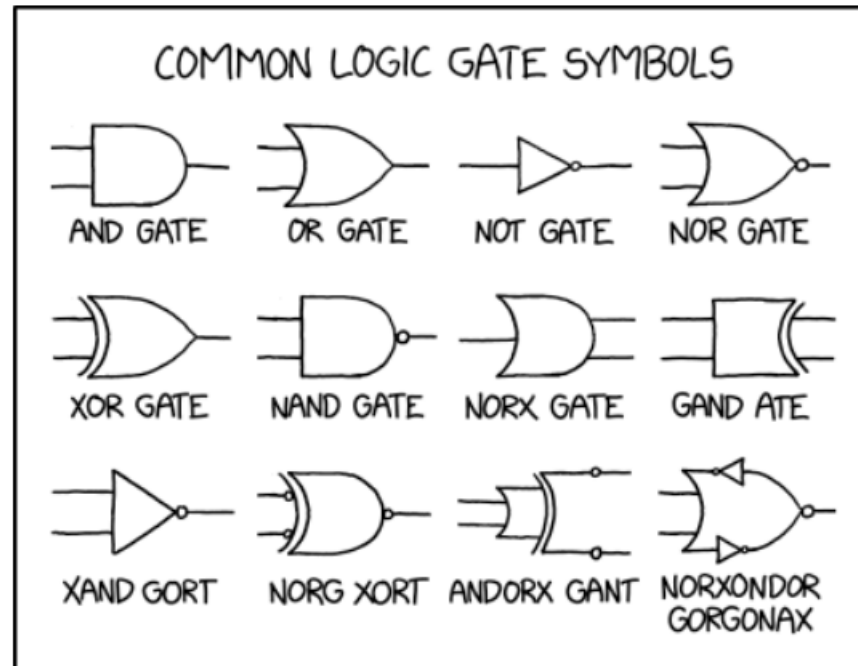

[https://www.explainxkcd.com/wiki/index.php/2497:\\_Logic\\_Gates](https://www.explainxkcd.com/wiki/index.php/2497:_Logic_Gates)



## Example: AND gate in Boolean logic

$$(i) A \cdot 0 = 0$$

$$(ii) A \cdot 1 = A$$

$$(iii) A \cdot A = A$$

$$(iv) A \cdot \bar{A} = 0$$

If any of the inputs is zero,  
then the result of the AND  
operation is zero.

If both inputs are “one”  
then the output is “one”.



A	B	Q
0	0	0
0	1	0
1	0	0
1	1	1

**AND**

<https://homepages.inf.ed.ac.uk/rbf/HIPR2/logic.htm>

[https://www.tutorialspoint.com/computer\\_logical\\_organization/boolean\\_algebra.htm](https://www.tutorialspoint.com/computer_logical_organization/boolean_algebra.htm)

# What is a classical digital computer?

Classical digital computer is a network of various logic gates

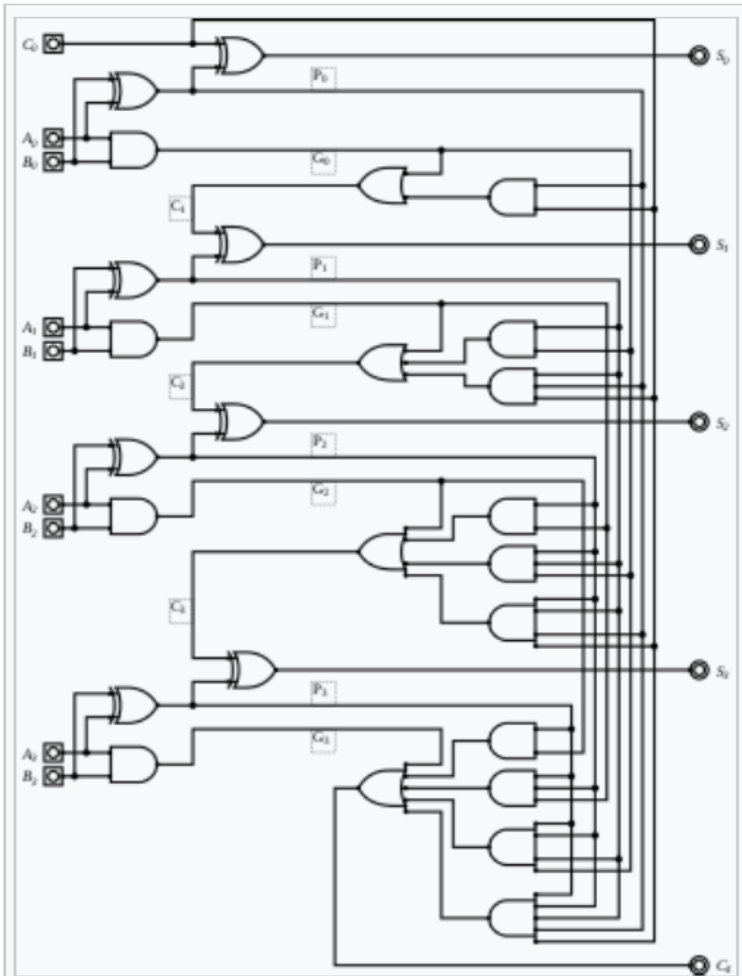

A logic circuit diagram for a 4-bit **carry lookahead binary adder** design using only the **AND**, **OR**, and **XOR** logic gates.

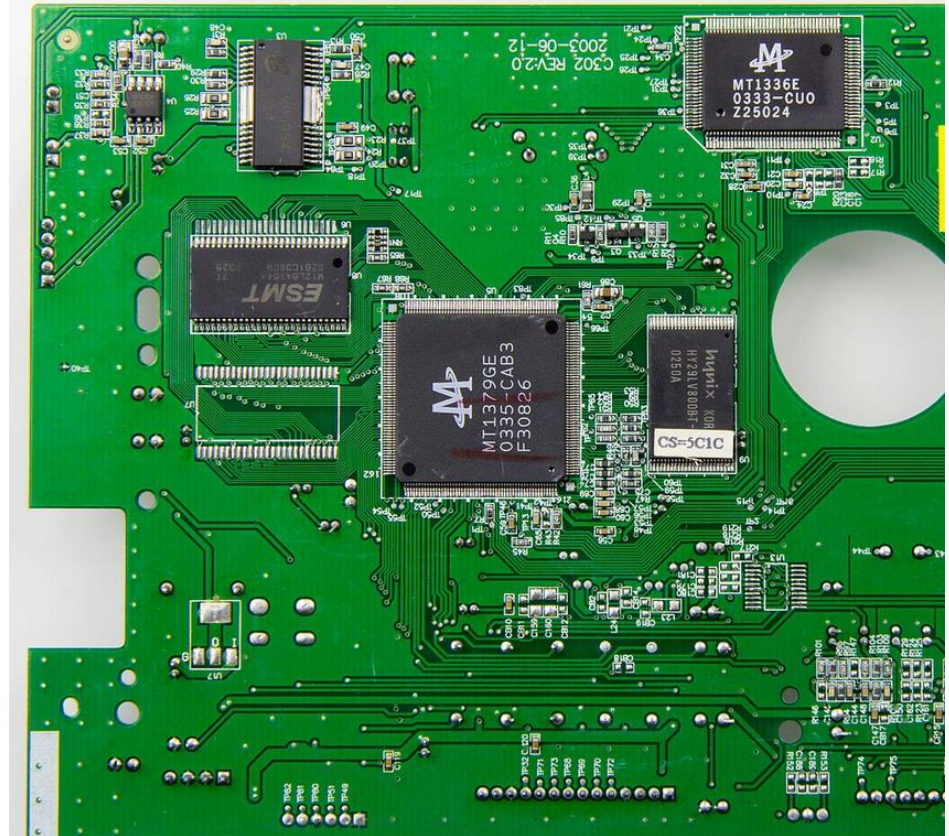

[https://en.wikipedia.org/wiki/Logic\\_gate](https://en.wikipedia.org/wiki/Logic_gate)

[https://en.wikipedia.org/wiki/Printed\\_circuit\\_board#/media/File:SEG\\_DVD\\_430\\_-\\_Printed\\_circuit\\_board-4276.jpg](https://en.wikipedia.org/wiki/Printed_circuit_board#/media/File:SEG_DVD_430_-_Printed_circuit_board-4276.jpg)

# Quantum gates

In quantum computing and specifically the quantum circuit model of computation, a quantum logic gate (or simply quantum gate) is a basic quantum circuit operating on a small number of qubits. They are the building blocks of quantum circuits, like classical logic gates are for conventional digital circuits.

**We consider some one-qubit and some two-qubit gates on the next slide**

# Quantum gates transform quantum states

Gate	Symbol	Matrix
Pauli-X (NOT)		$\begin{pmatrix} 0 & 1 \\ 1 & 0 \end{pmatrix}$
Pauli-Y		$\begin{pmatrix} 0 & -i \\ i & 0 \end{pmatrix}$
Pauli-Z (Phase flip)		$\begin{pmatrix} 1 & 0 \\ 0 & -1 \end{pmatrix}$
S		$\begin{pmatrix} 1 & 0 \\ 0 & i \end{pmatrix}$
T		$\begin{pmatrix} 1 & 0 \\ 0 & e^{i\pi/4} \end{pmatrix}$
Hadamard		$\frac{1}{\sqrt{2}} \begin{pmatrix} 1 & 1 \\ 1 & -1 \end{pmatrix}$
Rotation Z		$\begin{pmatrix} e^{-i\theta/2} & 0 \\ 0 & e^{i\theta/2} \end{pmatrix}$
Rotation Y		$\begin{pmatrix} \cos(\frac{\theta}{2}) & -\sin(\frac{\theta}{2}) \\ \sin(\frac{\theta}{2}) & \cos(\frac{\theta}{2}) \end{pmatrix}$
Rotation X		$\begin{pmatrix} \cos(\frac{\theta}{2}) & -i\sin(\frac{\theta}{2}) \\ i\sin(\frac{\theta}{2}) & \cos(\frac{\theta}{2}) \end{pmatrix}$
CNOT		$\begin{pmatrix} 1 & 0 & 0 & 0 \\ 0 & 1 & 0 & 0 \\ 0 & 0 & 0 & 1 \\ 0 & 0 & 1 & 0 \end{pmatrix}$
Swap		$\begin{pmatrix} 1 & 0 & 0 & 0 \\ 0 & 0 & 1 & 0 \\ 0 & 1 & 0 & 0 \\ 0 & 0 & 0 & 1 \end{pmatrix}$

Example: CNOT

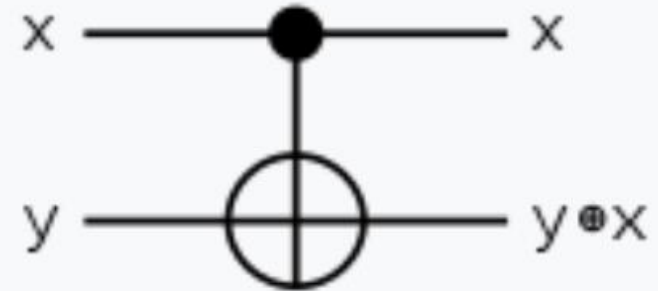

input		output	
x	y	x	y+x
0⟩	0⟩	0⟩	0⟩
0⟩	1⟩	0⟩	1⟩
1⟩	0⟩	1⟩	1⟩
1⟩	1⟩	1⟩	0⟩

# Single qubit quantum gate example: Hadamard

Applying the H gate to  $|0\rangle$  results in:

$$H|0\rangle = \begin{pmatrix} \frac{1}{\sqrt{2}} & \frac{1}{\sqrt{2}} \\ \frac{1}{\sqrt{2}} & -\frac{1}{\sqrt{2}} \end{pmatrix} \begin{pmatrix} 1 \\ 0 \end{pmatrix} = \begin{pmatrix} \frac{1}{\sqrt{2}} \\ \frac{1}{\sqrt{2}} \end{pmatrix} = \frac{|0\rangle + |1\rangle}{\sqrt{2}} = |+\rangle$$

While Hadamard gate is defined as

$$H = \frac{1}{\sqrt{2}} \begin{pmatrix} 1 & 1 \\ 1 & -1 \end{pmatrix},$$

$y$ -rotation by  $\pi/2$  leads to gate

$$Ry(\pi/2) = \frac{1}{\sqrt{2}} \begin{pmatrix} 1 & -1 \\ 1 & 1 \end{pmatrix}$$

# Sphere of all possible quantum states: Poincare-Bloch sphere of quantum states

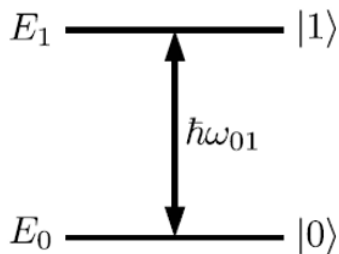
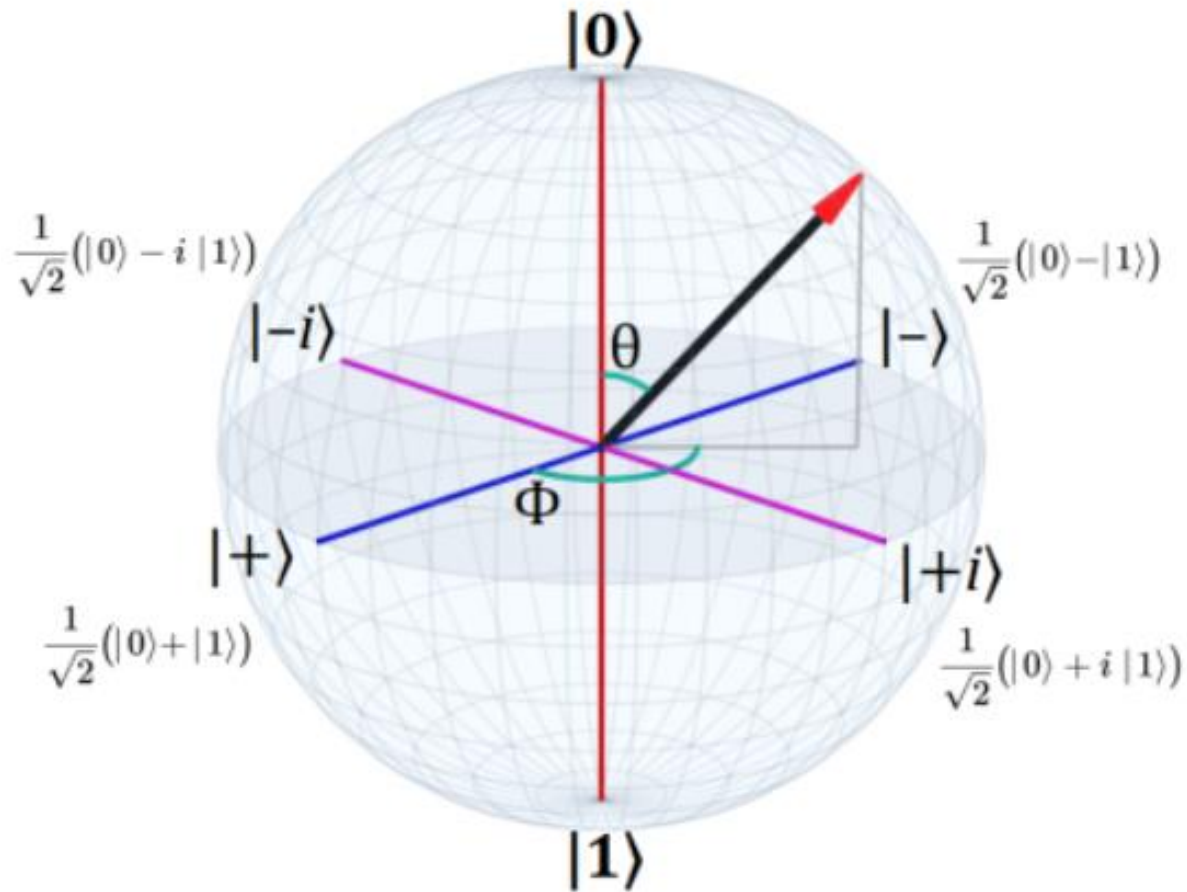

<https://logosconcarne.com/2021/03/15/qm-101-bloch-sphere/>

# DiVincenzo's criteria

According to DiVincenzo's criteria, constructing a quantum computer requires that the experimental setup meet seven conditions. The first five are necessary for quantum computation:

1. A scalable physical system with well-characterized qubit
2. The ability to initialize the state of the qubits to a simple fiducial state
3. Long relevant decoherence times
4. A "universal" set of quantum gates
5. A qubit-specific measurement capability

The remaining two are necessary for quantum communication:

1. The ability to interconvert stationary and flying qubits (Transduction problem)
2. The ability to faithfully transmit flying qubits between specified locations.

# Realization of quantum gates using superconductors

A qubit is a generalization of a bit (a system with two possible states) capable of occupying a **quantum superposition** of both states. A **quantum gate**, on the other hand, is a generalization of a logic gate describing the transformation of one or more qubits once a gate is applied given their initial state. Physical implementation of qubits and gates is challenging for the same reason that **quantum phenomena are difficult to observe in everyday life** given the minute scale on which they occur. One approach to achieving quantum computers is by **implementing superconductors whereby quantum effects are macroscopically observable**, though at the price of extremely low operation temperatures.



# Harmonic oscillator



$$H = KE + PE = T + V$$

$$H = \frac{1}{2}mv^2 + \frac{1}{2}kx^2$$

$$= \frac{1}{2m} m^2 \dot{x}^2 + \frac{1}{2} kx^2$$

$$= \frac{1}{2m} p^2 + \frac{1}{2} kx^2$$

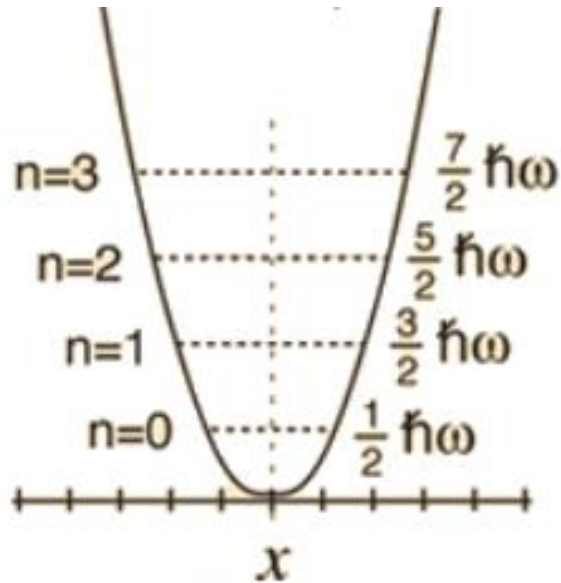

$$E_n = \left(n + \frac{1}{2}\right) \hbar \omega$$

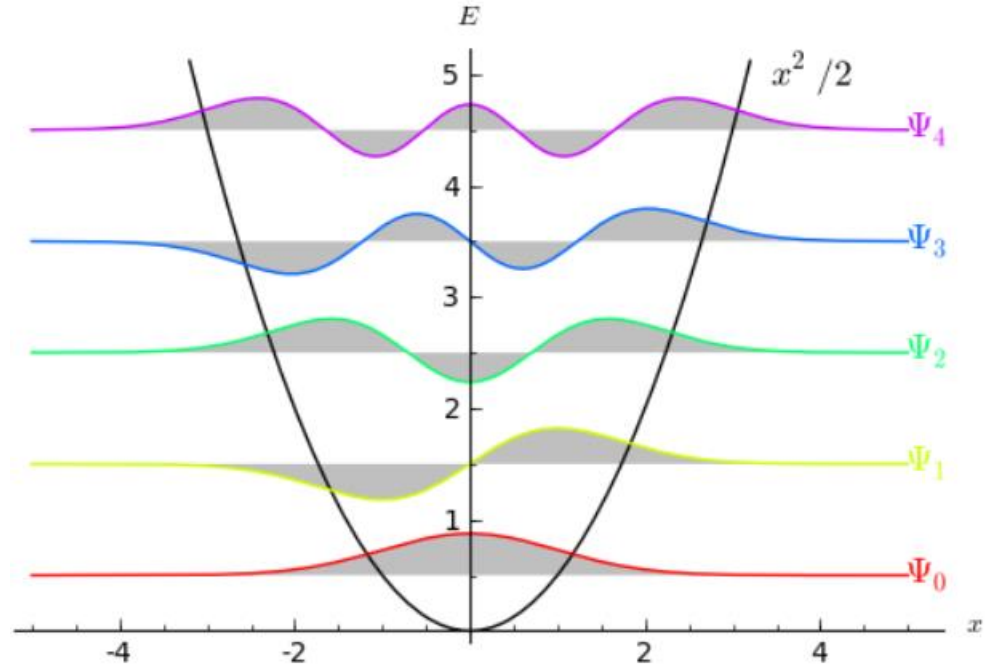

# Quantum description of LC-circuits

## The quantized $LC$ oscillator

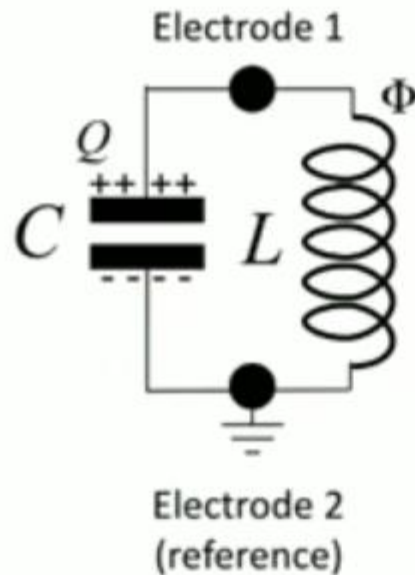

Hamiltonian:

$$\hat{H}_{LC} = \frac{\hat{Q}^2}{2C} + \frac{\hat{\Phi}^2}{2L}$$

Capacitive term      Inductive term

Canonically conjugate variables:

$\hat{\Phi}$  = Flux through the inductor.

$\hat{Q}$  = Charge on capacitor plate.

$$[\hat{\Phi}, \hat{Q}] = i\hbar$$

# Schematic of so-Called “Transmon Qubit” – one of the most reliable qubits

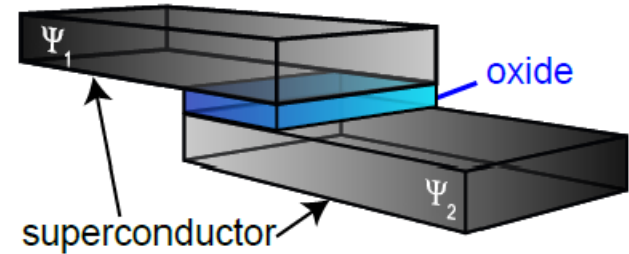
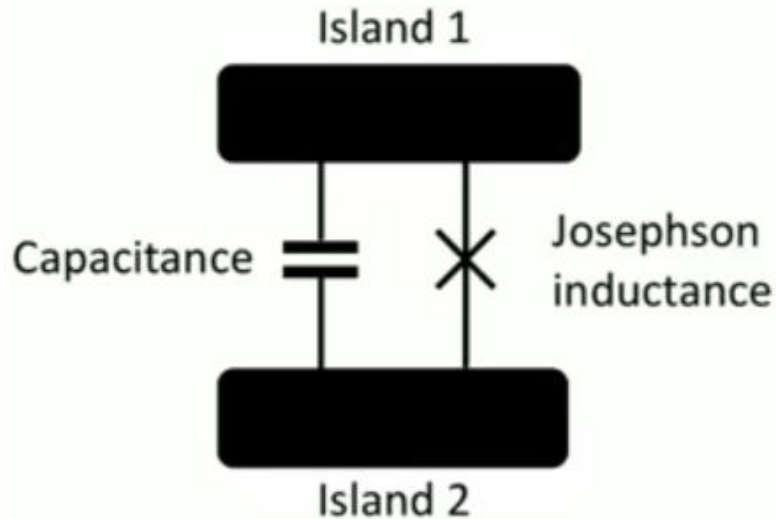

Figure 2.4: Sketch of a Josephson junction.

$$E_J = \frac{\Phi_0 I_c}{2\pi} (1 - \cos \phi_J)$$

$$E_c = e^2 / 2C$$

Theory of transmons: J. Koch et al., Phys. Rev. A **76**, 042319 (2007).

# Schematic of so-Called “Transmon Qubit” – one of the most reliable qubits

$$\hat{H}_{\text{tr}} = 4E_c \hat{n}^2 - E_J \cos \hat{\phi},$$

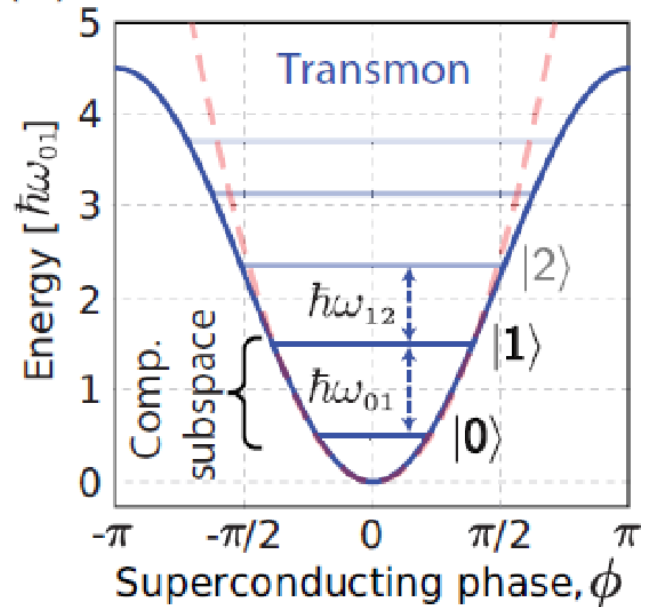
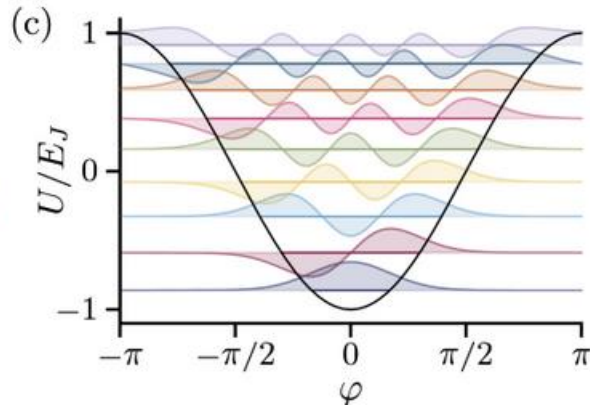
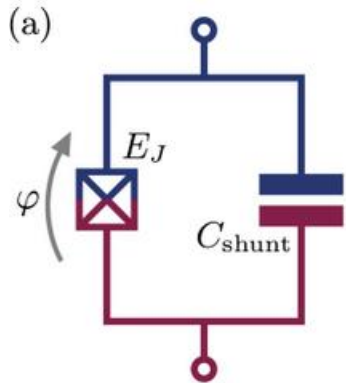

Theory of transmons: J. Koch et al., Phys. Rev. A **76**, 042319 (2007).

# Excitation energy of qubits

Superconducting qubits are “artificial atoms”. Each qubit can exist in two distinct states: the ground state with energy  $E_0$  and the excited state with energy  $E_1$ . **The excitation energy** of the qubit is  $\Delta E = E_1 - E_0$ .

A transmon superconducting qubit is made of a capacitor,  $C$ , and a nonlinear inductor, with inductance  $L$ . In this case the oscillation frequency is  $\omega = (1/LC)^{1/2}$ . **Then the excitation energy is given by the Planck's formula:**  
 $\Delta E = \hbar\omega = \hbar(1/LC)^{1/2}$ .

Finally, if the nonlinear inductance is given by a Josephson junction then the inductance is  $L = \Phi_0 / (2\pi I_c)$ .

Here  $\Phi_0 = h/(2e) = 2 \times 10^{-15}$  Wb is the magnetic flux quantum.

# Non-harmonicity allows controlled evolution of the qubit between the ground state and the first excited state

## Transmon energy spectrum

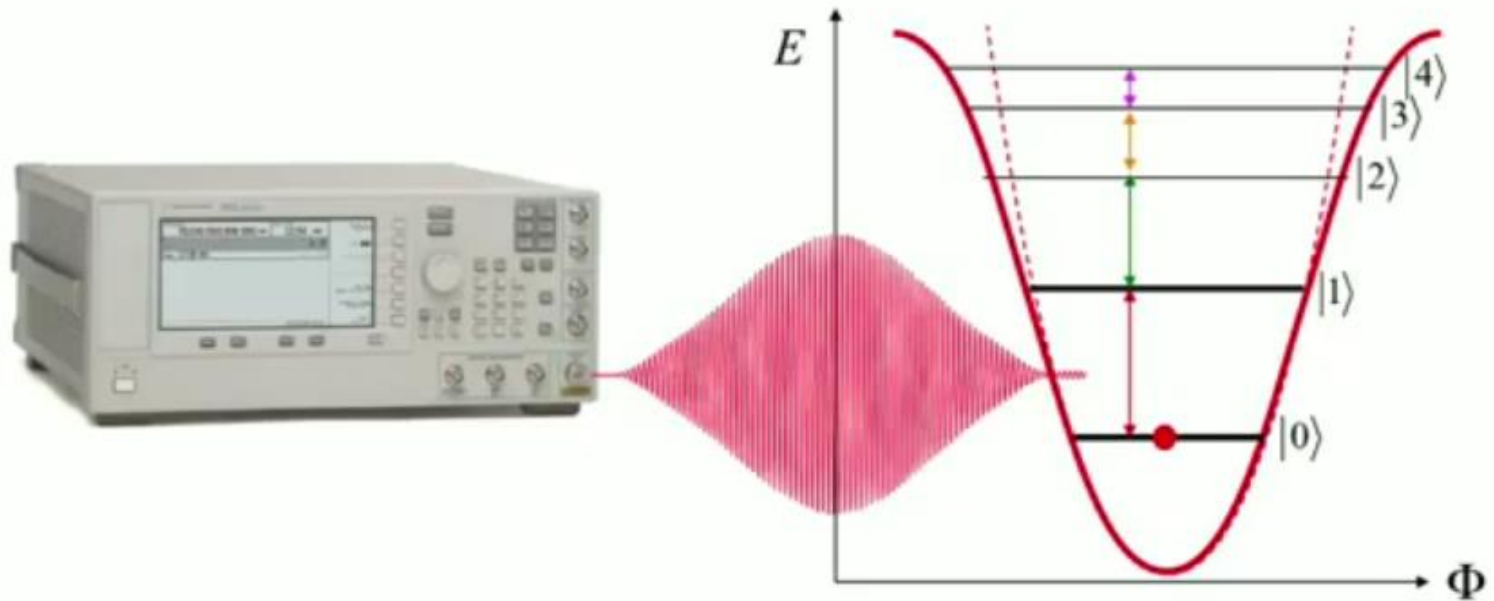

Microwave radiation is used to evolve the qubit from the ground state to the excited state.

# Transmon Qubit inserted into coplanar waveguide resonator

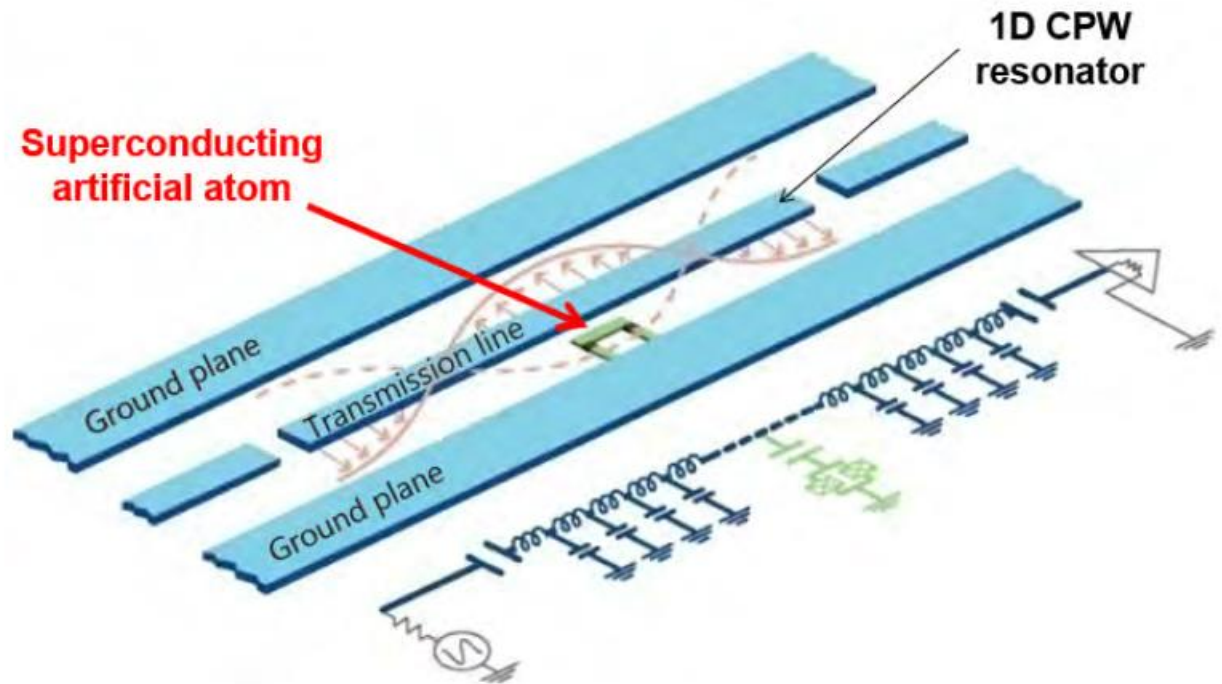
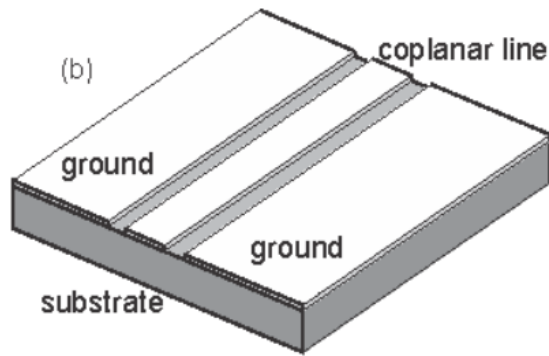

# Principle of the qubit measurement: dispersive shift

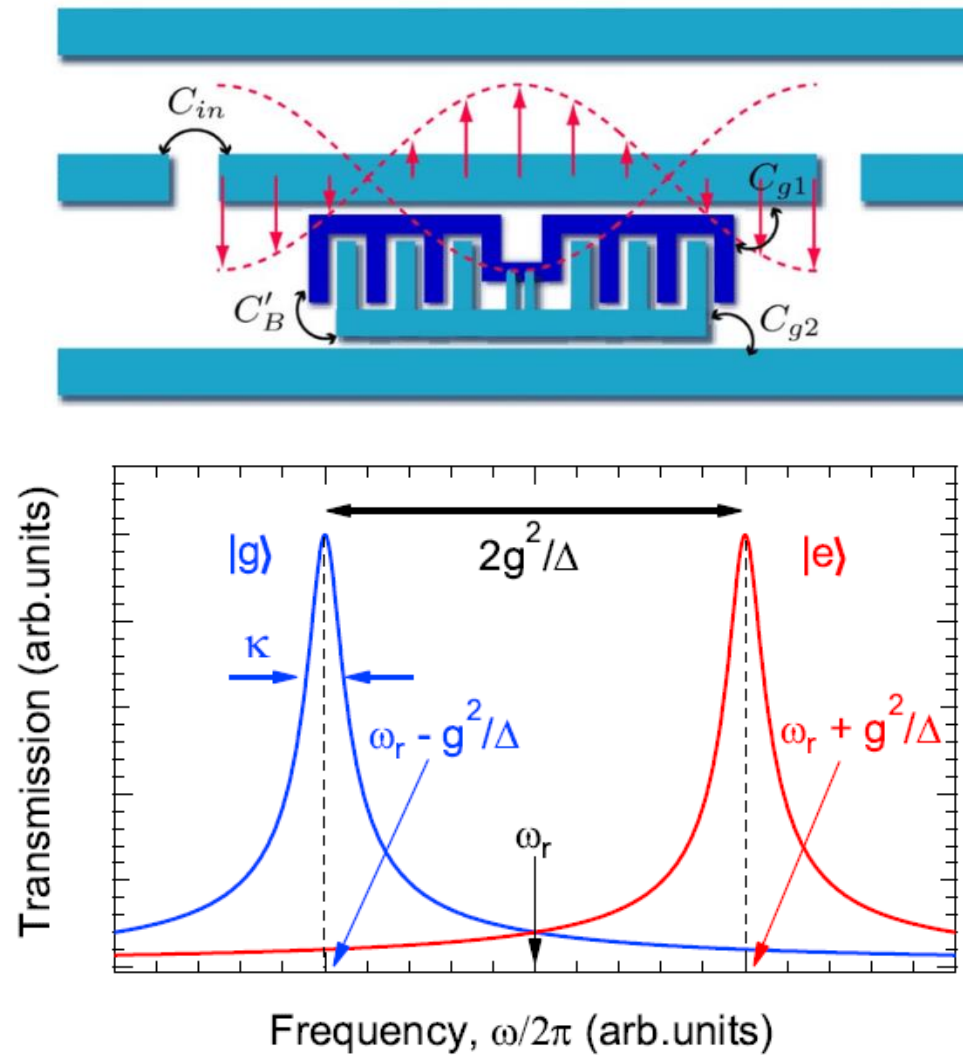

Transmission versus frequency for dispersive measurement.  $\omega_r$  denotes the resonant frequency without the dispersive shift. Depending on the qubit state, the cavity frequency is pulled by  $\pm g^2/\Delta$ .



Setup to measure  
superconducting  
qubits

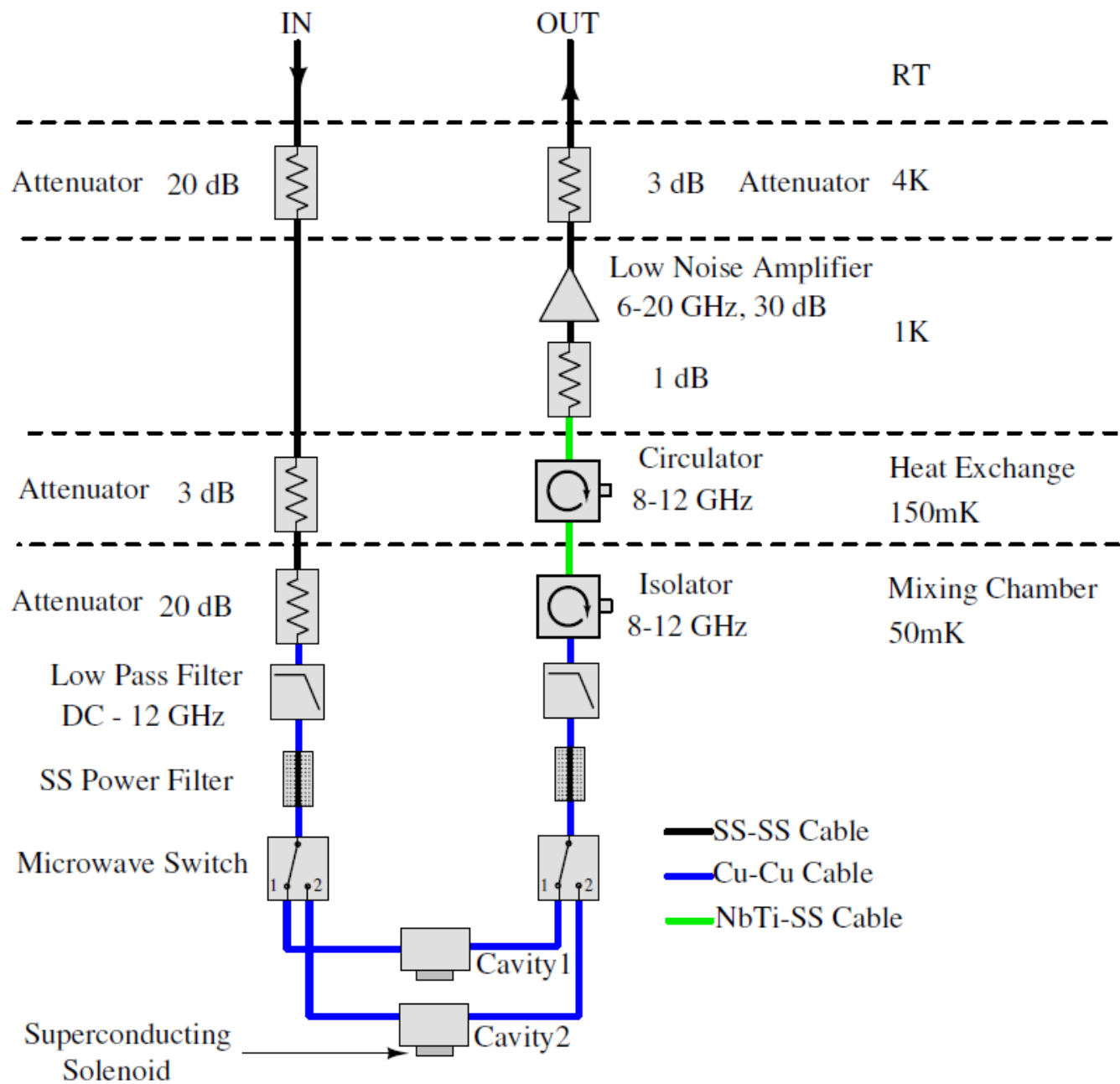

# Example: Meissneron Qubit measured in 3D Cu cavity

The qubit is measured in 3D Cu microwave cavity

Vortices (i.e., their cores)

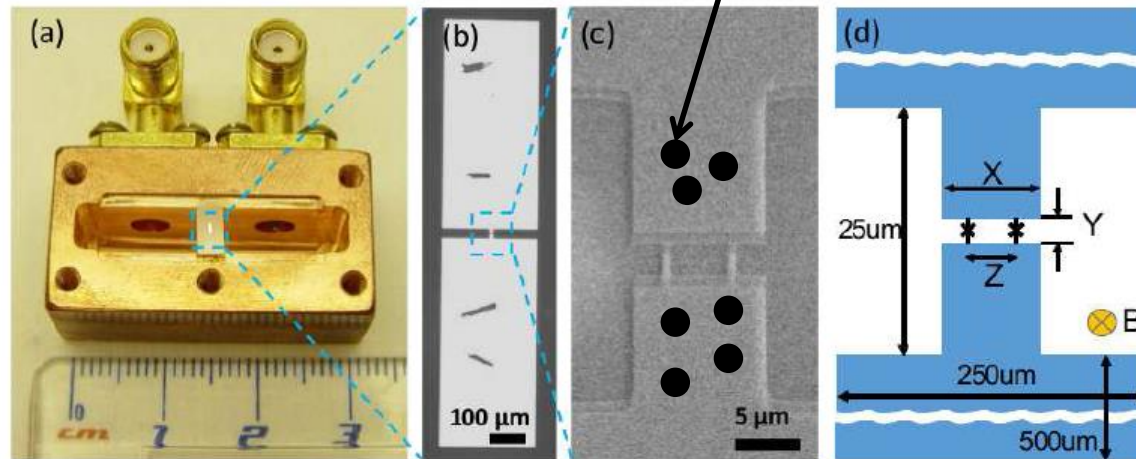

J. Ku, Z. Yoscovits, A. Levchenko, J. Eckstein, and A. Bezryadin,  
Decoherence and radiation-free relaxation in Meissner transmon qubit coupled to Abrikosov vortices,  
*Physical Review B* **94**, 165128(1-14) (2016).

## Effect of vortices on the qubit relaxation and decoherence

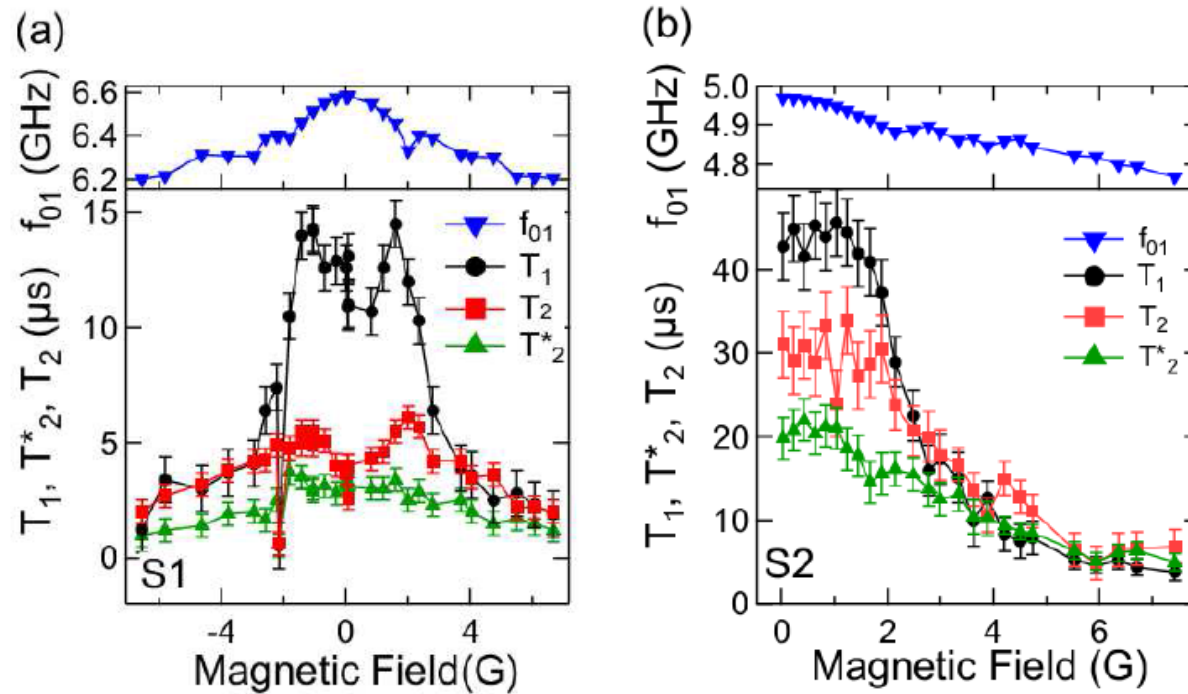
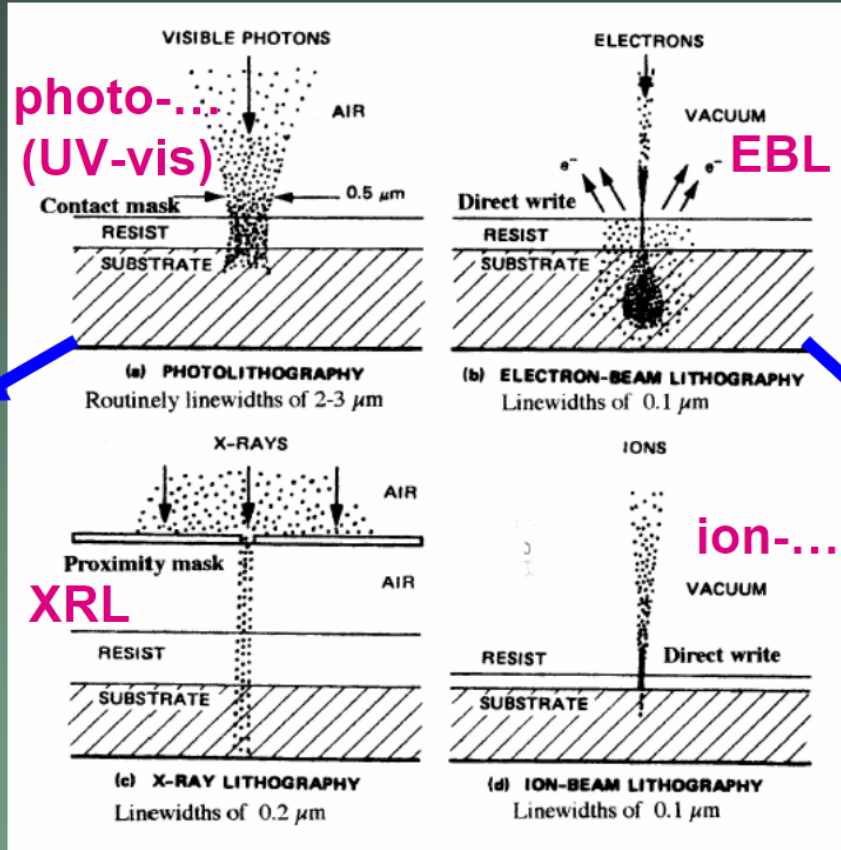

FIG. 5: (Color online) The qubit frequency and timescales were measured at the sweet spots for the S1(a) and S2(b).

# Types of conventional lithography

$\lambda = 0.2-0.4 \mu\text{m}$

photo-...  
(UV-vis)



$$\lambda = h / p$$

	$\lambda(E)$ , [nm,eV]
$\gamma$	$1240 / E$
$e$	$1.23 / \sqrt{E}$

(30 nm res)

EUV  
 $\lambda = 40-5 \text{ nm}$   
(Intel)

XRL

ion-...

SCALPEL  
(Lucent Tech)  
• 2 membrane mask (hi and low e diffusion)  
• scaled down

(20 nm res)

(10 nm res,  
Ta mask)

# Fabrication of qubits: Electron Beam Lithography

**RAITH**  
NANOFABRICATION

eLINE Plus

Discover  
Nanoengineering be-  
yond Electron Beam  
Lithography



The narrowest lines that can be patterned by [Raith](#) eLINE electron beam lithography system in HSQ resist on a standard SiO<sub>2</sub>/Si substrate is ~7nm (left). (right) ~ 11 nm wide metallic line patterned by an e-beam system in 200 nm thick PMMA resist. The line consists of 3 nm of chromium and 10 nm of gold. The scale bar is the same in both images.

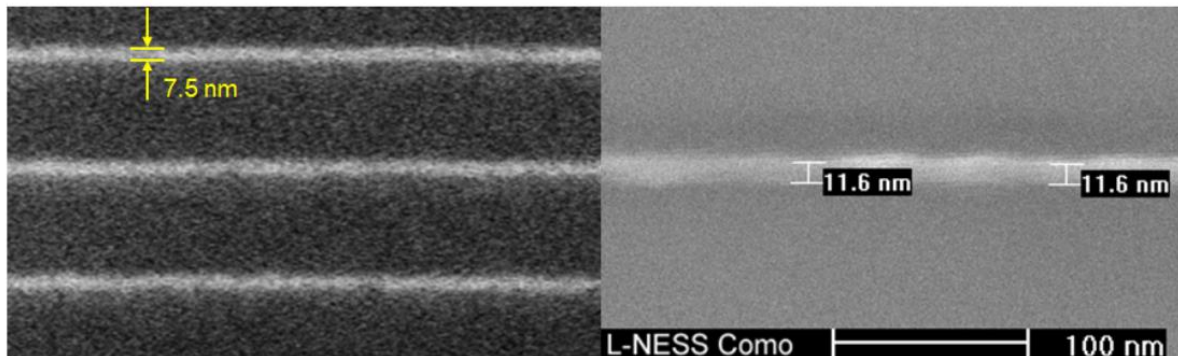

[L-NESS: Electron beam lithography \(polimi.it\)](http://polimi.it)