

Fundamental Symmetry and Neutrino Physics

Liang Yang
Physics 403

April 12, 2022

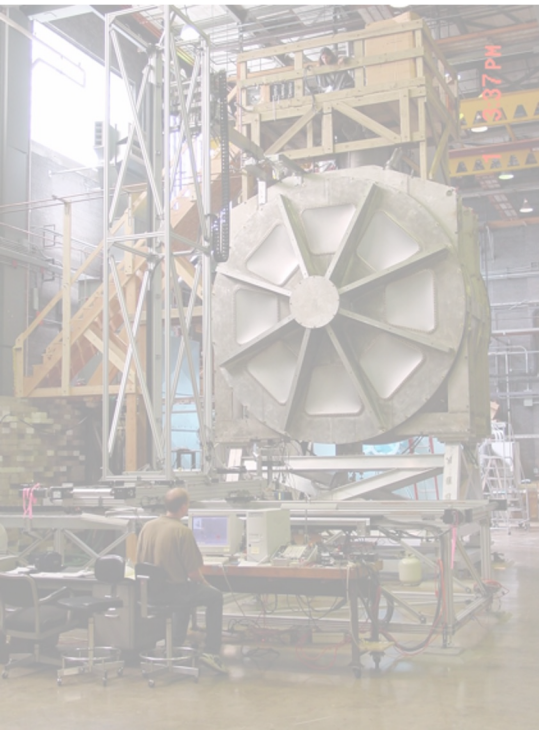

Do we understand the Universe we live in?

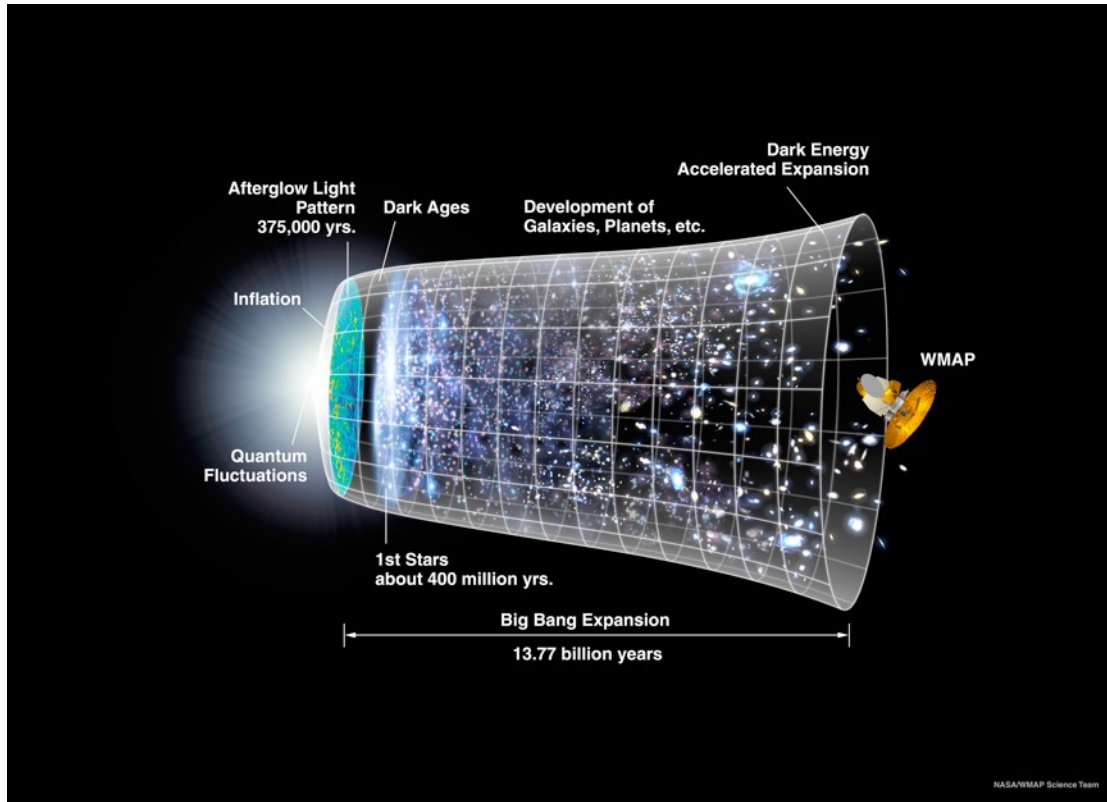

Standard Cosmological Model

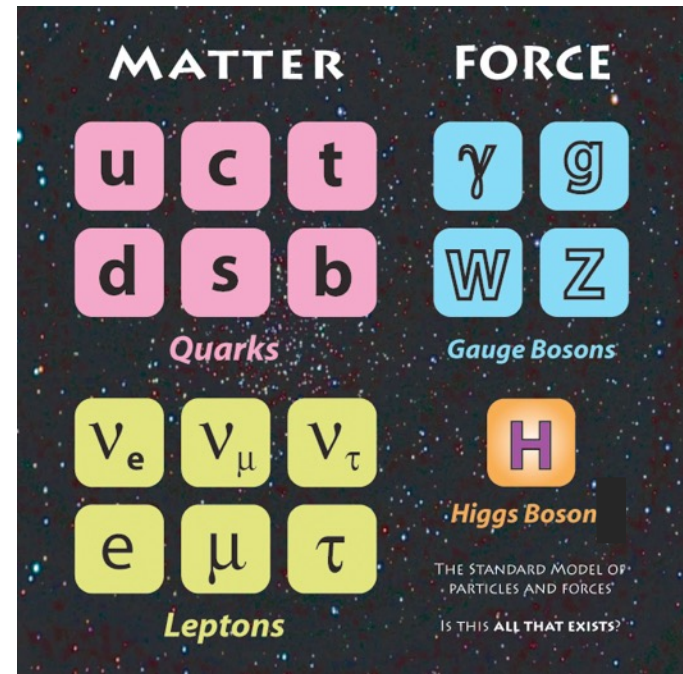

Standard Model of Particle Physics

Standard Models are incomplete...

- What's the origin of matter – antimatter asymmetry in today's Universe?
- What is dark matter or dark energy?
- What is the nature of gravity?
- Can all forces in nature be unified?

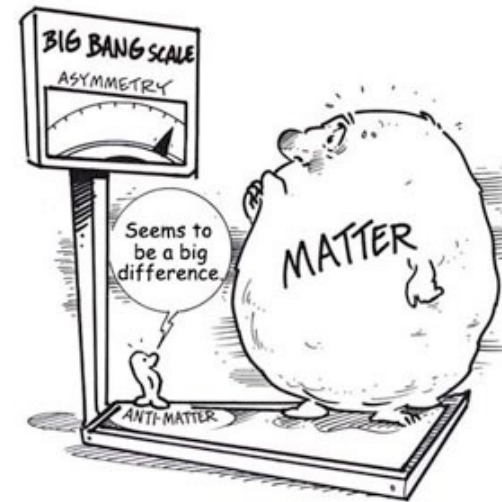

Matter-Antimatter Asymmetry



Dark Matter

In Search of “New” Standard Model

■ LHC: direct search for new particles

- ◆ Discovery of Higgs!
- ◆ Hints of New Physics?

■ Precision measurements:

Mostly Nuclear Physics

- ◆ EDMs of e , n , atoms, etc.
- ◆ Weak mixing angle
- ◆ $0\nu\beta\beta$
- ◆ Muon $g-2$
- ◆ Lepton flavor violation
- ◆ π , K and B decays
- ◆ Unitarity tests

Fermilab Muon g-2 result – new physics?

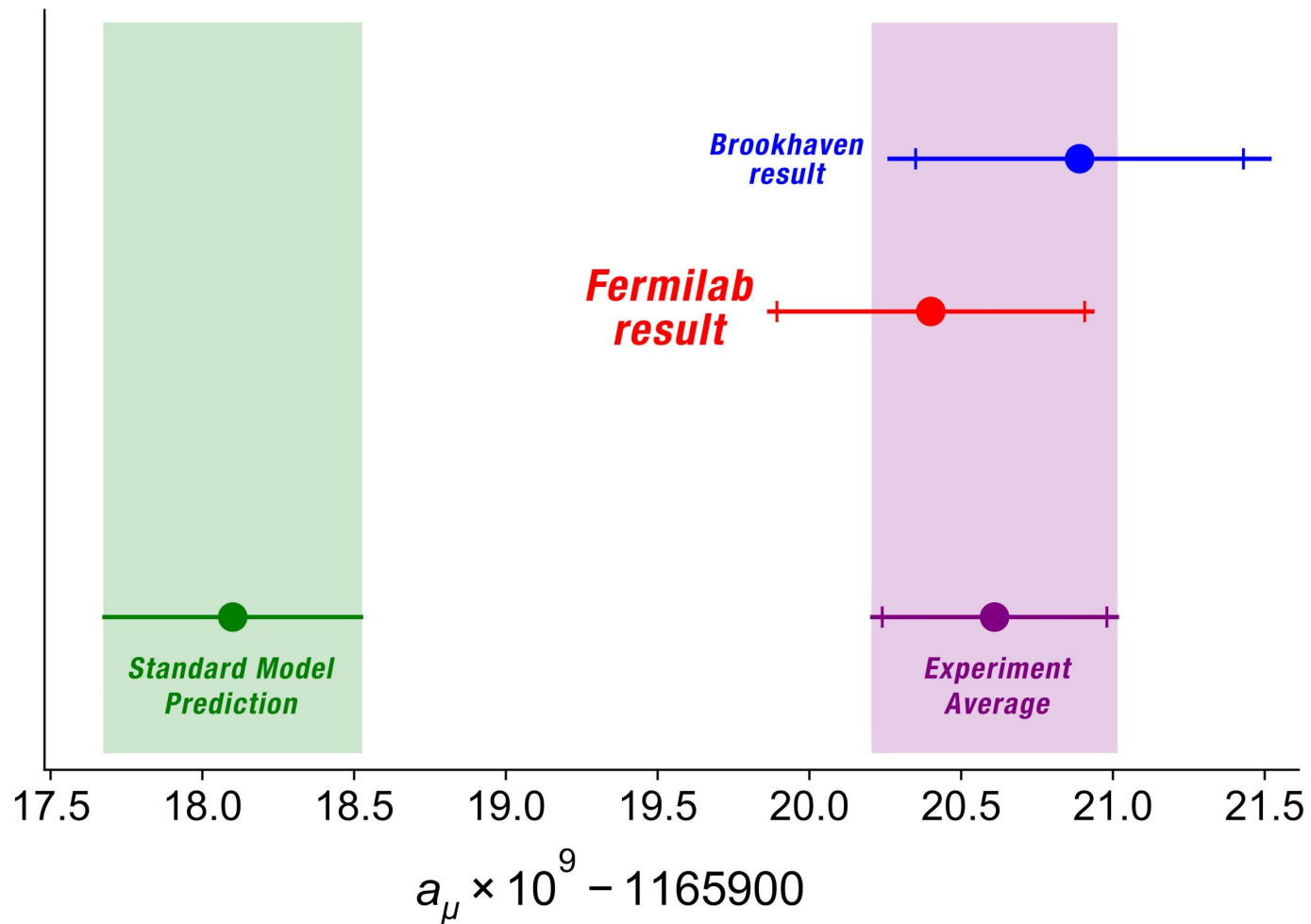

Theory: g-fac.: 2.00233183620(86) anomalous mag. moment: 0.00116591810(43)

Experiment: g-fac.: 2.00233184122(82), anomalous mag. moment: 0.00116592061(41)

Fermilab CDF new W mass Measurement

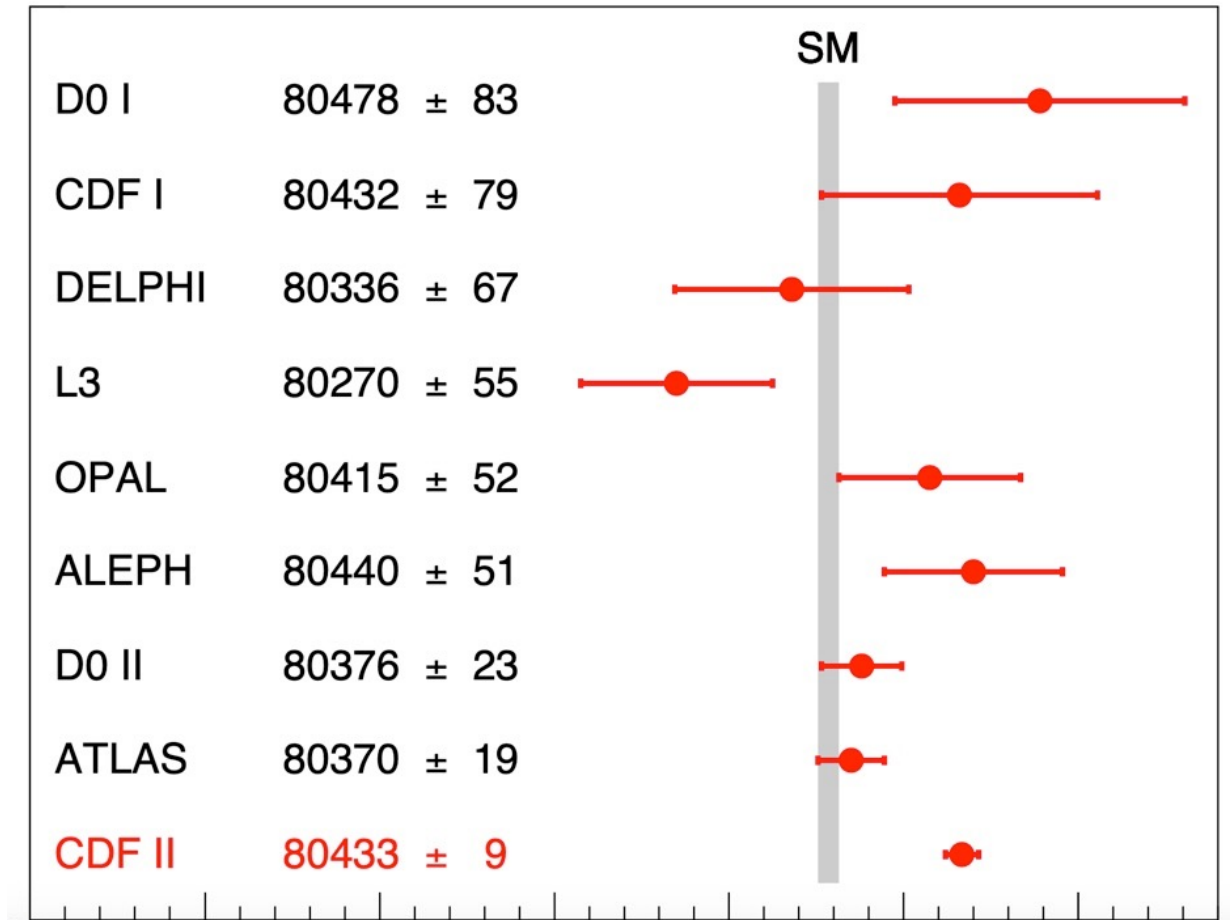

Seven standard deviations away from the theoretical prediction.

Neutrino Oscillation and Neutrino Mass

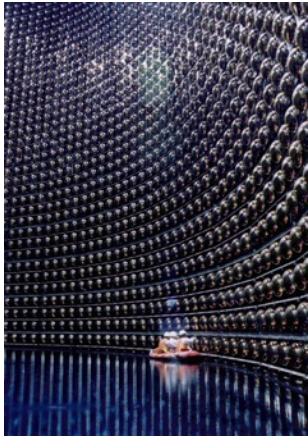

Super-K

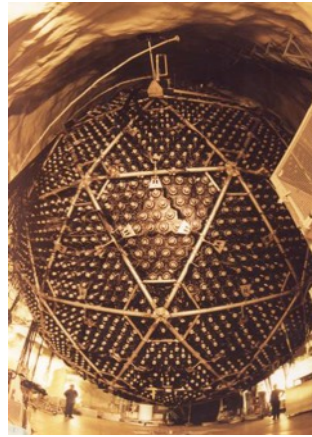

SNO



K2K

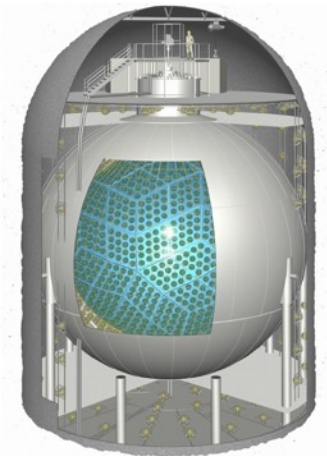

KamLand

Super-K: atmospheric ν_μ neutrino oscillation

SNO: solar ν_e flavor transformation

K2K: accelerator ν_μ oscillation

Kamland: reactor $\bar{\nu}_e$ disappearance and oscillation

Neutrinos have Mass

The first evidence of physics beyond the Standard Model!

The plot thickens – some good fortune ...

1983 experiments (for protons decay) also good neutrino detectors ... cross check **Homestake**.

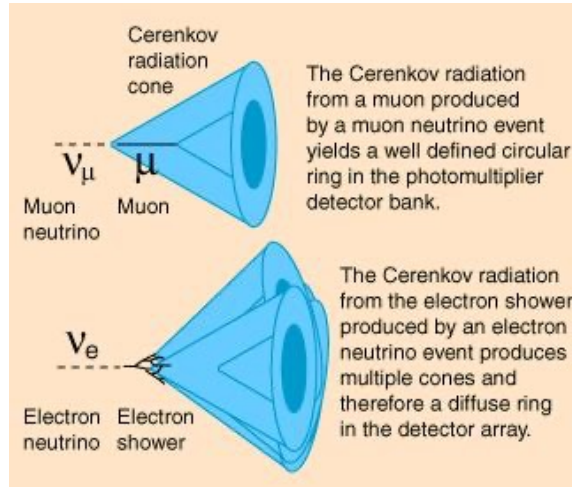

A massive detector, known as “SuperK”, clearly observed ν 's from the Sun, and confirmed the signal of missing solar ν 's.

In addition, SuperK was able to observe ν 's produced in the upper atmosphere by cosmic rays – “atmospheric ν 's”, and to tell where they were coming from, leading to a : **Breakthrough Observation in 1998**

In the Kamioka Mine in Japan

- Depth of 1000m
 - Water tank (3000 tons for the first one)
 - Instrumented to observe light flashes from produced from μ 's or e 's.
- (led by M. Koshiba, also a 2002 Nobelist)

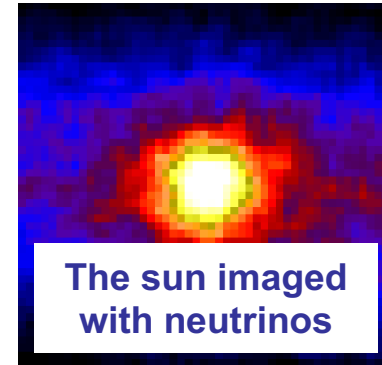

Particles are produced along the ν direction :
For the first time **directional information**.

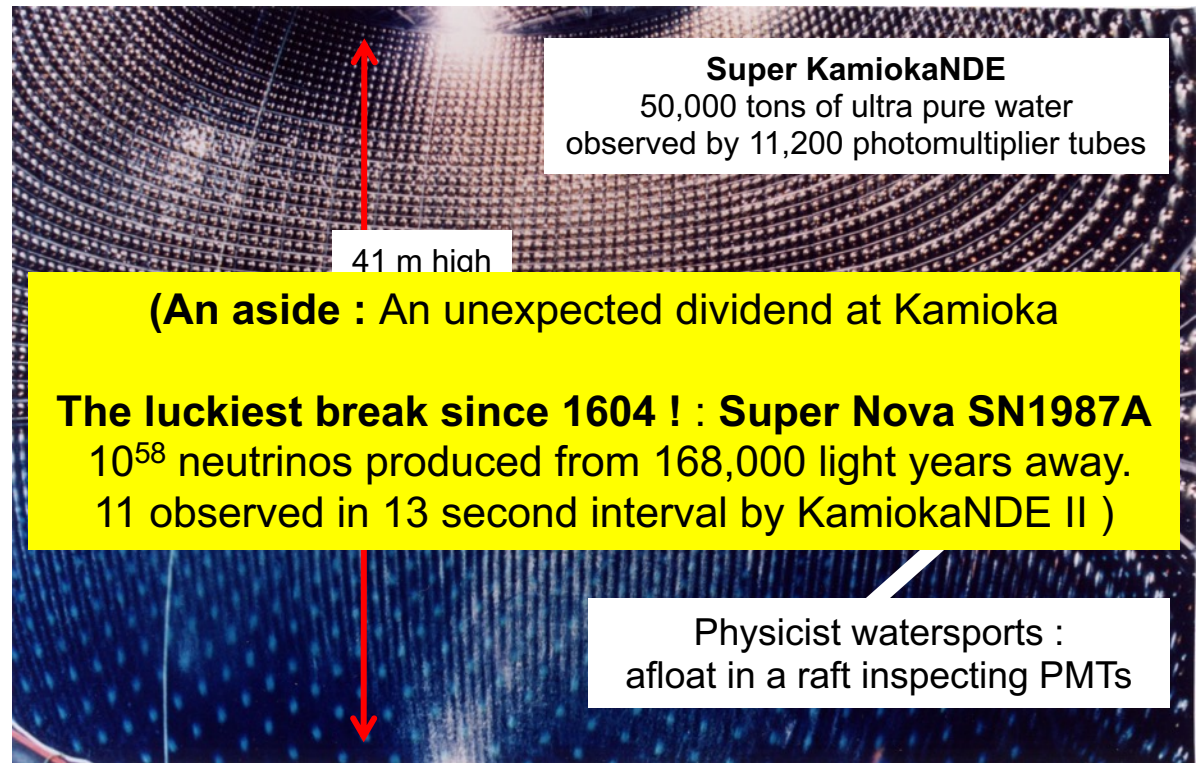

Atmospheric Neutrino

Atmospheric neutrinos originate in cosmic ray “showers”

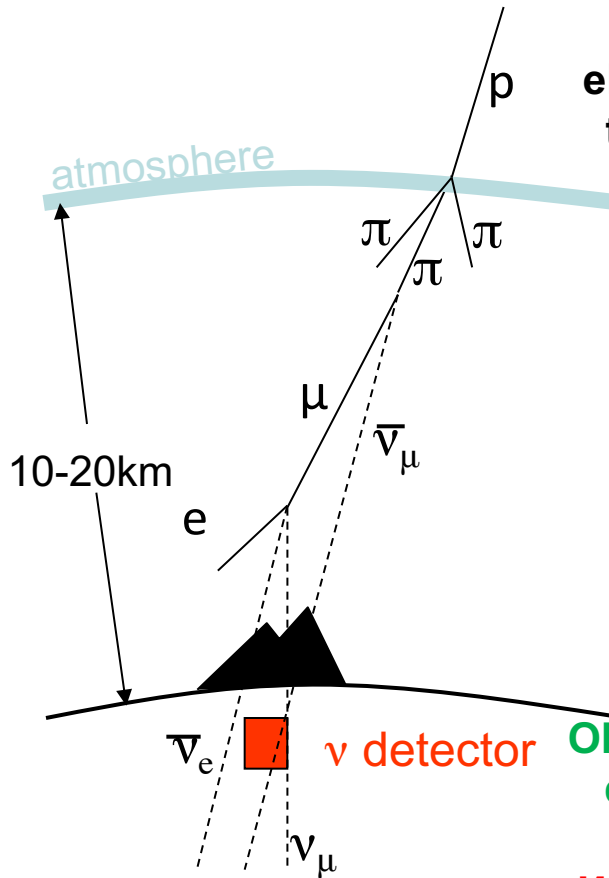

The **showers** produce **electron, muon (and tau) type neutrinos**, in a mix that can be predicted.

Neutrinos can reach SuperK from *above* or from *below* (the Earth is hardly a barrier at all to a neutrino, after all.)

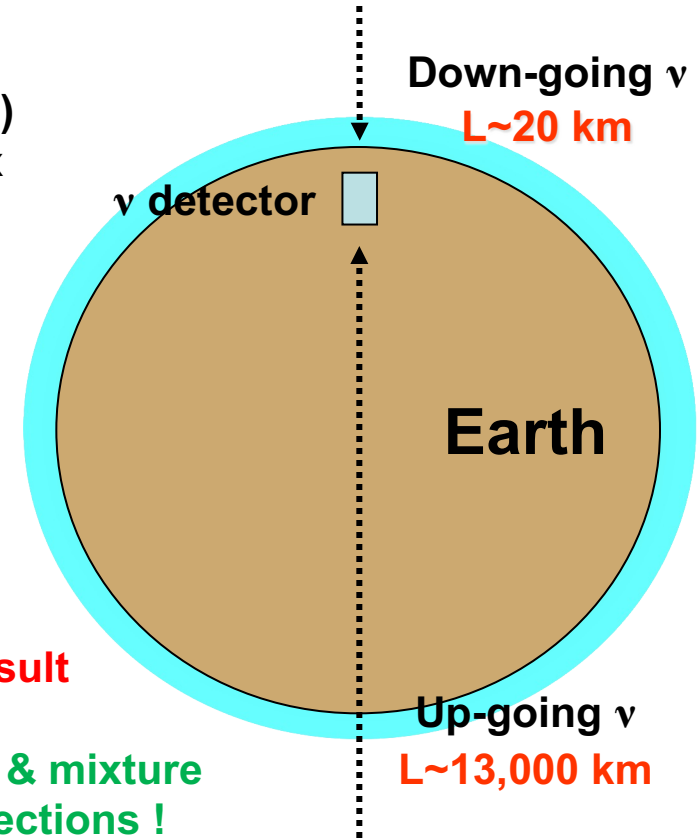

Stunning Result

Observed neutrino rates & mixture differed for the two directions !

Were flavors changing in transit ?

SNO

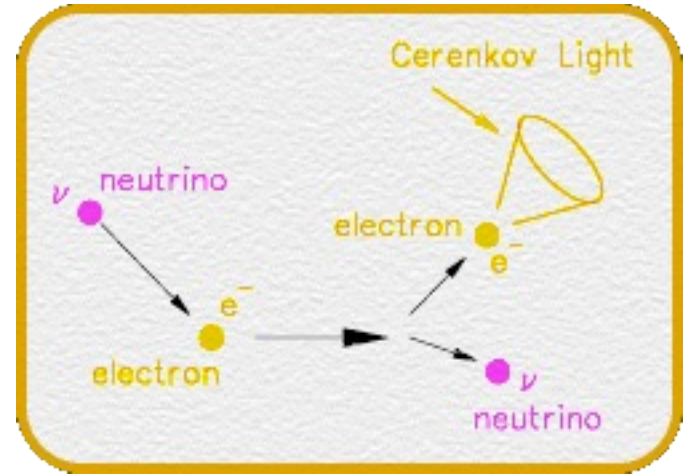

Electron Scattering

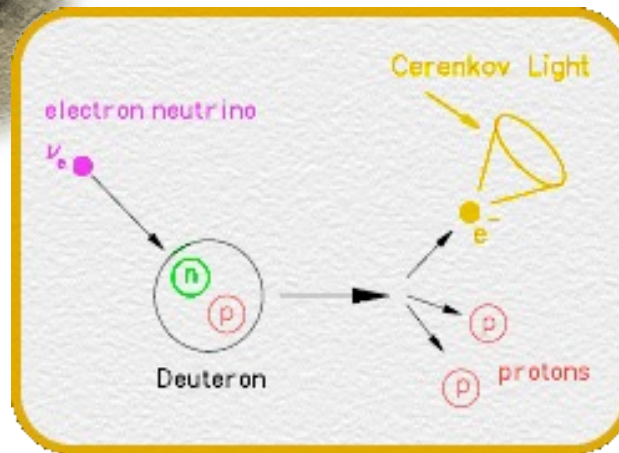

Charge Current

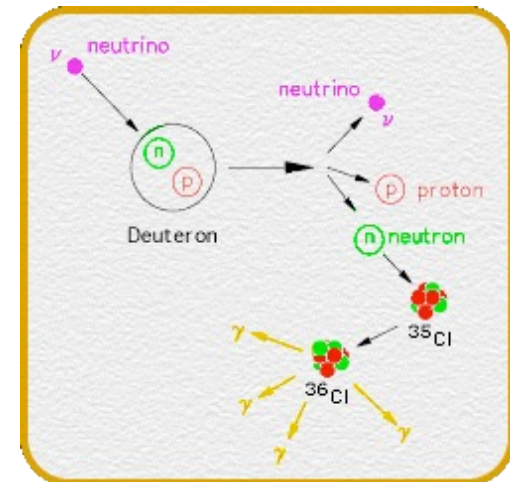

Neutral Current

2002 Sudbury Neutrino Observatory

Unknown Properties of Neutrinos

Major Questions in Neutrino Physics

- Majorana particle, (i.e. its own antiparticle)
- Absolute mass scale of neutrinos.
- Mass hierarchy
- CP violation phase
- Anomalies (Sterile neutrinos?)

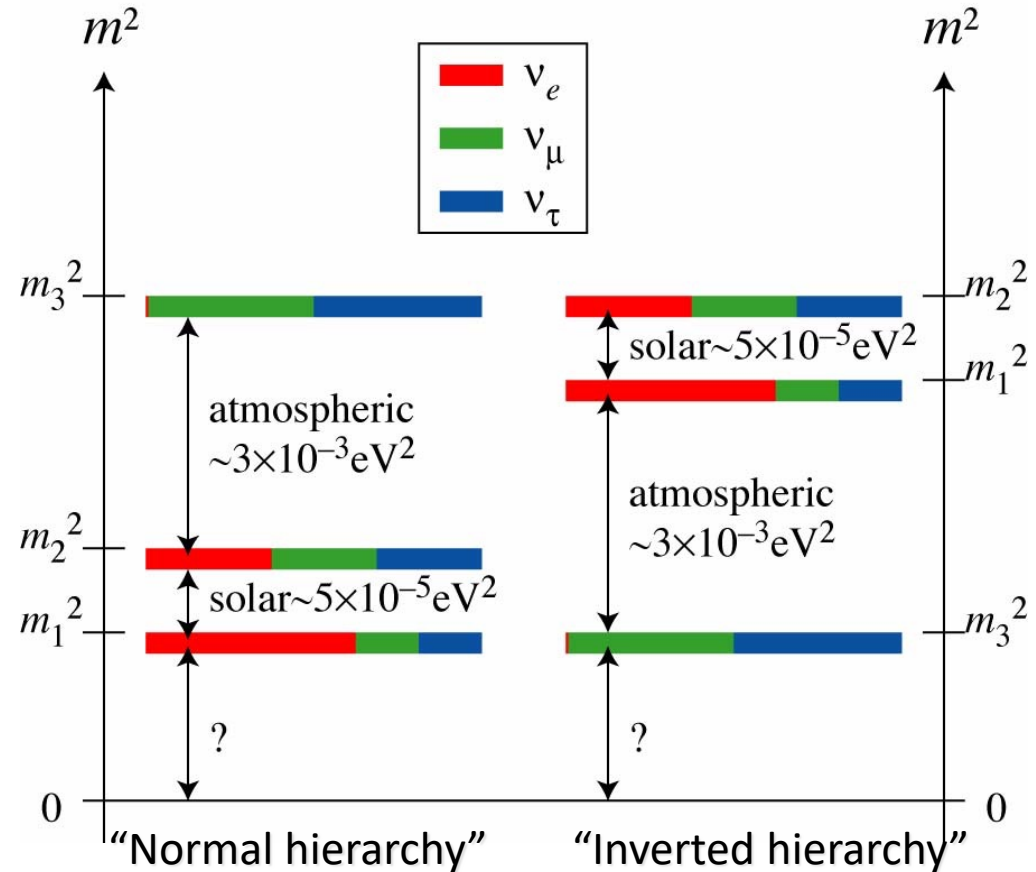

Double Beta Decay

Observable if single beta decay is forbidden

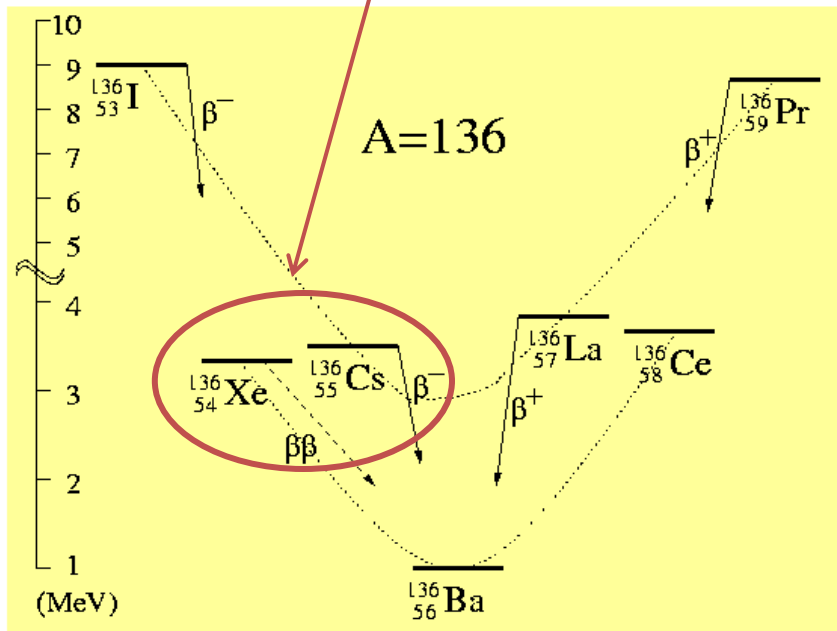

Two neutrino double beta decay

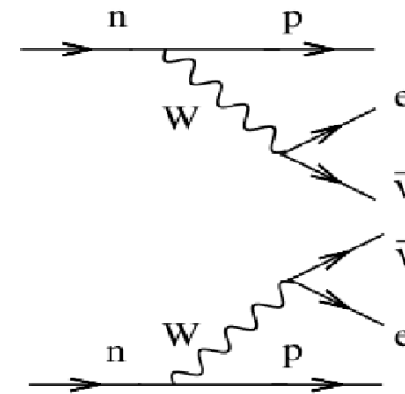

Neutrinoless double beta decay

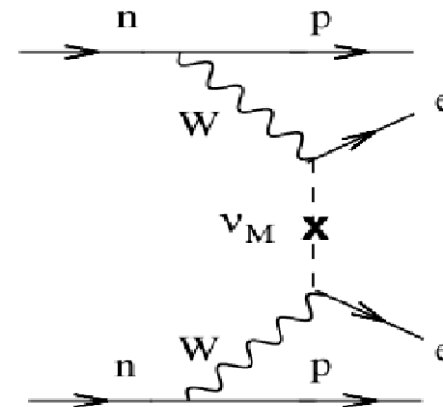

Observation of $0\nu\beta\beta$:

- Majorana neutrino
- Neutrino mass scale
- Lepton number violation

The EXO-200 Detector

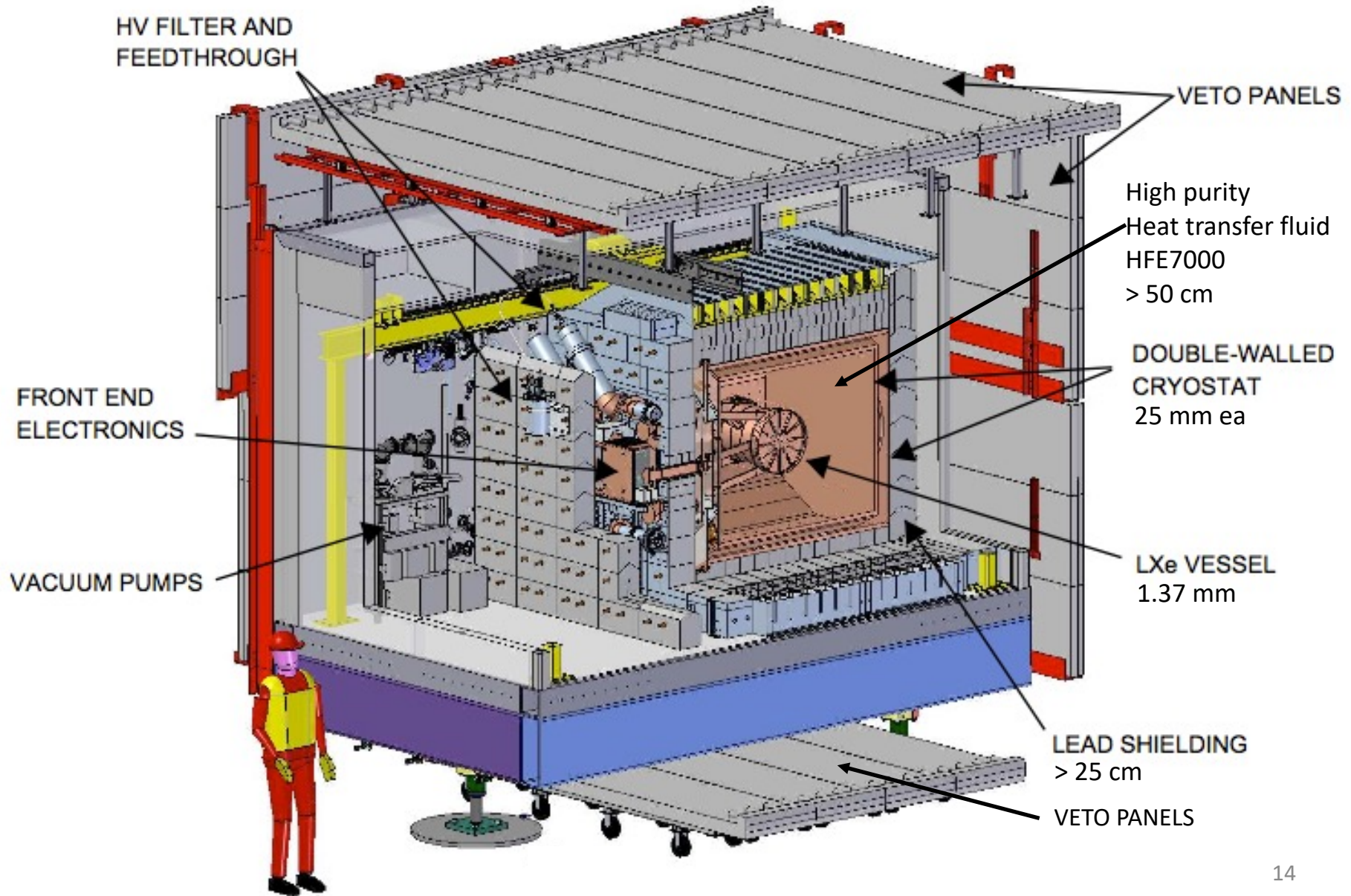

Liquid Xenon Time Projection Chamber

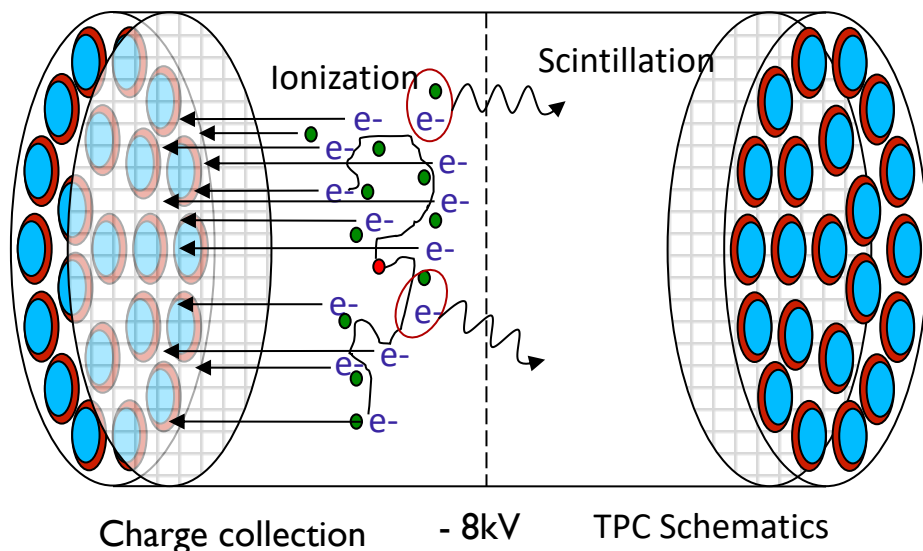

The EXO-200 time projection chamber uses both scintillation and ionization signals to fully reconstruct energy depositions inside liquid xenon

Single Site Events (SS)

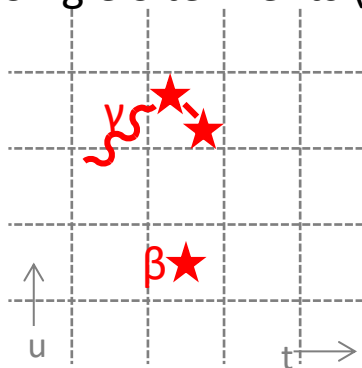

Multiple Site Events (MS)

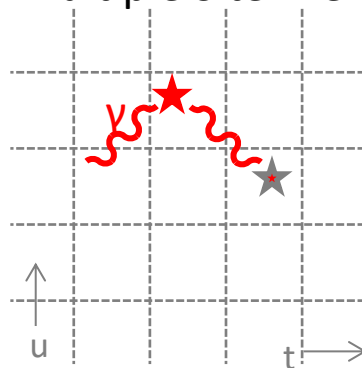

Event topology is a powerful tool not only for gamma background rejection, but also for signal discovery.

EXO-200 installation site: WIPP

EXO-200
location

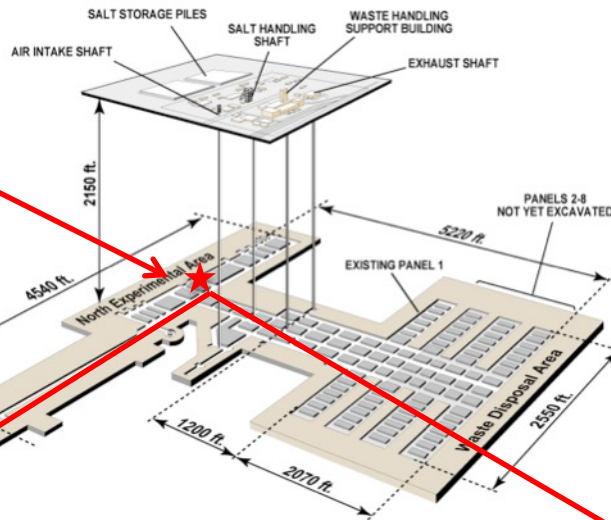

- EXO-200 installed at WIPP (Waste Isolation Pilot Plant), in Carlsbad, NM
- 1600 mwe flat overburden (2150 feet, 650 m)
- U.S. DOE salt mine for low-level radioactive waste storage
- Cleanroom installed on adjustable stands to compensate salt movements.
- Salt “rock” low activity relative to hard-rock mine

$$\Phi_{\mu} \sim 1.5 \times 10^5 \text{ yr}^{-1} \text{ m}^{-2} \text{ sr}^{-1}$$

$$U \sim 0.048 \text{ ppm}$$

$$Th \sim 0.25 \text{ ppm}$$

$$K \sim 480 \text{ ppm}$$

Esch et al., arxiv:astro-ph/0408486 (2004)



EXO-200 $0\nu\beta\beta$ Results

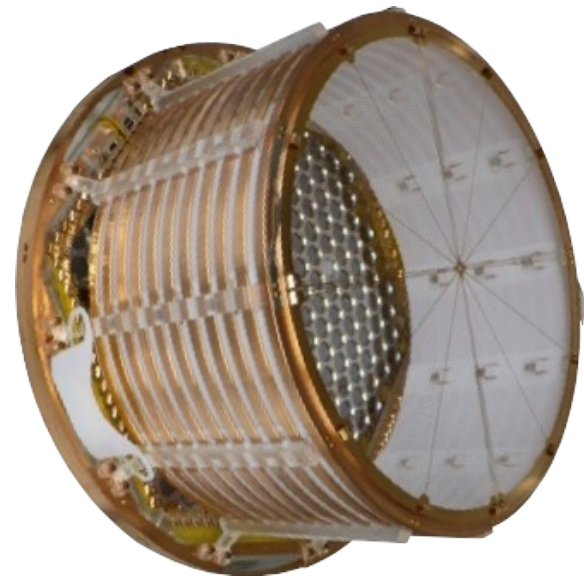

EXO-200 TPC

Combined Phase I + II:

Limit $T_{1/2}^{0\nu\beta\beta} > 3.5 \times 10^{25}$ yr (90% C.L.)

$\langle m_{\beta\beta} \rangle < (93 - 286)$ meV

Sensitivity 5.0×10^{25} yr

2012: *Phys. Rev. Lett.* 109, 032505

2014: *Nature* 510, 229-234

2018: *Phys. Rev. Lett.* 120, 072701

2019: *Phys. Rev. Lett.* 123, 161802

- EXO-200 uses liquid xenon time projection chamber (TPC) to search for $0\nu\beta\beta$ of ^{136}Xe
- Successful operation from 2011 – 2018 with total ^{136}Xe isotope exposure of 234.1 kg·yr.
- Experimental sensitivities continue to exceed statistics due to improvements in hardware and analysis.
- Setting one of the strongest limits on this rare decay.

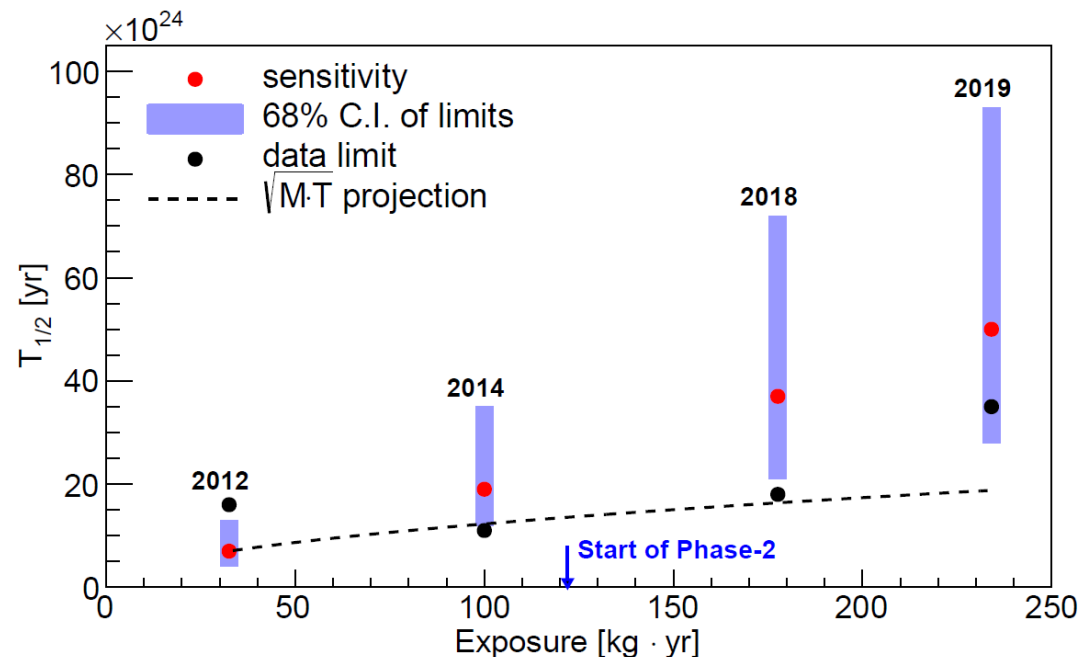

From EXO-200 to nEXO

EXO-200 as a technology demonstrator

nEXO: a 5000 kg enriched LXe TPC

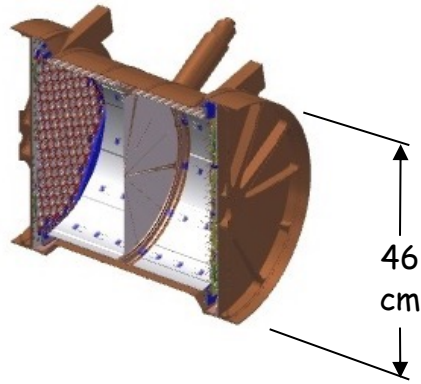

2.5MeV γ
attenuation length
8.5cm = —

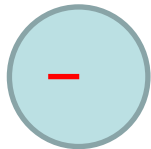

150kg

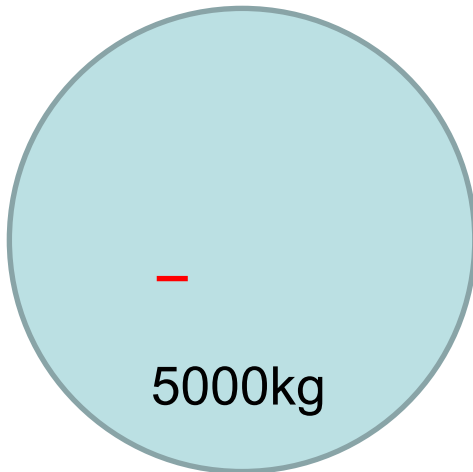

5000kg

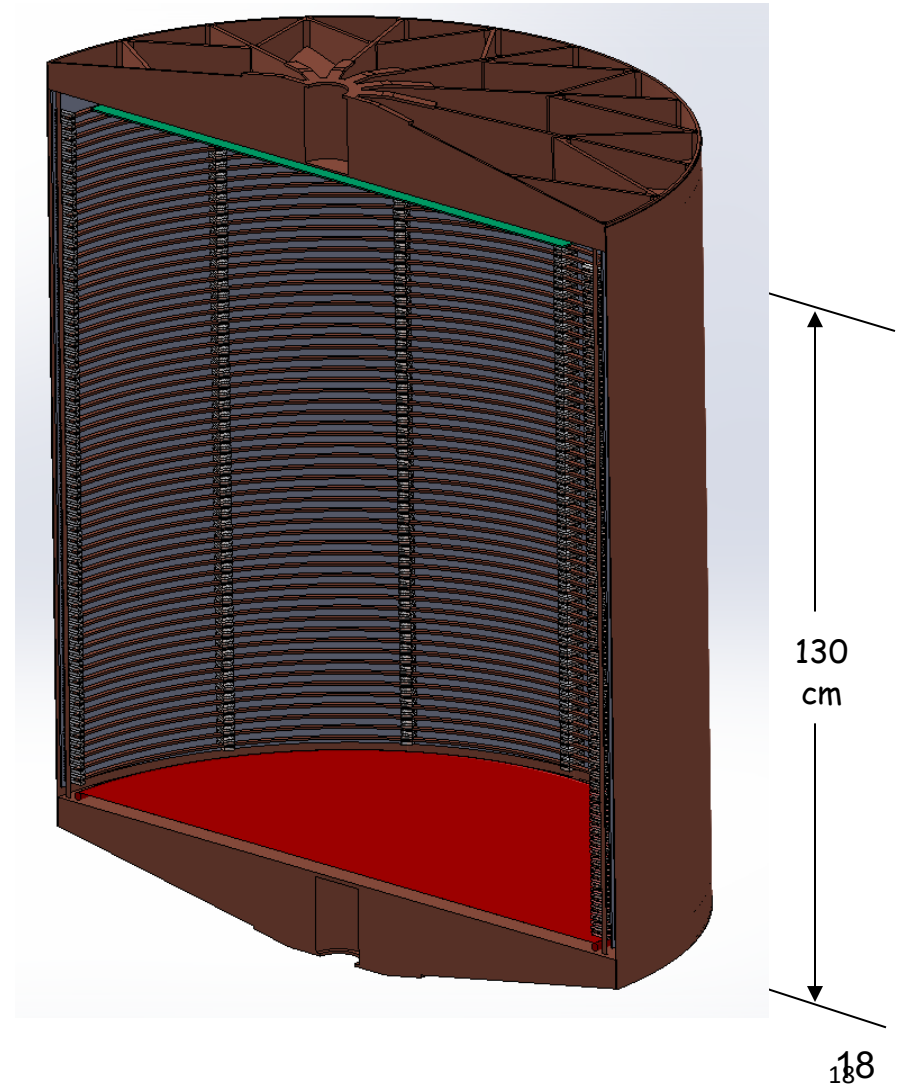

Pre-Conceptual Design of nEXO

- 5 tones of single phase LXe TPC.
- Ionization charge collected by anode.
- 178nm lights detected by $\sim 4 \text{ m}^2$ SiPM array behind field shaping rings.
- Combining light and charge to enhance the energy resolution.

nEXO pre-CDR, arXiv:1805.11142

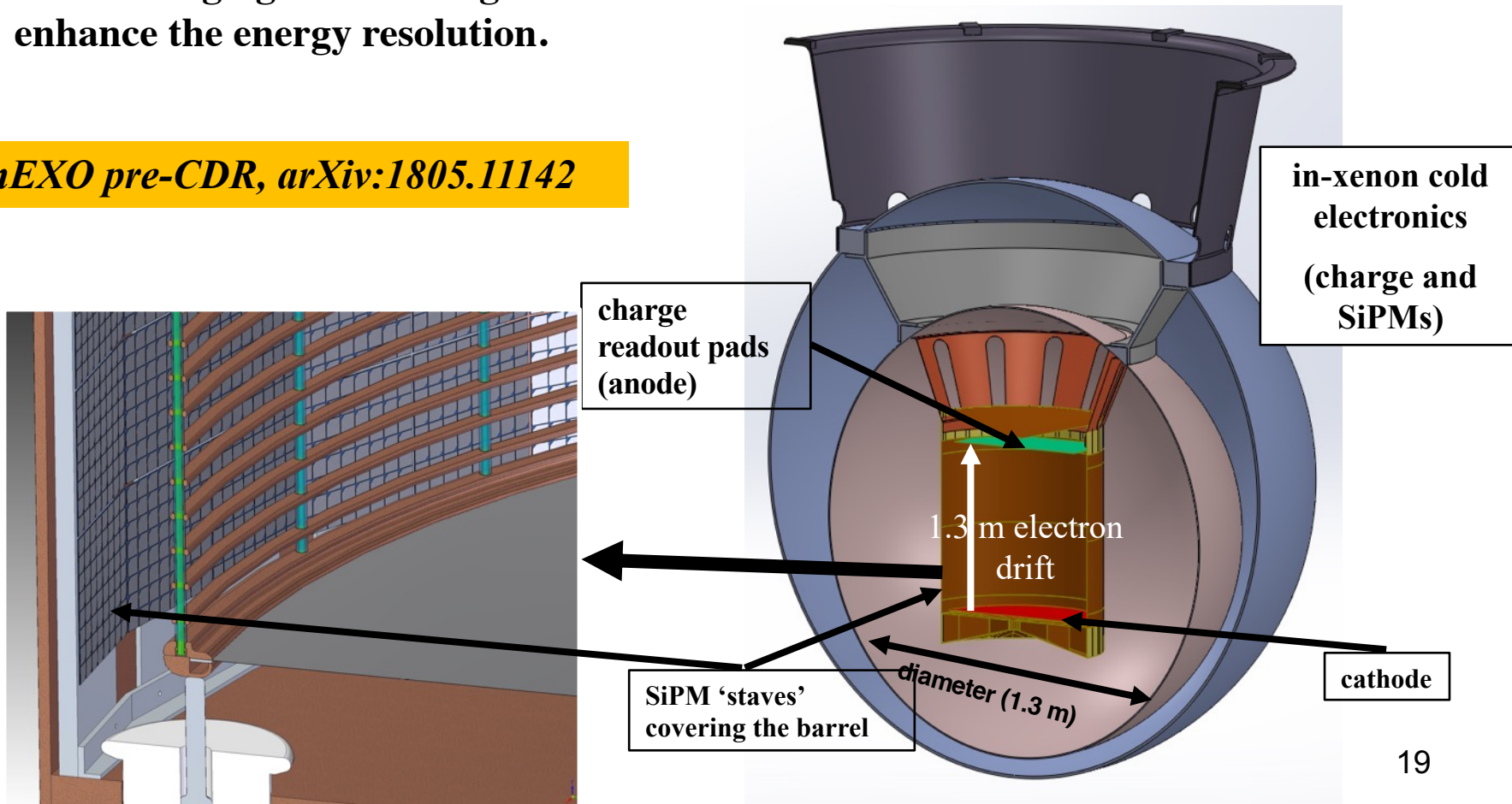

Tagging $\beta\beta$ decay daughter Ba

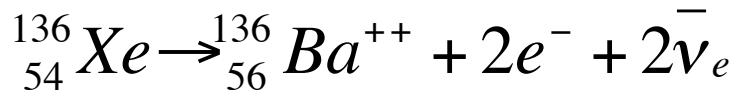

≤ 58 -atom

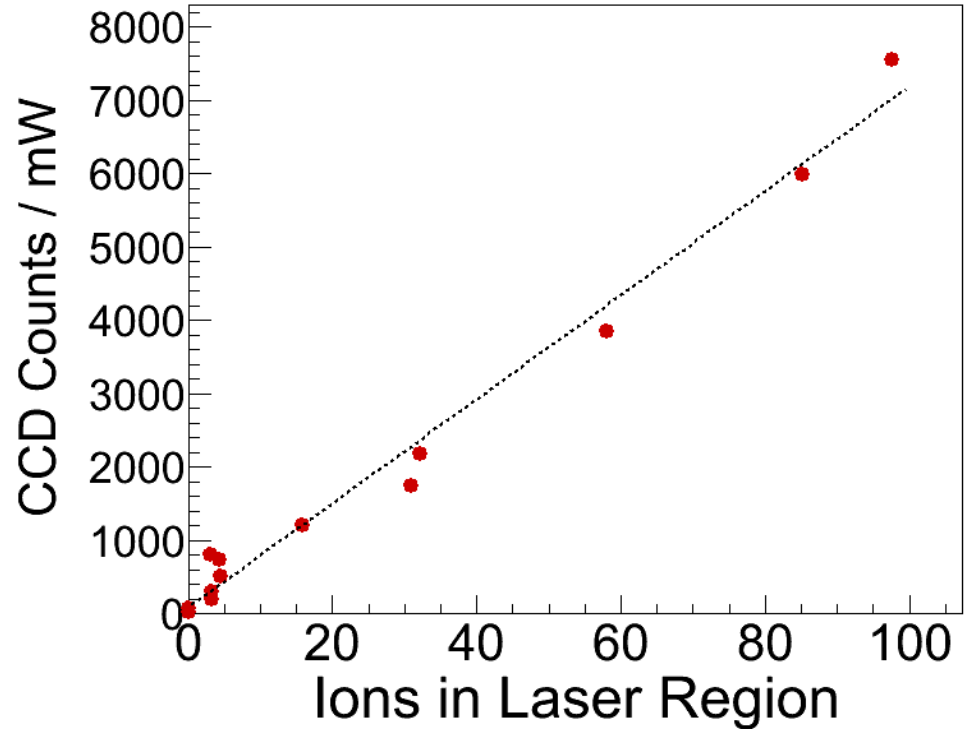
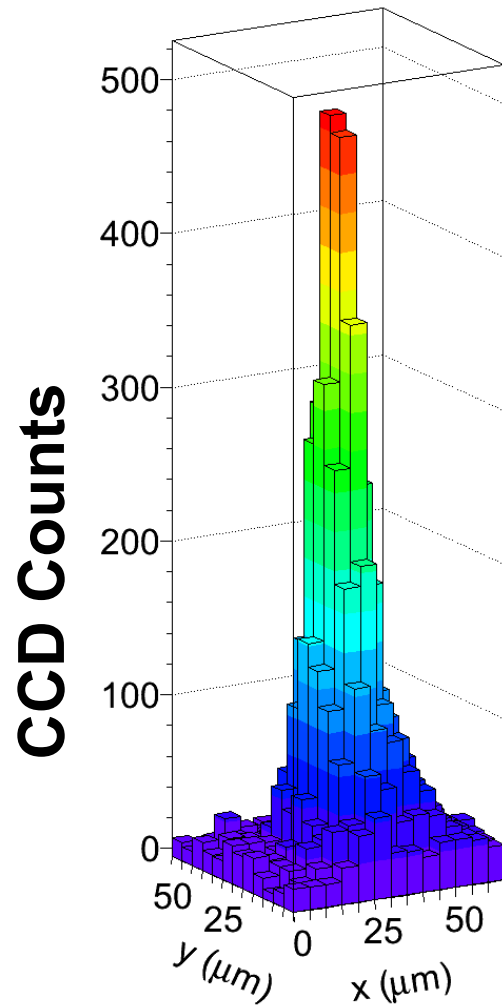

≤ 15 -atom

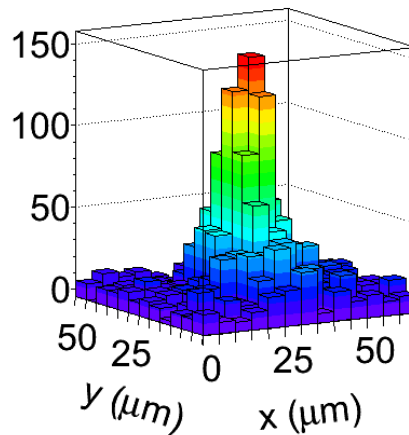

≤ 4 -atom

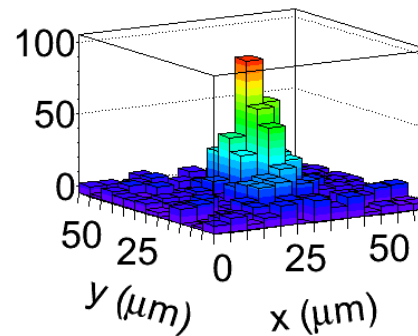

0-atom

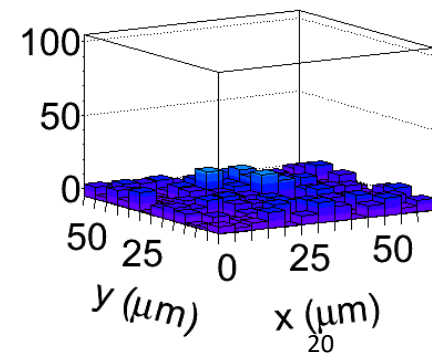

nEXO Sensitivity (with Ba tagging)

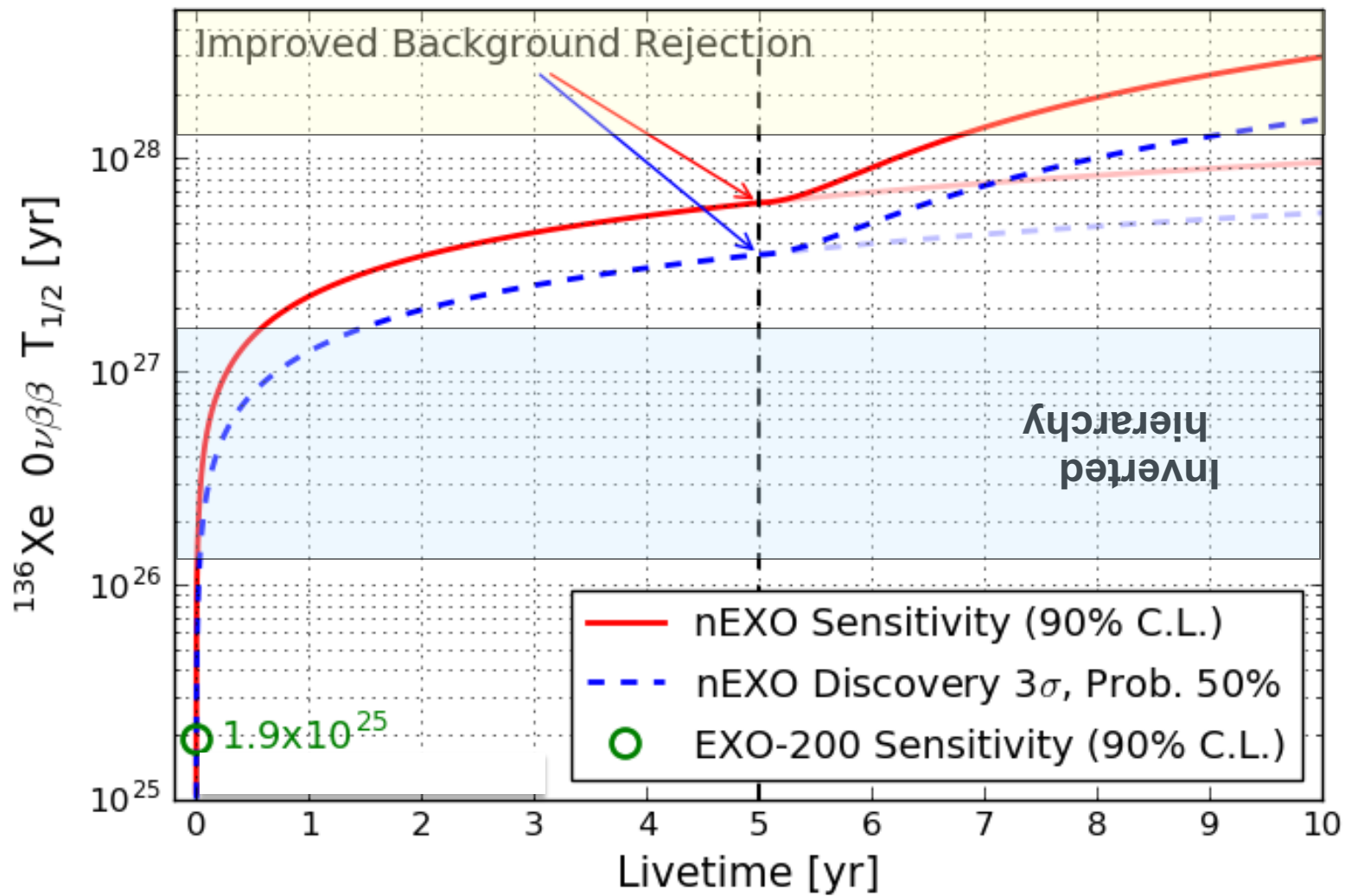

Normal hierarchy

GCM: Rodriguez, Martinez-Pinedo,
Phys. Rev. Lett. 105 (2010) 252503

[nEXO Sensitivity Paper: arXiv:1710.05075](https://arxiv.org/abs/1710.05075)

What can Neutrino tell us about the Universe?

- What role did neutrino play in the evolution of the universe? ($\sim 4\%$ mass of the universe, absolute mass scale? Number of species? ... double beta decay experiment, tritium decay experiment, sterile neutrino search...)
- Can neutrino be responsible for the matter and anti-matter asymmetry? (CP violation phase? ... long baseline neutrino experiment)
- Neutrino might be the best probe deep into the universe (IceCube...)
- Supernovae neutrinos, relic neutrinos...