

Plan of the Lecture

- ▶ **Review:** stability; Routh–Hurwitz criterion
- ▶ **Today's topic:** basic properties and benefits of feedback control

Goal: understand the difference between open-loop and closed-loop (feedback) control; examine the benefits of feedback: reference tracking and disturbance rejection; reduction of sensitivity to parameter variations; improvement of time response.

Reading: FPE, Section 4.1; lab manual

Two Basic Control Architectures

- ▶ Open-loop control

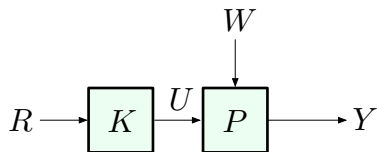

- ▶ Feedback (closed-loop) control

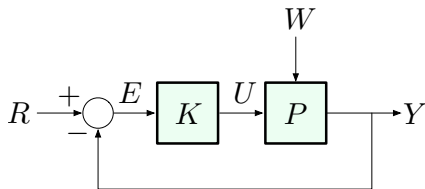

Here, W is a *disturbance*; K is *not necessarily* a static gain

Basic Objectives of Control

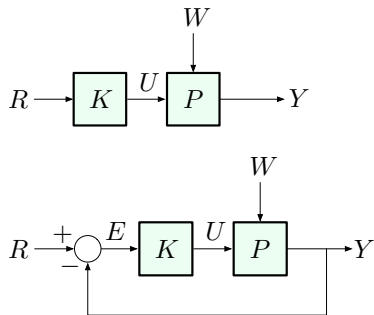

- ▶ track a given reference
- ▶ reject disturbances
- ▶ meet performance specs

Intuitively, the difference between the open-loop and the closed-loop architectures is clear (think cruise control ...)

Open-Loop Control

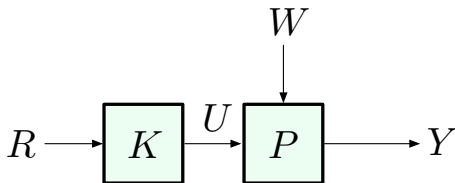

- ▶ cheaper/easier to implement (no sensor required)
- ▶ does not destabilize the system

e.g., if both K and P are stable (all poles in OLHP),

$$\frac{Y}{R} = KP$$

is also stable:

$$\{\text{poles of } KP\} = \{\text{poles of } K\} \cup \{\text{poles of } P\}$$

Feedback Control

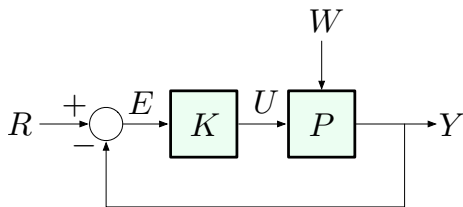

- ▶ more difficult/expensive to implement (requires a sensor and an information path from controller to actuator)
- ▶ may destabilize the system:

$$\frac{Y}{R} = \frac{KP}{1 + KP}$$

has new poles, which may be unstable

- ▶ **but:** feedback control is the *only way* to stabilize an unstable plant (this was the Wright brothers' key insight)

Benefits of Feedback Control

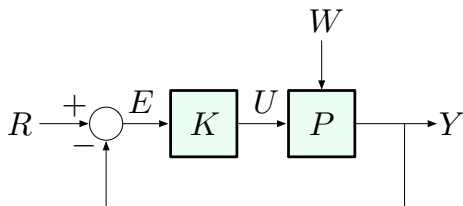

Feedback control:

- ▶ reduces steady-state error to disturbances
- ▶ reduces steady-state sensitivity to model uncertainty (parameter variations)
- ▶ improves time response

Case Study: DC Motor

Inputs: v_a – input voltage

τ_e – load/disturbance torque

Outputs: ω_m – angular speed of the motor

Transfer function:

$$\Omega_m = \frac{A}{\tau s + 1} V_a + \frac{B}{\tau s + 1} T_e$$

τ – time constant
 A, B – system gains

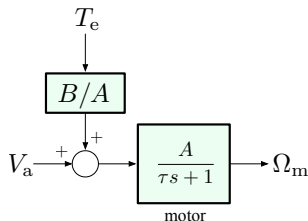

Objective: have Ω_m approach and track a given reference Ω_{ref} in spite of disturbance T_e .

Two Control Configurations

- ▶ Open-loop control

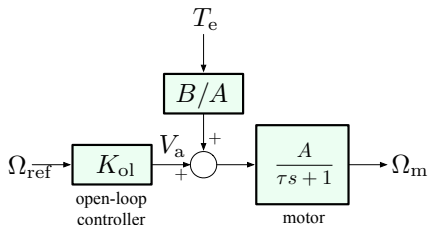

- ▶ Feedback (closed-loop) control

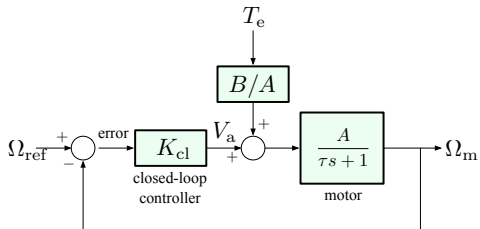

Disturbance Rejection

Goal: maintain $\omega_m = \omega_{\text{ref}}$ in steady state in the presence of *constant* disturbance.

Open-loop:

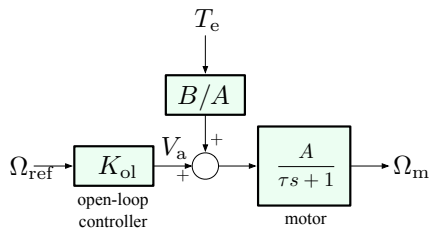

- the controller receives *no information* about the disturbance τ_e (the only input is ω_{ref} , no feedback signal from anywhere else)
- so, let's attempt the following: design for *no disturbance* (i.e., $\tau_e = 0$), then see how the system works in general

Disturbance Rejection: Open-Loop Control

First assume zero disturbance:

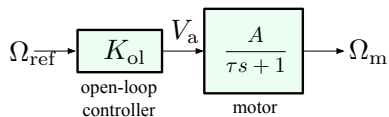

Transfer function:

$$\frac{A}{\tau s + 1} \quad (\text{stable pole at } s = -1/\tau)$$

We want DC gain = 1

$$\Omega_m = \frac{A}{\tau s + 1} V_a = \frac{K_{ol} A}{\tau s + 1} \Omega_{ref}$$

Let's just use constant gain: $K_{ol} = 1/A$

$$\omega_m(\infty) = \frac{1}{A} \cdot A \cdot \omega_{ref} = \omega_{ref} \quad (\text{for } T_e = 0)$$

What happens in the presence of nonzero T_e ?

$$\Omega_m = \underbrace{\frac{A}{\tau s + 1} \frac{1}{A}}_{\text{DC gain}=1} \Omega_{ref} + \underbrace{\frac{B}{\tau s + 1}}_{\text{DC gain}=B} T_e$$

$$\implies \omega_m(\infty) = \underbrace{\omega_{ref}}_{\text{step input}} + B \underbrace{\tau_e}_{\text{step input}}$$

Disturbance Rejection: Open-Loop Control

Steady-state motor speed for constant reference and constant disturbance:

$$\omega_m(\infty) = \omega_{\text{ref}} + B\tau_e$$

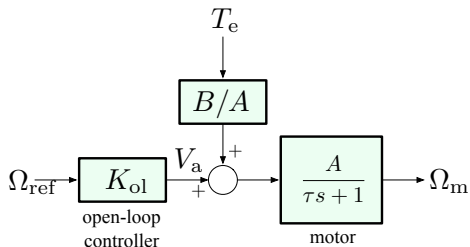

Conclusion: in the absence of disturbances, reference tracking is good, but disturbance rejection is pretty poor. Steady-state error is determined by B , and we have no control over it (and, in fact, cannot change this through any choice of controller K_{ol} , no matter how clever)

Disturbance Rejection: Feedback Control

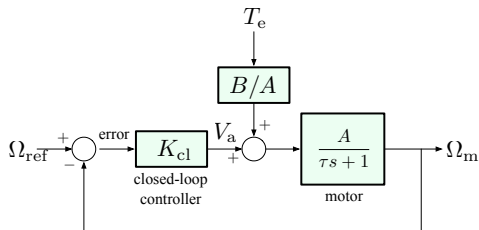

$$V_a = K_{cl}E = K_{cl}(\Omega_{ref} - \Omega_m)$$

$$\Omega_m = \frac{A}{\tau s + 1}K_{cl}(\Omega_{ref} - \Omega_m) + \frac{B}{\tau s + 1}T_e$$

Solve for Ω_m : $(\tau s + 1)\Omega_m = AK_{cl}(\Omega_{ref} - \Omega_m) + BT_e$
 $(\tau s + 1 + AK_{cl})\Omega_m = AK_{cl}\Omega_{ref} + BT_e$

$$\Omega_m = \frac{AK_{cl}}{\tau s + 1 + AK_{cl}}\Omega_{ref} + \frac{B}{\tau s + 1 + AK_{cl}}T_e$$

Disturbance Rejection: Feedback Control

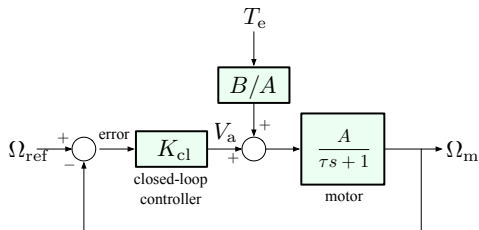

$$\Omega_m = \underbrace{\frac{AK_{cl}}{\tau s + 1 + AK_{cl}}}_{\text{DC gain} = \frac{AK_{cl}}{1 + AK_{cl}}} \Omega_{ref} + \underbrace{\frac{B}{\tau s + 1 + AK_{cl}}}_{\text{DC gain} = \frac{B}{1 + AK_{cl}}} T_e$$

(provided all transfer functions are strictly stable)

Assuming that the reference ω_{ref} and the disturbance τ_e are constant, we apply FVT:

$$\omega_m(\infty) = \frac{AK_{cl}}{1 + AK_{cl}} \omega_{ref} + \frac{B}{1 + AK_{cl}} \tau_e$$

Disturbance Rejection: Feedback Control

Steady-state speed for constant reference and disturbance:

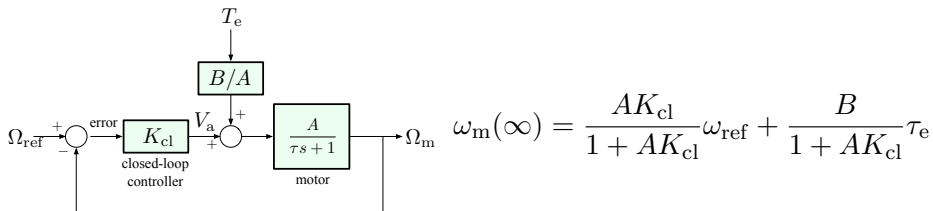

Conclusions:

- ▶ $\frac{AK_{\text{cl}}}{1 + AK_{\text{cl}}} \neq 1$, but can be brought arbitrarily close to 1 when $K_{\text{cl}} \rightarrow \infty$. Thus, steady-state tracking is good with high gain, but never quite as good as in open-loop case.
- ▶ $\frac{B}{1 + AK_{\text{cl}}}$ is small (arbitrarily close to 0) for large K_{cl} . Thus, *much* better disturbance rejection than with open-loop control.

Sensitivity to Parameter Variations

Consider again our DC motor model, with no disturbance:

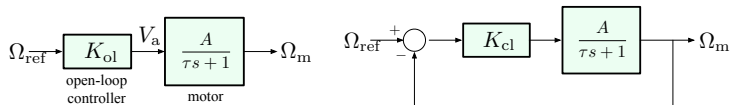

Bode's sensitivity concept: In the “nominal” situation, we have the motor with DC gain = A , and the overall transfer function, either open- or closed-loop, has some other DC gain (call it T).

Now suppose that, due to modeling error, changes in operating conditions, etc., the motor gain changes:

$$A \longrightarrow A + \underbrace{\delta A}_{\substack{\text{small} \\ \text{perturbation}}}$$

This will cause a perturbation in the overall DC gain:

$$T \longrightarrow T + \delta T \quad \left(\text{from calculus, to 1st order, } \delta T \approx \frac{dT}{dA} \delta A\right)$$

Sensitivity to Parameter Variations

$A \longrightarrow A + \delta A$ (small perturbation in system gain)

$T \longrightarrow T + \delta T$ (resultant perturbation in overall DC gain)



Hendrik Wade Bode
(1905–1982)

Bode's sensitivity:

$$\mathcal{S} \triangleq \frac{\delta T/T}{\delta A/A}$$

\mathcal{S} = relative error

$$= \frac{\text{normalized (percentage) error in } T}{\text{normalized (percentage) error in } A}$$

Sensitivity to Parameter Variations

Let's compute \mathcal{S} for our DC motor control example, both open- and closed-loop.

Open-loop:

- ▶ nominal case $T_{ol} = K_{ol}A = \frac{1}{A}A = 1$
- ▶ perturbed case

$$A \longrightarrow A + \delta A$$

$$T_{ol} \longrightarrow K_{ol}(A + \delta A) = \underbrace{\frac{1}{A}}_{\text{design choice}} (A + \delta A) = \underbrace{1}_{T_{ol}} + \underbrace{\frac{\delta A}{A}}_{\delta T_{ol}}$$

$$\text{Sensitivity: } \mathcal{S}_{ol} = \frac{\delta T_{ol}/T_{ol}}{\delta A_{ol}/A_{ol}} = \frac{\delta A/A}{\delta A/A} = 1$$

For example, a 5% error in A will cause a 5% error in T_{ol} .

Sensitivity to Parameter Variations

Closed-loop:

- ▶ nominal case $T_{cl} = \frac{AK_{cl}}{1 + AK_{cl}}$
- ▶ perturbed case

$$A \longrightarrow A + \delta A \quad T_{cl} \longrightarrow T_{cl} + \underbrace{\delta T_{cl}}_{\text{how to compute this?}}$$

Taylor expansion:

$$T(A + \delta A) = T(A) + \frac{dT}{dA}(A)\delta A + \text{higher-order terms}$$

In our case:

$$\begin{aligned} \frac{dT_{cl}}{dA} &= \frac{K_{cl}}{1 + AK_{cl}} - \frac{AK_{cl}^2}{(1 + AK_{cl})^2} = \frac{K_{cl}}{(1 + AK_{cl})^2} \\ \delta T_{cl} &= \frac{K_{cl}}{(1 + AK_{cl})^2} \delta A \end{aligned}$$

Sensitivity to Parameter Variations

From before:

$$\delta T_{cl} = \frac{K_{cl}}{(1 + AK_{cl})^2} \delta A$$
$$T_{cl} = \frac{AK_{cl}}{1 + AK_{cl}}$$

Therefore

$$\delta T_{cl}/T_{cl} = \frac{\frac{K_{cl}}{(1+AK_{cl})^2} \delta A}{\frac{AK_{cl}}{1+AK_{cl}}} = \frac{1}{1 + AK_{cl}} \delta A/A$$

Sensitivity: $\mathcal{S}_{cl} = \frac{\delta T_{cl}/T_{cl}}{\delta A/A} = \frac{1}{1 + AK_{cl}} \quad (\ll 1 \text{ for large } K_{cl})$

With high-gain feedback, we get smaller relative error due to parameter variations in the plant model.

Time Response

We still assume no disturbance: $\tau_e = 0$.

So far, we have focused on DC gain only (steady-state response). What about *transient response*?

Open-loop

$$\Omega_m = \frac{AK_{ol}}{\tau s + 1} \Omega_{ref}$$

Pole at $s = -\frac{1}{\tau} \implies$ transient response is $e^{-t/\tau}$

Here, τ is the *time constant*: the time it takes the system response to decay to $1/e$ of its starting value.

In the open-loop case, smaller time constant means faster convergence to steady state. This is not affected by the choice of K_{ol} in any way!

Time Response

Closed-loop

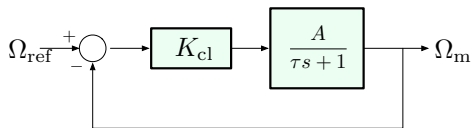

$$\Omega_m = \frac{AK_{cl}}{\tau s + 1 + AK_{cl}} \Omega_{ref}$$

Closed-loop pole at $s = -\frac{1}{\tau} (1 + AK_{cl})$
(the only way to move poles around is *via feedback*)

Now the transient response is $e^{-\frac{1+AK_{cl}}{\tau}t}$, with

$$\text{time constant} = \frac{\tau}{1 + AK_{cl}}$$

— for large K_{cl} , we have a much smaller time constant, i.e.,
faster convergence to steady-state.

Summary

Feedback control:

- ▶ reduces steady-state error to disturbances
- ▶ reduces steady-state sensitivity to model uncertainty (parameter variations)
- ▶ improves time response

Word of caution: high-gain feedback only works well for 1st-order systems; for higher-order systems, it will typically cause underdamping and instability.

Thus, we need a more sophisticated design than just static gain. We will take this up in the next lecture with *Proportional-Integral-Derivative (PID)* control.