

Pinhole Camera Model

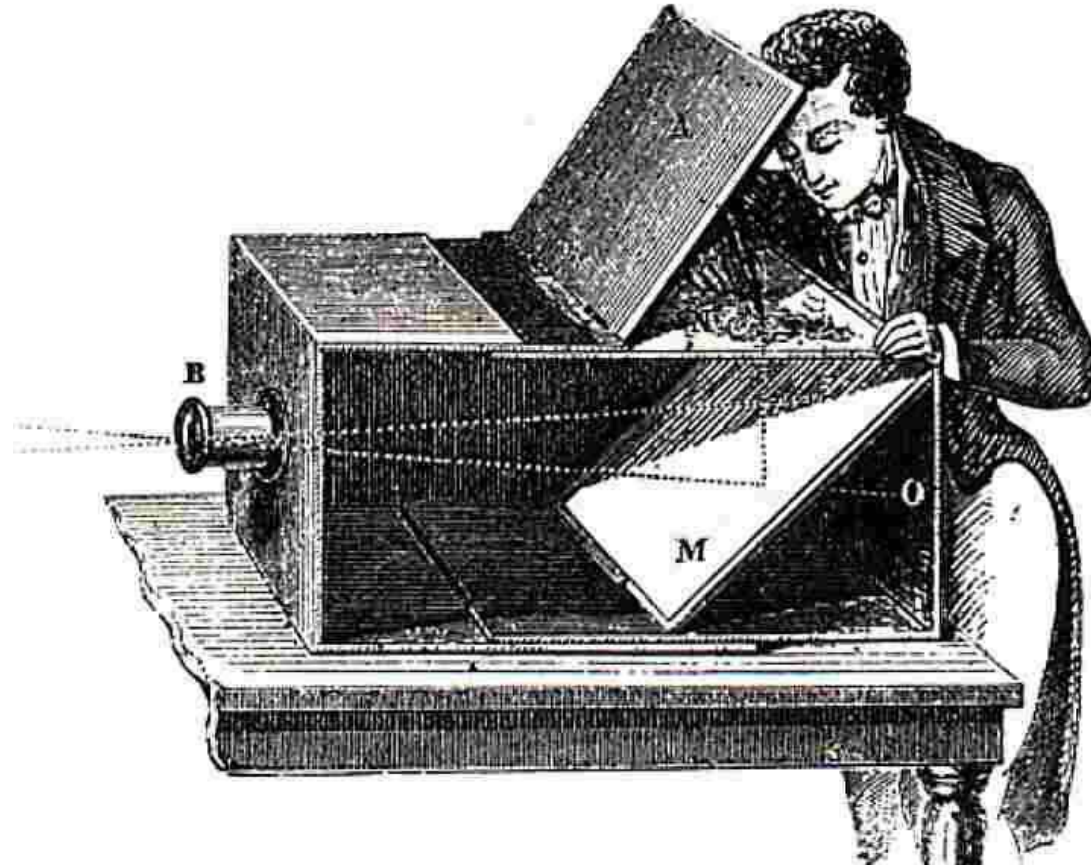

Computational Photography
Derek Hoiem, University of Illinois

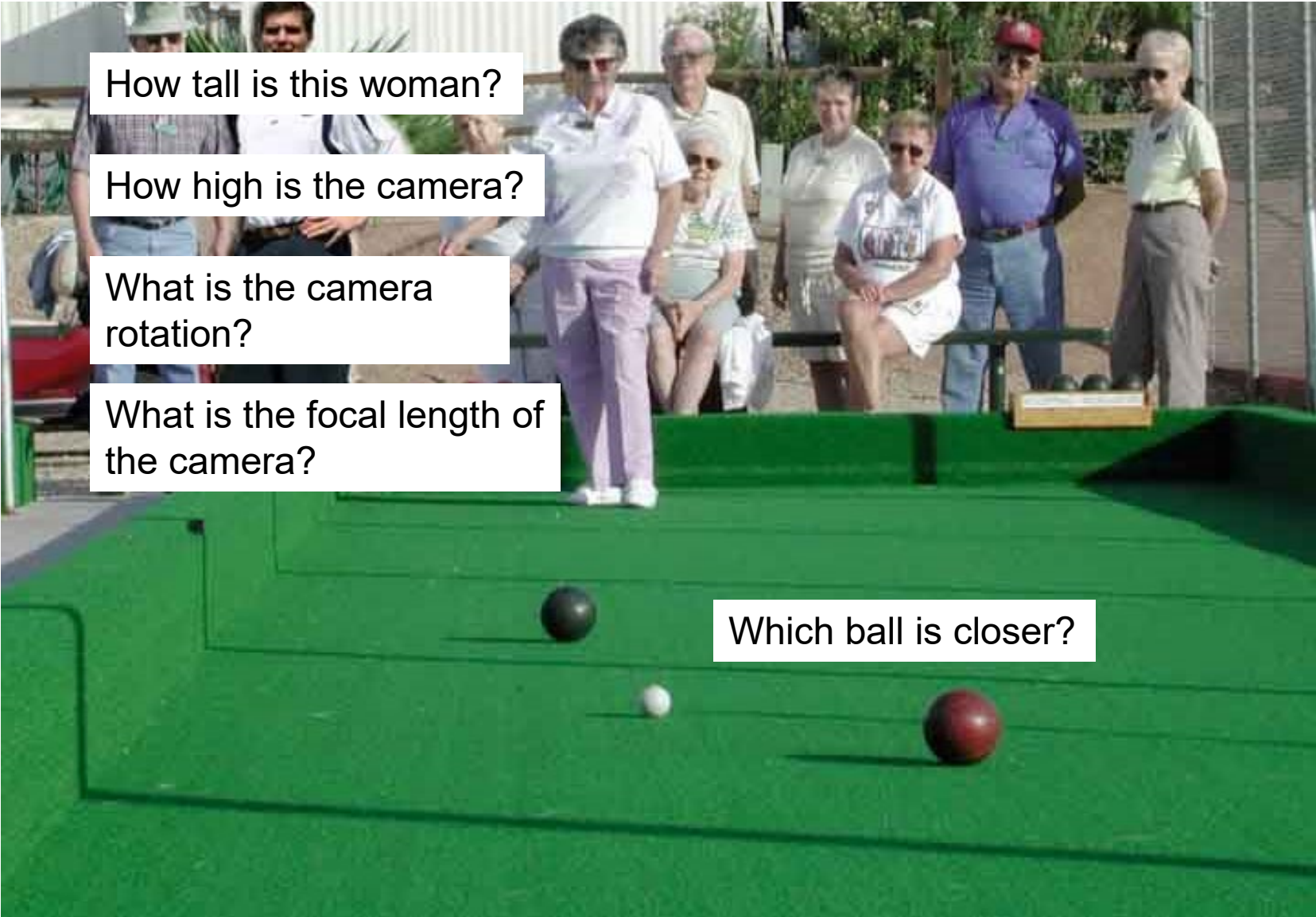

How tall is this woman?

How high is the camera?

What is the camera rotation?

What is the focal length of the camera?

Which ball is closer?

Today's lecture

Mapping between image and world coordinates

- Pinhole camera model
- Projective geometry
 - Vanishing points and lines
- Projection matrix

Image formation

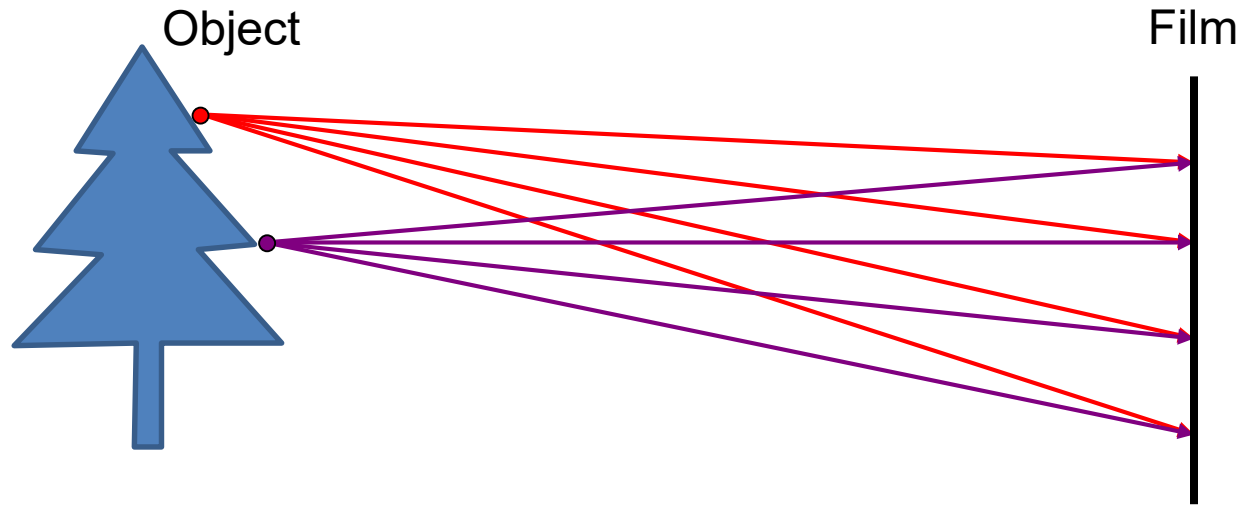

Let's design a camera

- Idea 1: put a piece of film in front of an object
- What will the image look like?

Pinhole camera

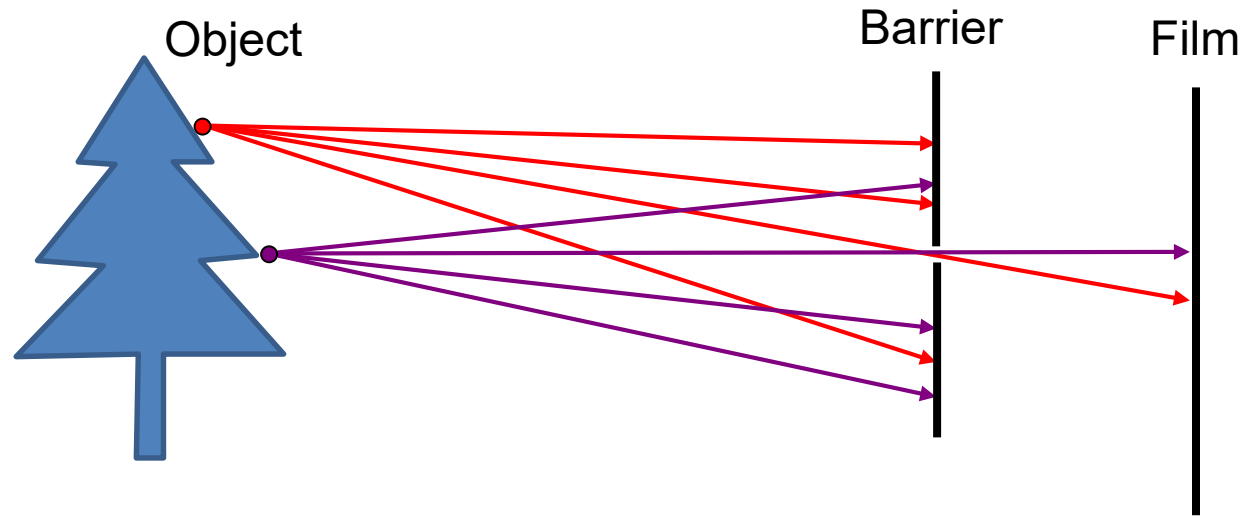

- Idea 2: add a barrier to block off most of the rays
- Few rays from a point reach the film (small blur)
 - The opening is called the **aperture**

Pinhole camera

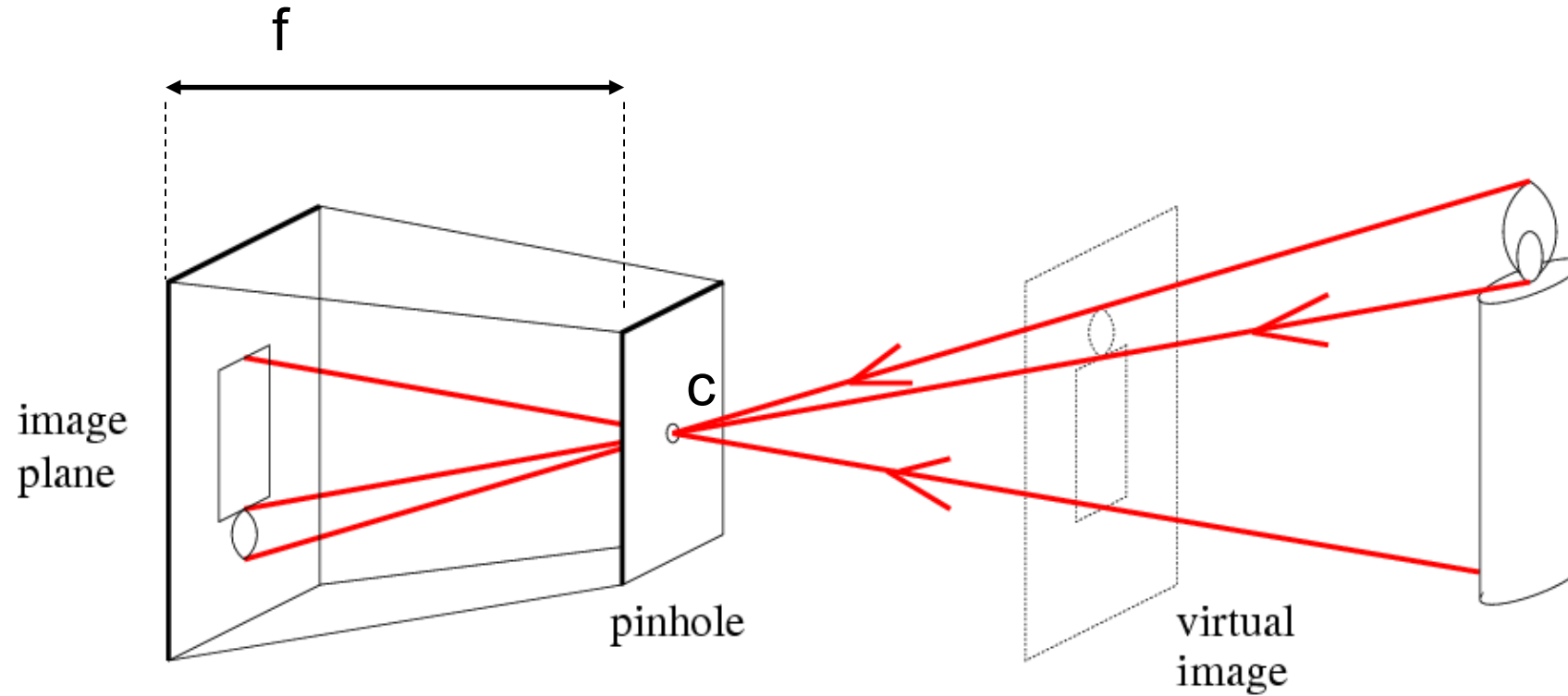

f = focal length
 c = center of the camera

Camera obscura: the pre-camera

- First idea: Mozi, China (470BC to 390BC)
- First built: Alhacen, Iraq/Egypt (965 to 1039AD)

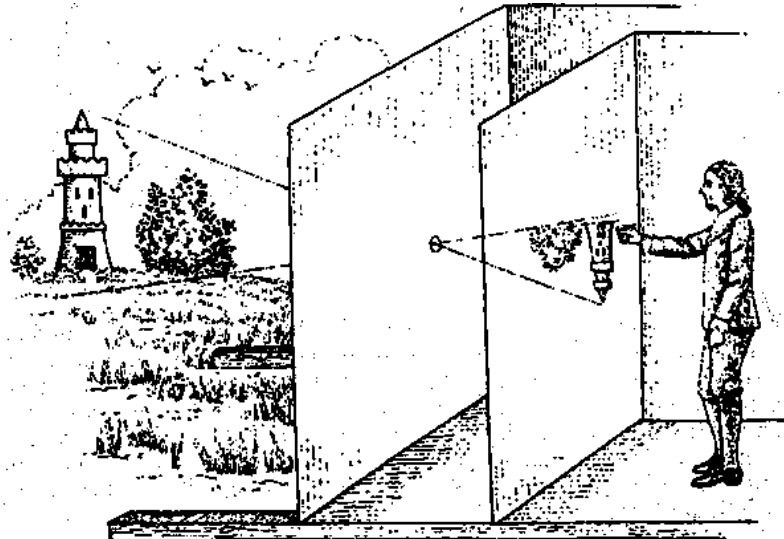
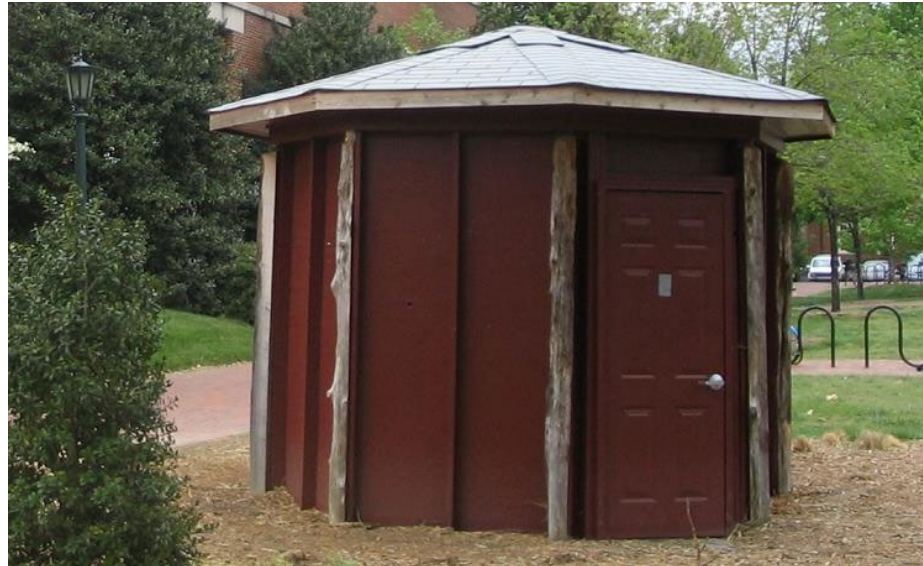

Illustration of Camera Obscura



Freestanding camera obscura at UNC Chapel Hill

Photo by Seth Ilys

Camera Obscura used for Tracing

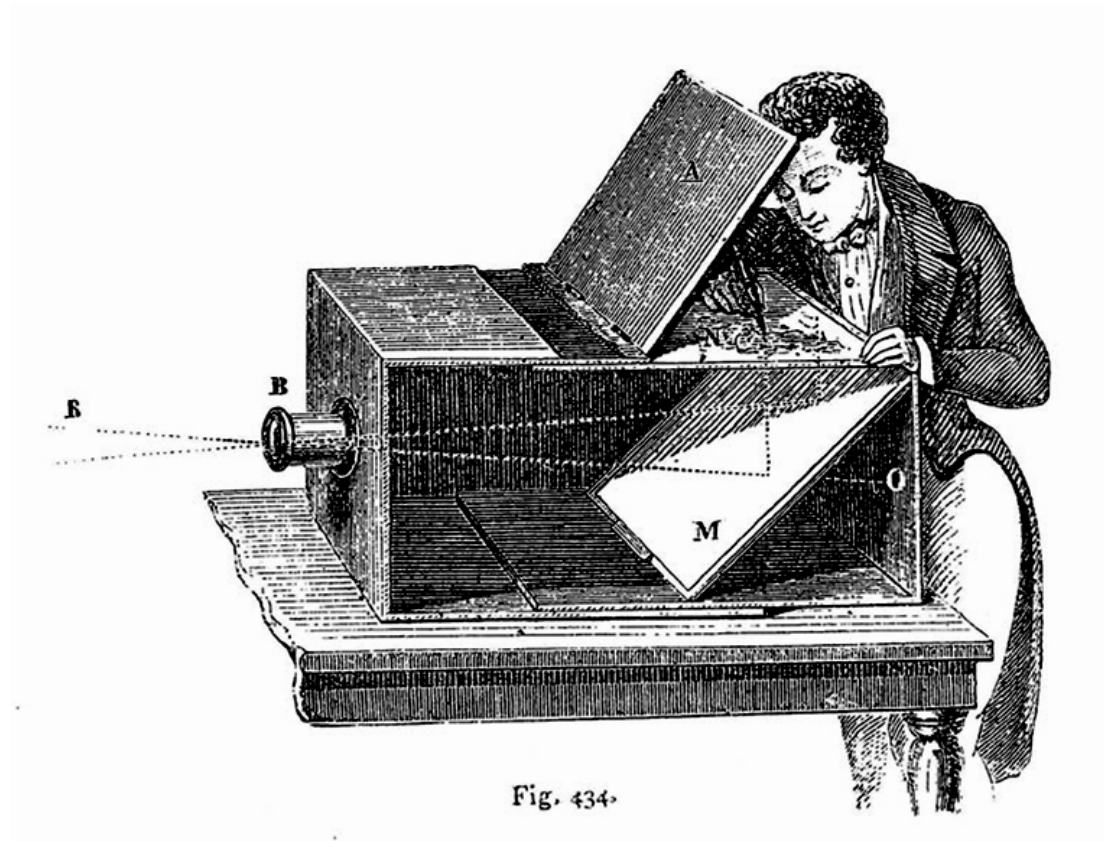

Lens Based Camera Obscura, 1568

First Photograph

Oldest surviving photograph
– Took 8 hours on pewter plate



Joseph Niepce, 1826

Photograph of the first photograph



Stored at UT Austin

Niepce later teamed up with Daguerre, who eventually created Daguerrotypes

Dimensionality Reduction Machine (3D to 2D)

3D world

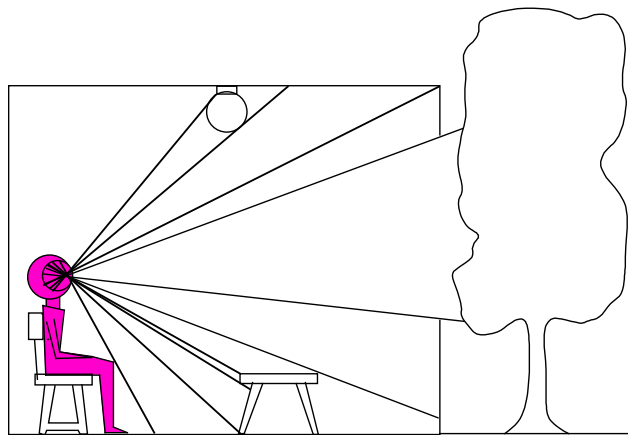

Point of observation

2D image

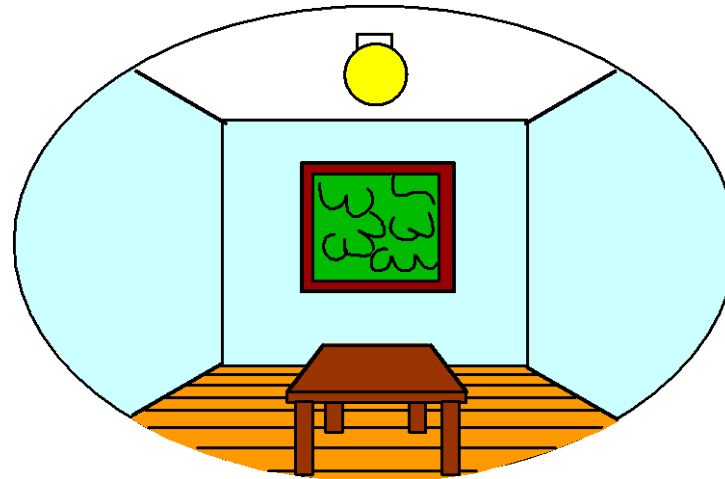

Projection can be tricky...





Projective Geometry

What is lost?

- Length

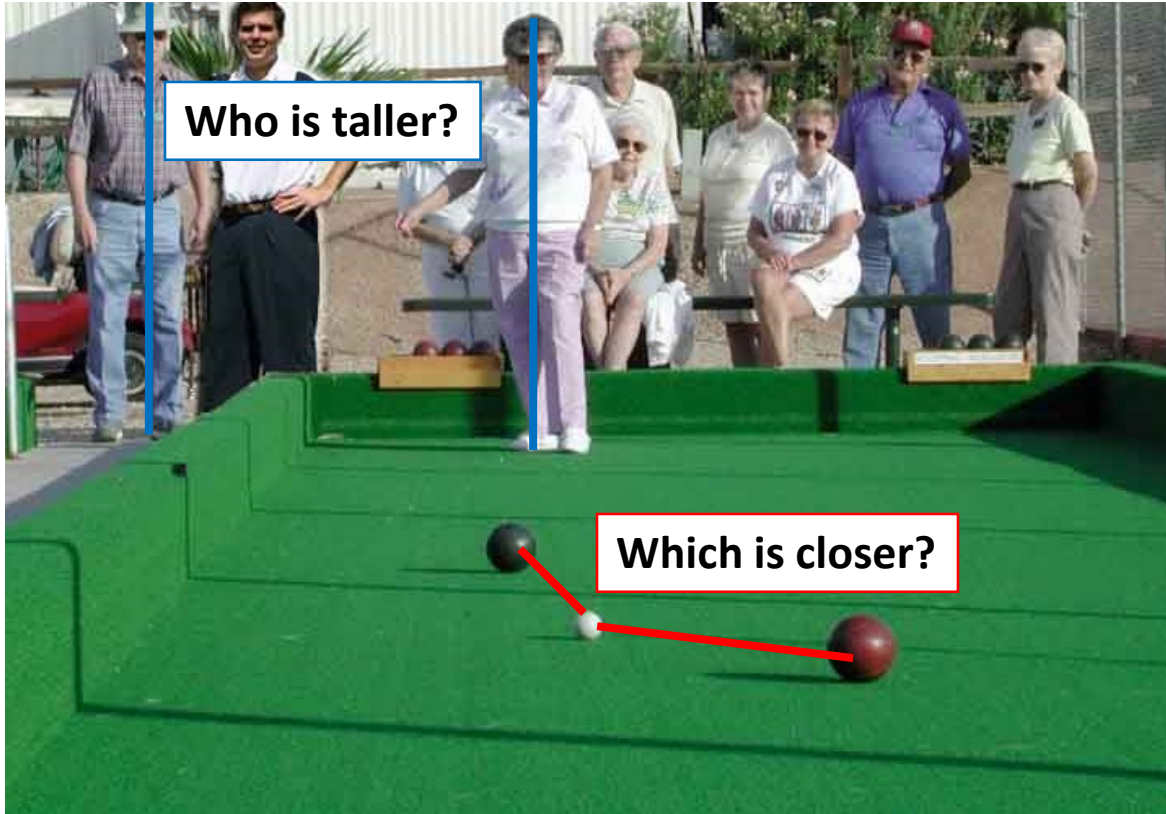

Length is not preserved

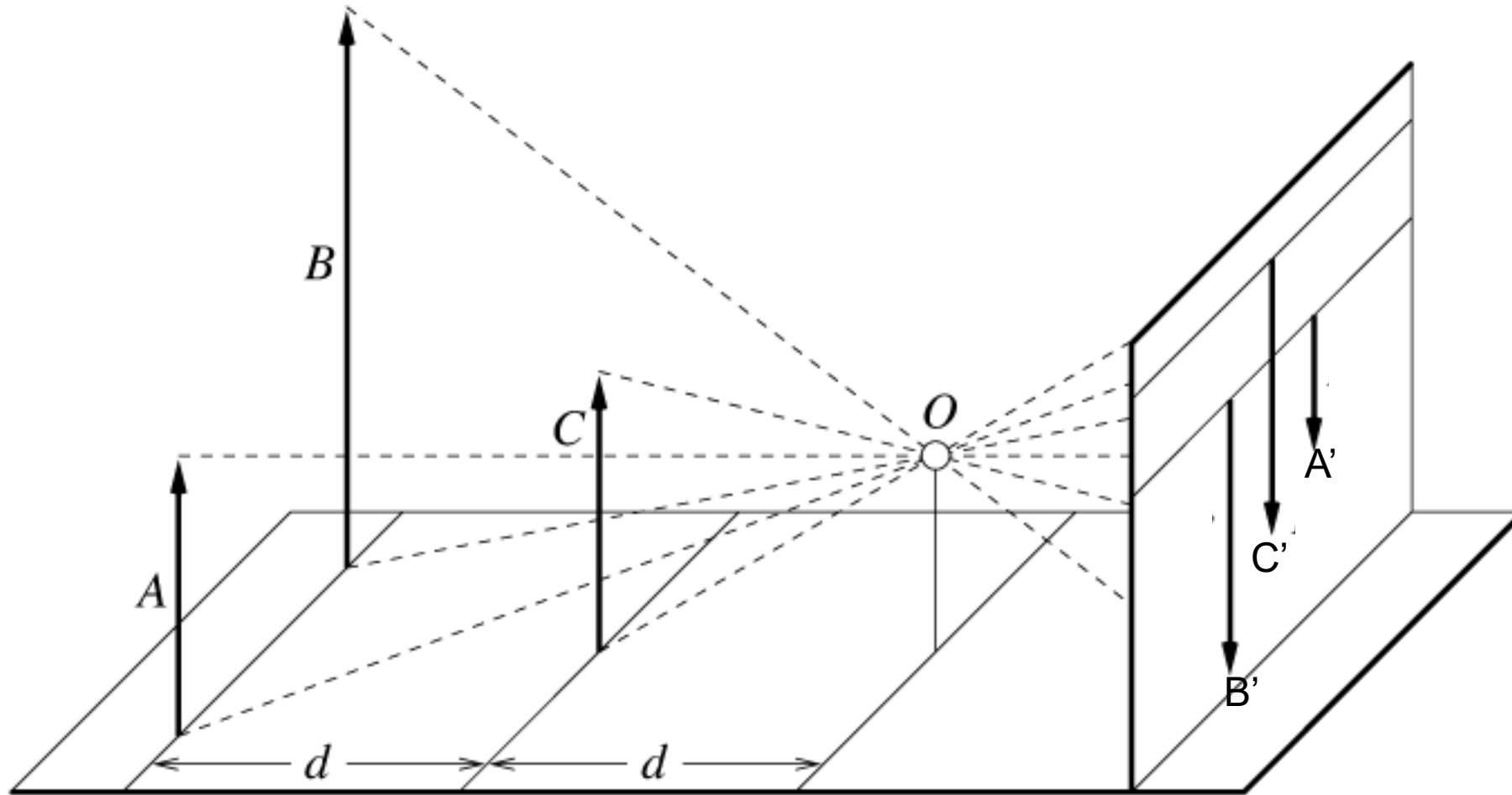
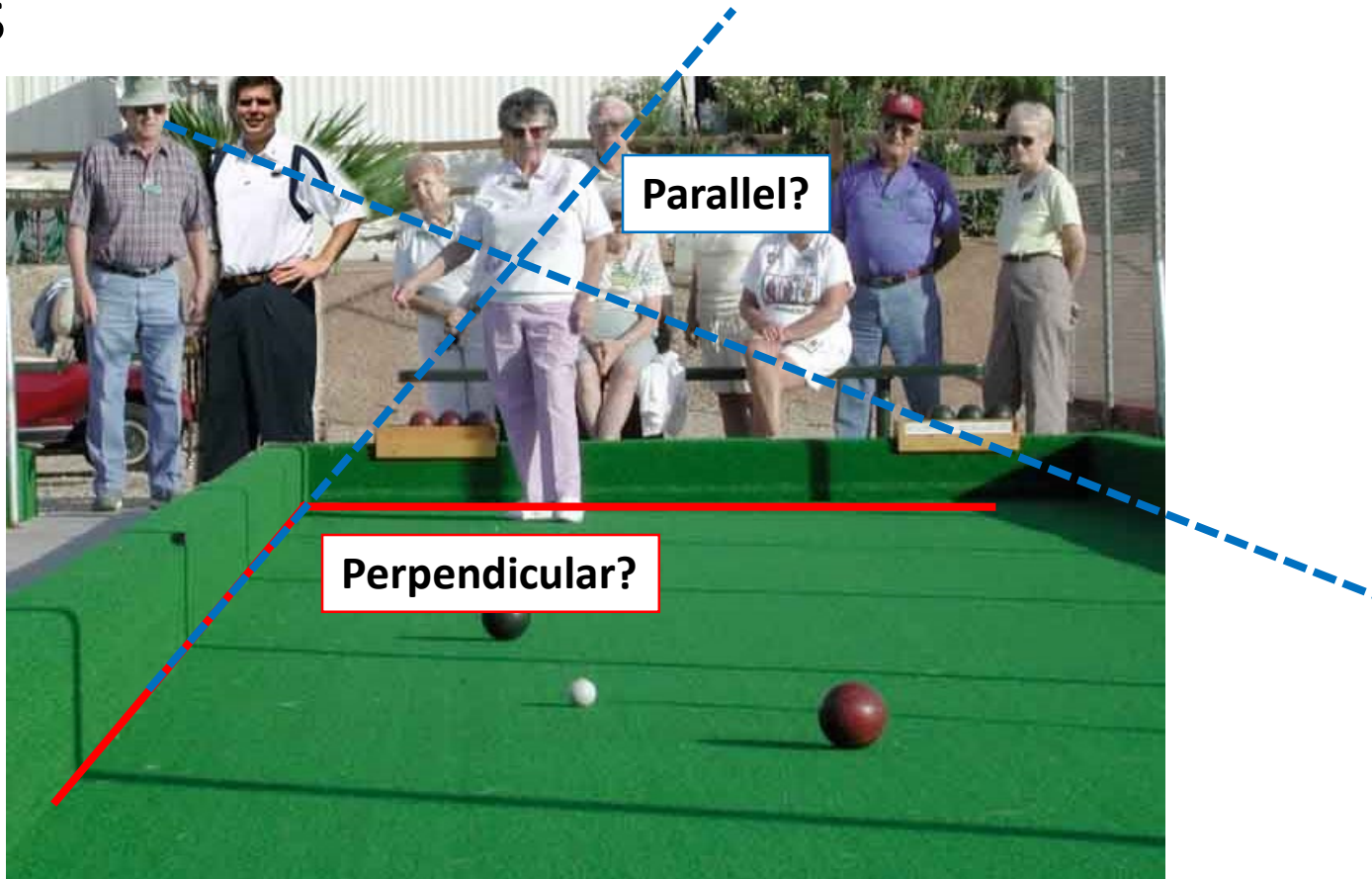

Figure by David Forsyth

Projective Geometry

What is lost?

- Length
- Angles



Projective Geometry

What is preserved?

- Straight lines are still straight

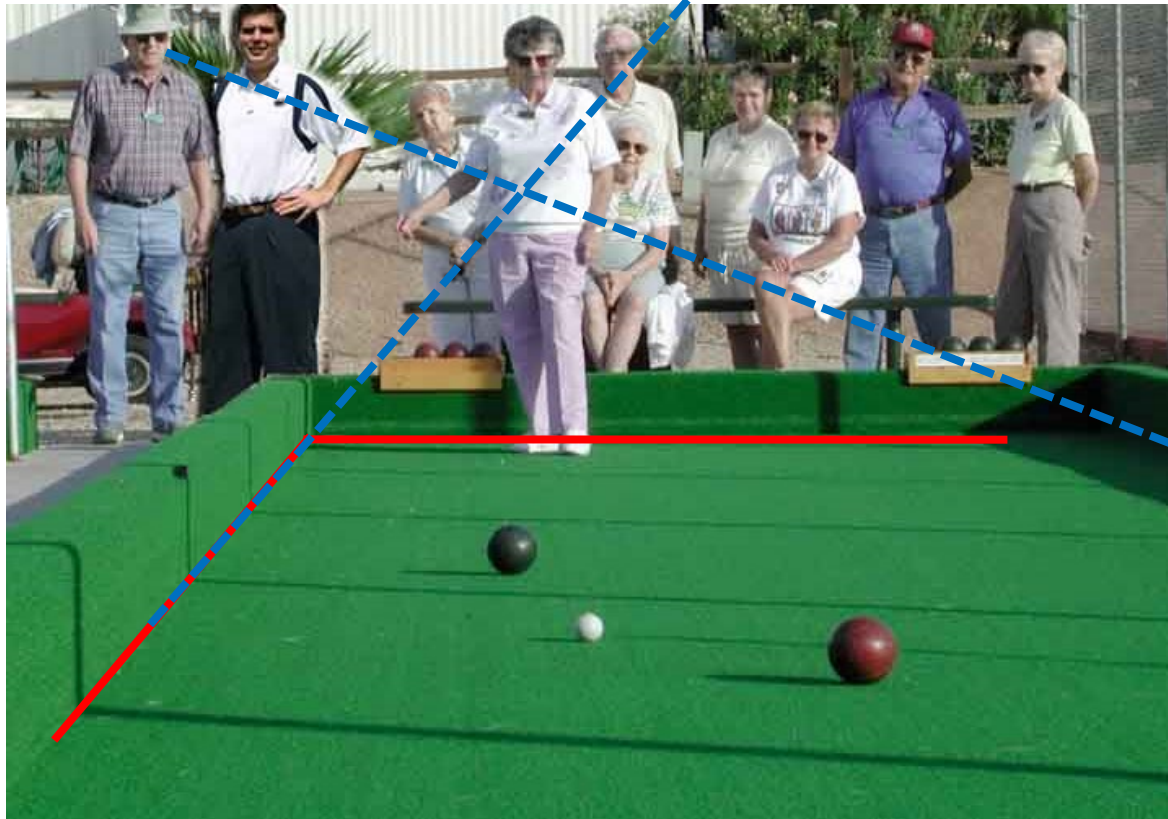

Vanishing points and lines

Parallel lines in the world intersect in the image at a “vanishing point”



Vanishing points and lines

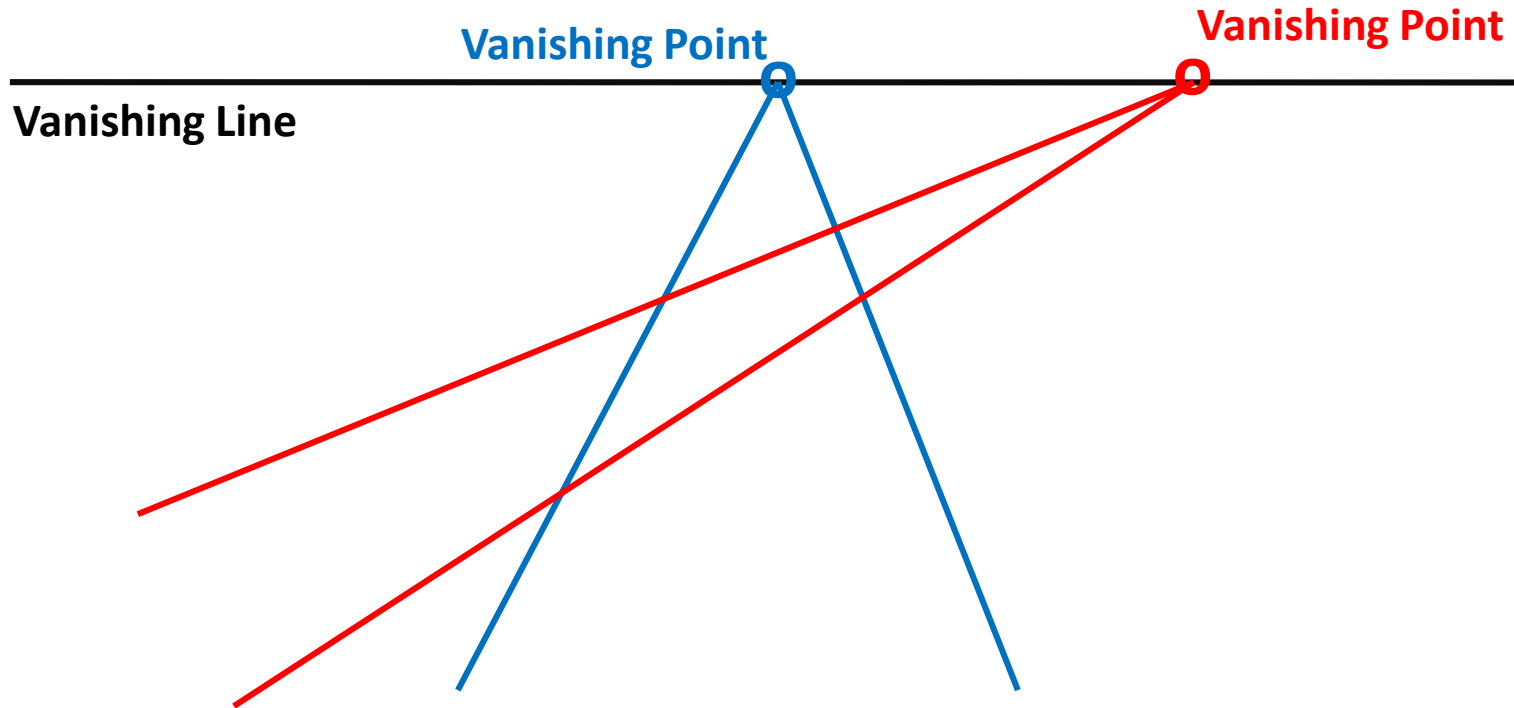

- The projections of parallel 3D lines intersect at a **vanishing point**
- The projection of parallel 3D planes intersect at a **vanishing line**
- If a set of parallel 3D lines are also parallel to a particular plane, their vanishing point will lie on the vanishing line of the plane
- Not all lines that intersect are parallel
- Vanishing point \leftrightarrow 3D direction of a line
- Vanishing line \leftrightarrow 3D orientation of a surface

Vanishing points and lines

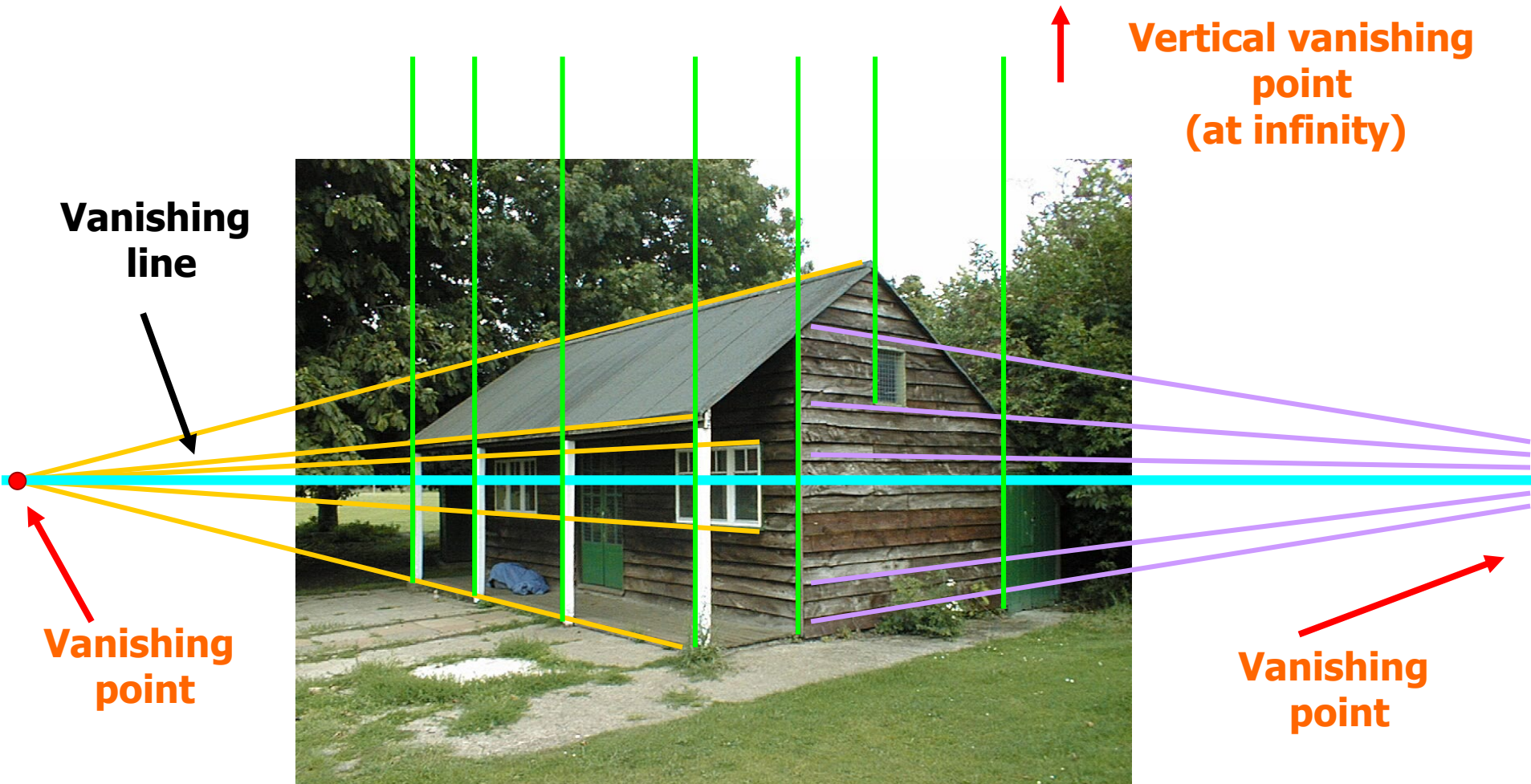

Vanishing points and lines

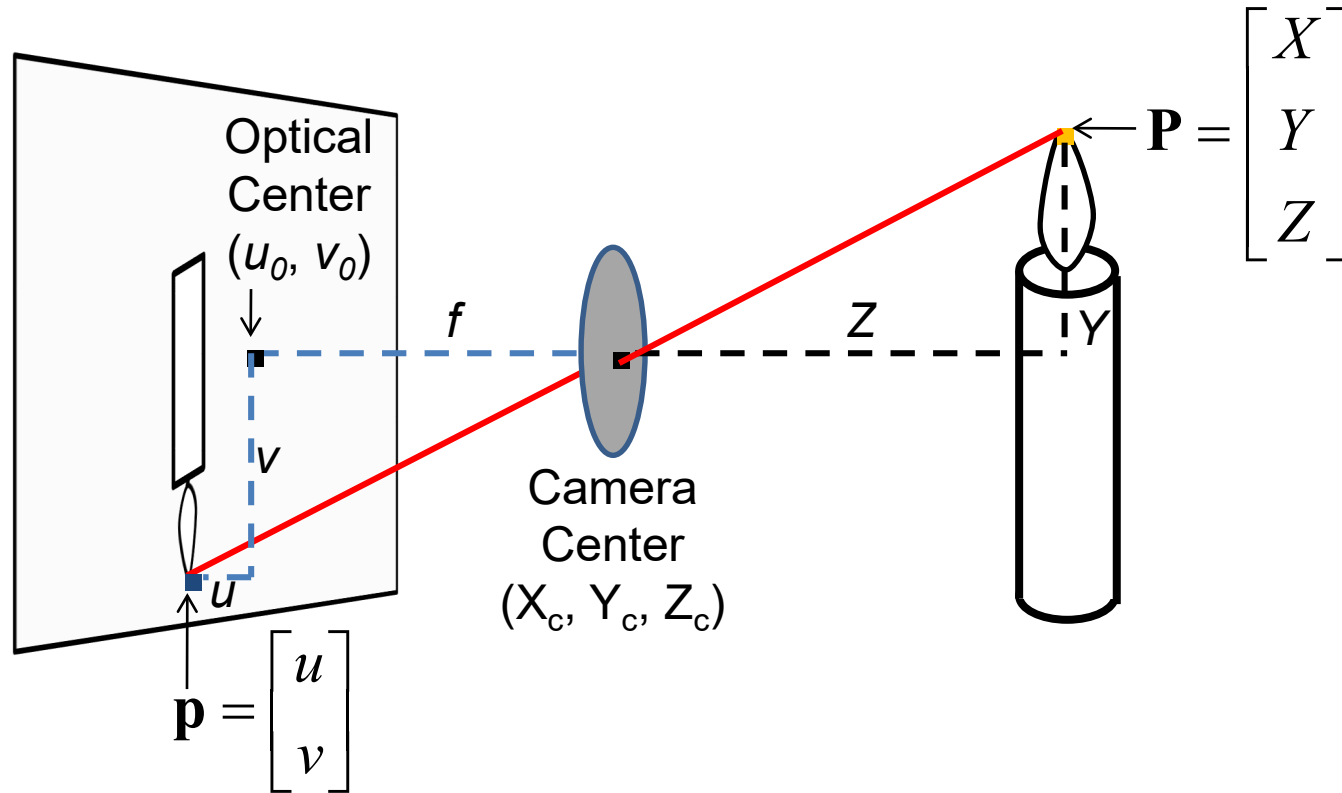

Photo from Garry Knight

Vanishing objects



Projection: world coordinates \rightarrow image coordinates



Homogeneous coordinates

Conversion

Converting to *homogeneous* coordinates

$$(x, y) \Rightarrow \begin{bmatrix} x \\ y \\ 1 \end{bmatrix}$$

homogeneous image
coordinates

$$(x, y, z) \Rightarrow \begin{bmatrix} x \\ y \\ z \\ 1 \end{bmatrix}$$

homogeneous scene
coordinates

Converting *from* homogeneous coordinates

$$\begin{bmatrix} x \\ y \\ w \end{bmatrix} \Rightarrow (x/w, y/w)$$

$$\begin{bmatrix} x \\ y \\ z \\ w \end{bmatrix} \Rightarrow (x/w, y/w, z/w)$$

Homogeneous coordinates

Invariant to scaling

$$k \begin{bmatrix} x \\ y \\ w \end{bmatrix} = \begin{bmatrix} kx \\ ky \\ kw \end{bmatrix} \Rightarrow \begin{bmatrix} \frac{kx}{kw} \\ \frac{ky}{kw} \\ \frac{kw}{kw} \end{bmatrix} = \begin{bmatrix} \frac{x}{w} \\ \frac{y}{w} \\ 1 \end{bmatrix}$$

Homogeneous Coordinates Cartesian Coordinates

Point in Cartesian is ray in Homogeneous

Basic geometry in homogeneous coordinates

- Line equation: $ax + by + c = 0$

$$line_i = \begin{bmatrix} a_i \\ b_i \\ c_i \end{bmatrix}$$

- Append 1 to pixel coordinate to get homogeneous coordinate

$$p_i = \begin{bmatrix} u_i \\ v_i \\ 1 \end{bmatrix}$$

- Line given by cross product of two points

$$line_{ij} = p_i \times p_j$$

- Intersection of two lines given by cross product of the lines

$$q_{ij} = line_i \times line_j$$

Another problem solved by homogeneous coordinates

Intersection of parallel lines

Cartesian: (Inf, Inf)
Homogeneous: $(1, 1, 0)$

Cartesian: (Inf, Inf)
Homogeneous: $(1, 2, 0)$

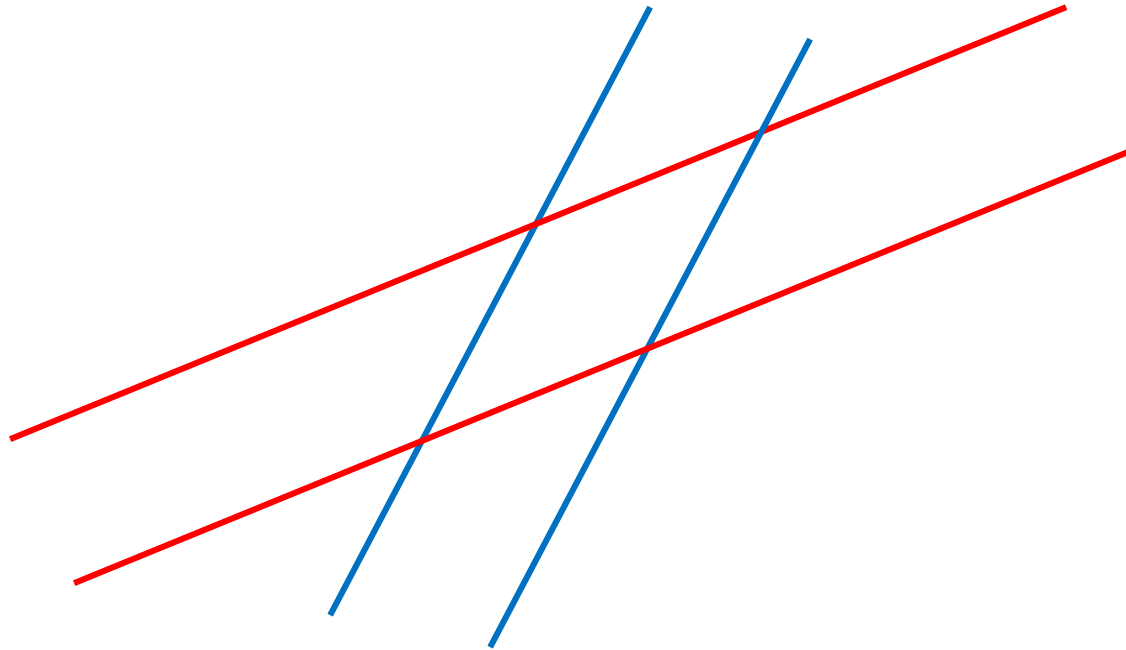

Pinhole Camera Model

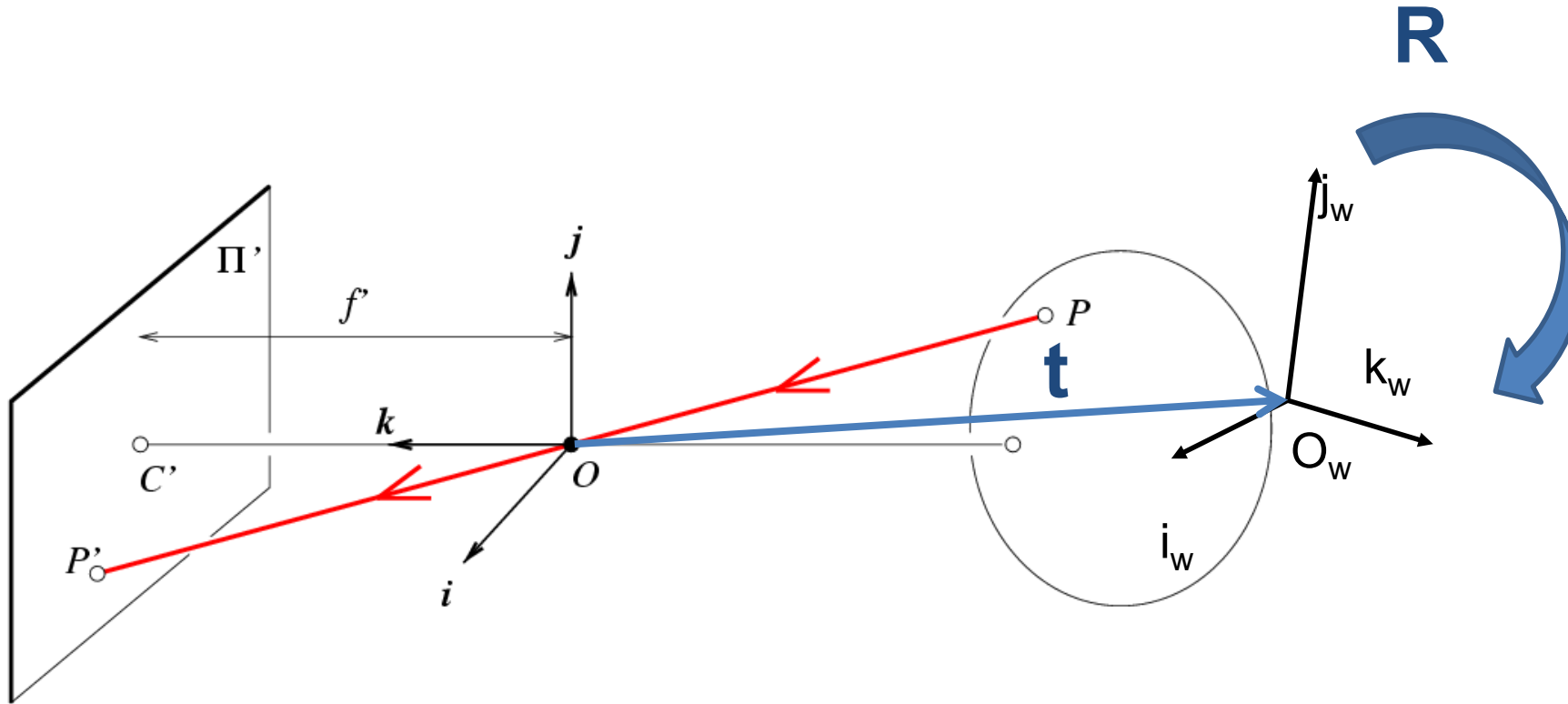

$$\mathbf{x} = \mathbf{K} \begin{bmatrix} \mathbf{R} & \mathbf{t} \end{bmatrix} \mathbf{X}$$

\mathbf{x} : Image Coordinates: $(u, v, 1)$

\mathbf{K} : Intrinsic Matrix (3×3)

\mathbf{R} : Rotation (3×3)

\mathbf{t} : Translation (3×1)

\mathbf{X} : World Coordinates: $(X, Y, Z, 1)$

Interlude: when have I used this stuff?

When have I used this stuff?

Object Recognition (CVPR 2006)



When have I used this stuff?

Single-view reconstruction (SIGGRAPH 2005)



When have I used this stuff?

Getting spatial layout in indoor scenes (ICCV 2009)

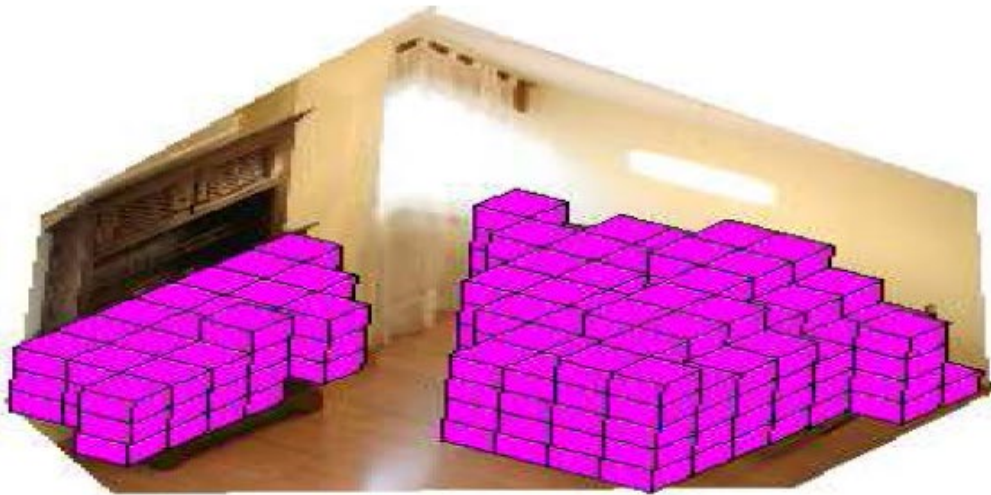
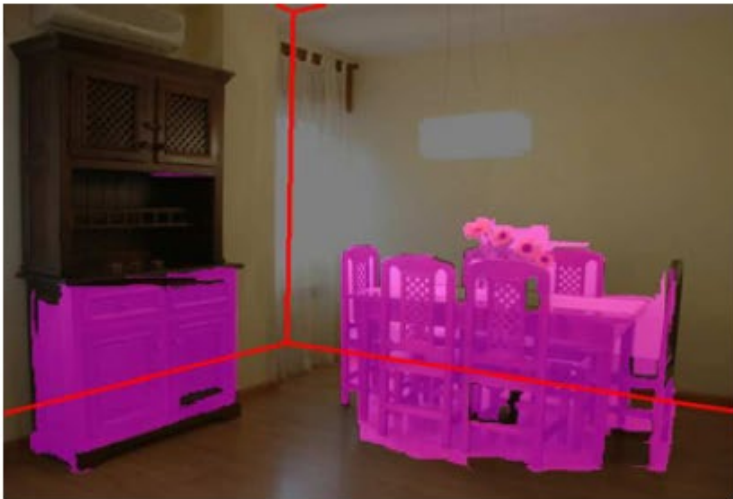

When have I used this stuff?

Inserting synthetic objects into images: <http://vimeo.com/28962540>



When have I used this stuff?

Creating detailed and complete 3D scene models from a single view

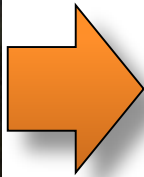
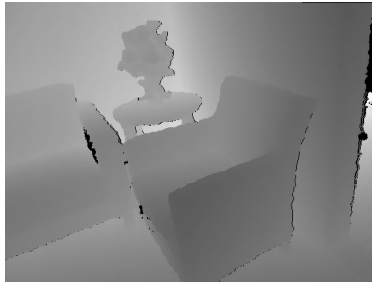

When have I used this stuff?

Multiview 3D reconstruction at Reconstruct

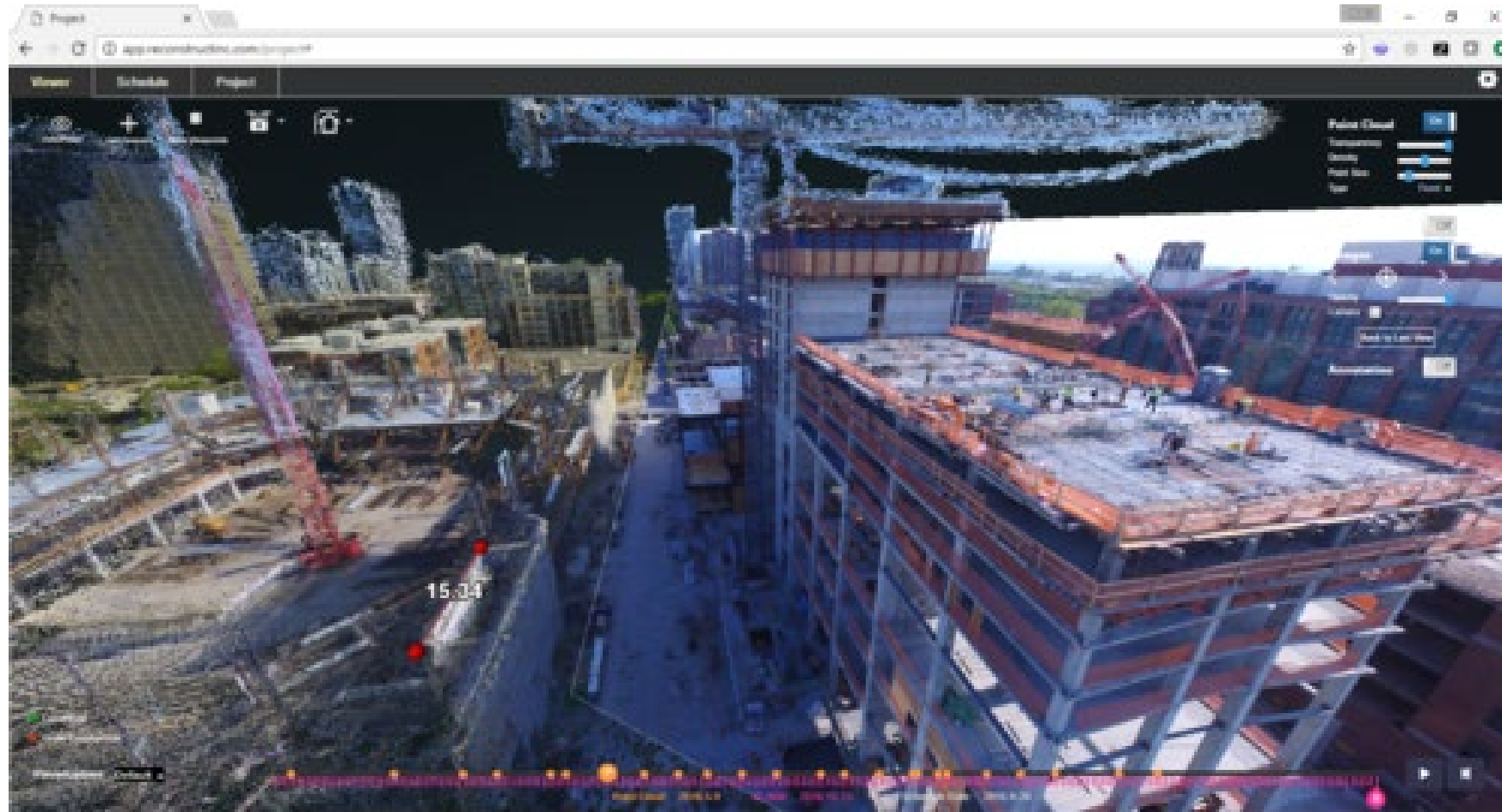

Projection matrix

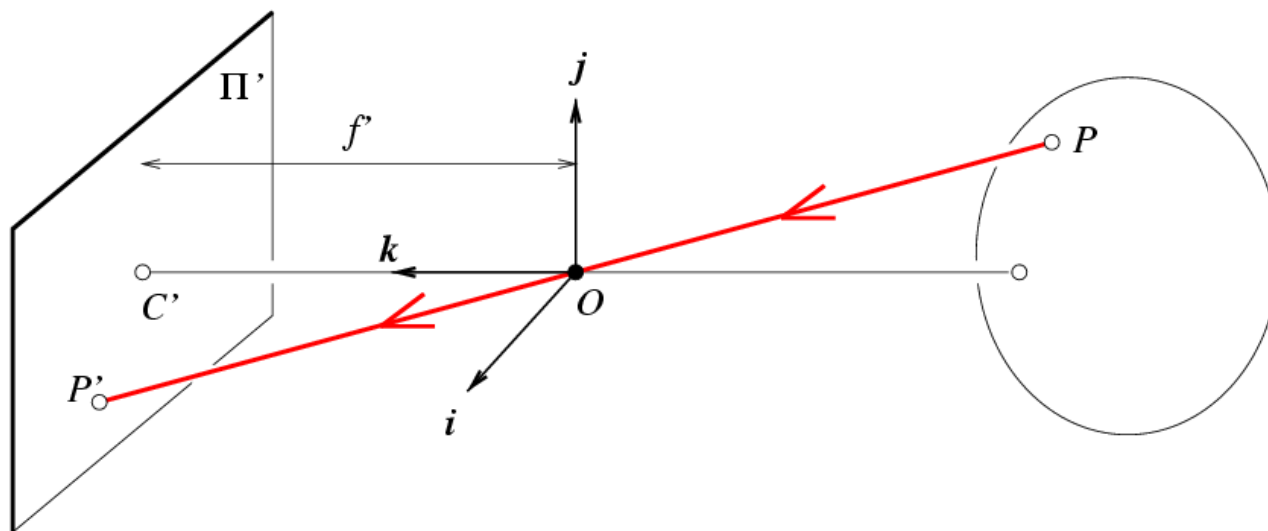

Intrinsic Assumptions

- Unit aspect ratio
- Principal point at $(0,0)$
- No skew

Extrinsic Assumptions

- No rotation
- Camera at $(0,0,0)$

$$\mathbf{x} = \mathbf{K} \begin{bmatrix} \mathbf{I} & \mathbf{0} \end{bmatrix} \mathbf{X} \Rightarrow w \begin{bmatrix} u \\ v \\ 1 \end{bmatrix} = \begin{bmatrix} f & 0 & 0 \\ 0 & f & 0 \\ 0 & 0 & 1 \end{bmatrix} \begin{bmatrix} x \\ y \\ z \\ 1 \end{bmatrix}$$

K

Remove assumption about principal point

Intrinsic Assumptions

- Unit aspect ratio
- No skew

Extrinsic Assumptions

- No rotation
- Camera at (0,0,0)

$$\mathbf{x} = \mathbf{K} \begin{bmatrix} \mathbf{I} & \mathbf{0} \end{bmatrix} \mathbf{X} \Rightarrow w \begin{bmatrix} u \\ v \\ 1 \end{bmatrix} = \begin{bmatrix} f & 0 & u_0 \\ 0 & f & v_0 \\ 0 & 0 & 1 \end{bmatrix} \begin{bmatrix} x \\ y \\ z \\ 1 \end{bmatrix}$$

This is a very commonly used model

Remove assumption that pixels are square

Intrinsic Assumptions

- No skew

Extrinsic Assumptions

- No rotation
- Camera at (0,0,0)

$$\mathbf{x} = \mathbf{K} \begin{bmatrix} \mathbf{I} & \mathbf{0} \end{bmatrix} \mathbf{X} \rightarrow w \begin{bmatrix} u \\ v \\ 1 \end{bmatrix} = \begin{bmatrix} \alpha & 0 & u_0 \\ 0 & \beta & v_0 \\ 0 & 0 & 1 \end{bmatrix} \begin{bmatrix} x \\ y \\ z \\ 1 \end{bmatrix}$$

Remove assumption that pixels are not skewed

Intrinsic Assumptions Extrinsic Assumptions

- No rotation
- Camera at (0,0,0)

$$\mathbf{x} = \mathbf{K} \begin{bmatrix} \mathbf{I} & \mathbf{0} \end{bmatrix} \mathbf{X} \rightarrow w \begin{bmatrix} u \\ v \\ 1 \end{bmatrix} = \begin{bmatrix} \alpha & s & u_0 \\ 0 & \beta & v_0 \\ 0 & 0 & 1 \end{bmatrix} \begin{bmatrix} x \\ y \\ z \\ 1 \end{bmatrix}$$

Note: different books use different notation for parameters

Oriented and Translated Camera

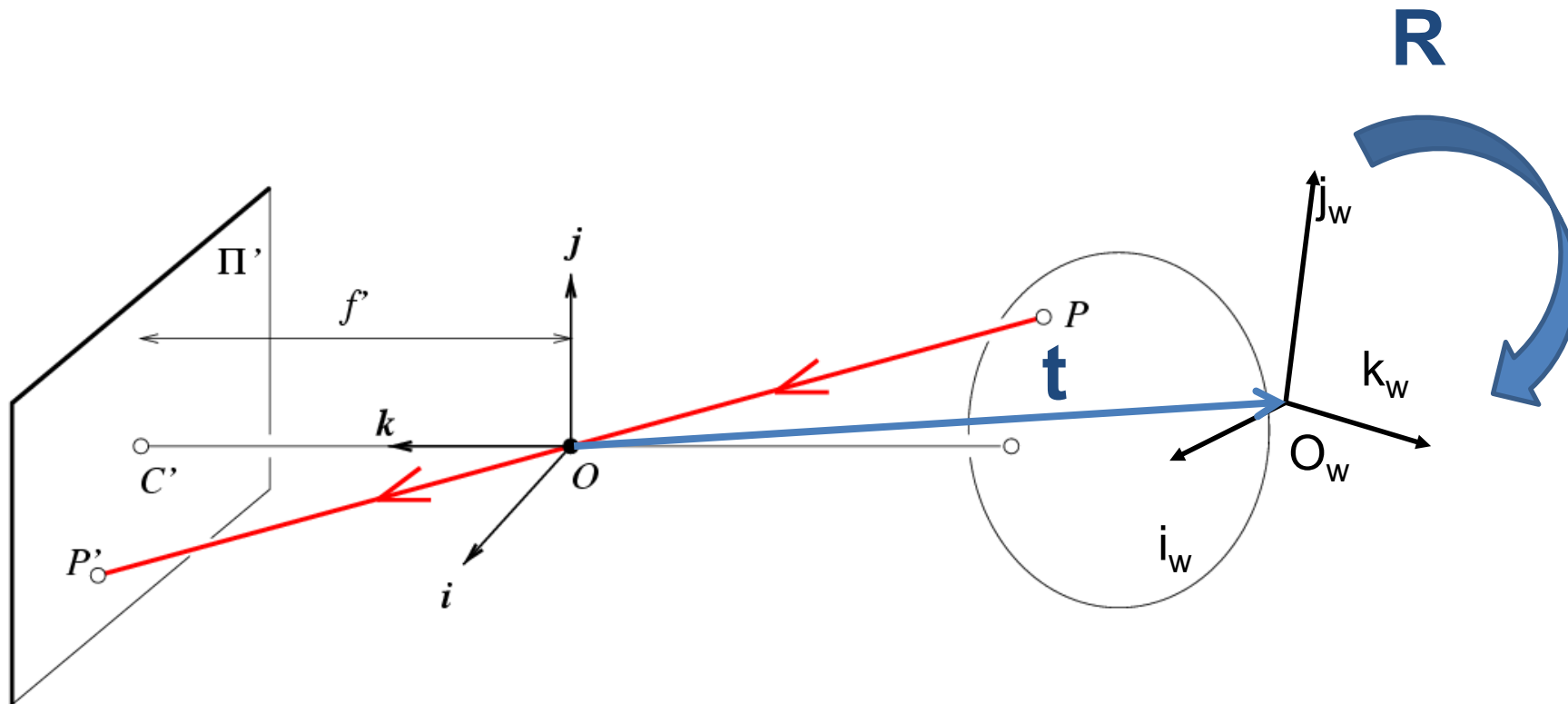

Allow camera translation

Intrinsic Assumptions Extrinsic Assumptions

- No rotation

$$\mathbf{x} = \mathbf{K} \begin{bmatrix} \mathbf{I} & \mathbf{t} \end{bmatrix} \mathbf{X} \quad \Rightarrow \quad w \begin{bmatrix} u \\ v \\ 1 \end{bmatrix} = \begin{bmatrix} \alpha & 0 & u_0 \\ 0 & \beta & v_0 \\ 0 & 0 & 1 \end{bmatrix} \begin{bmatrix} 1 & 0 & 0 & t_x \\ 0 & 1 & 0 & t_y \\ 0 & 0 & 1 & t_z \end{bmatrix} \begin{bmatrix} x \\ y \\ z \\ 1 \end{bmatrix}$$

3D Rotation of Points

Rotation around the coordinate axes, **counter-clockwise**:

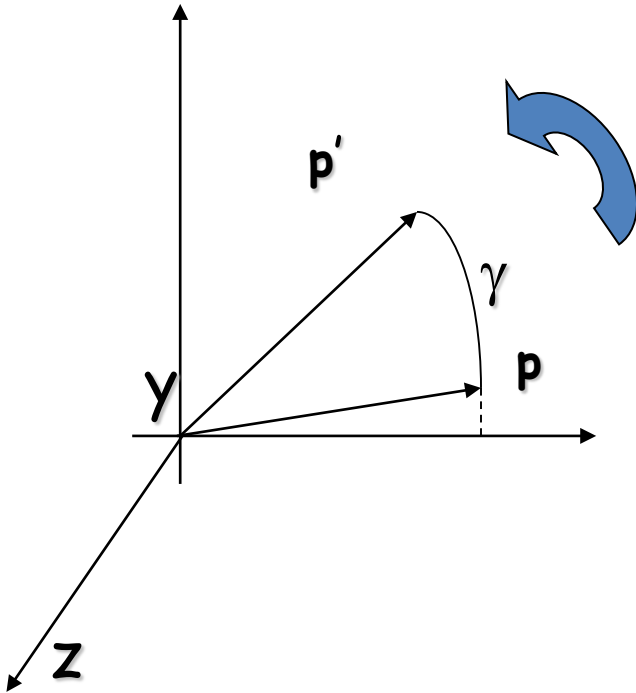

$$R_x(\alpha) = \begin{bmatrix} 1 & 0 & 0 \\ 0 & \cos \alpha & -\sin \alpha \\ 0 & \sin \alpha & \cos \alpha \end{bmatrix}$$

$$R_y(\beta) = \begin{bmatrix} \cos \beta & 0 & \sin \beta \\ 0 & 1 & 0 \\ -\sin \beta & 0 & \cos \beta \end{bmatrix}$$

$$R_z(\gamma) = \begin{bmatrix} \cos \gamma & -\sin \gamma & 0 \\ \sin \gamma & \cos \gamma & 0 \\ 0 & 0 & 1 \end{bmatrix}$$

Allow camera rotation

$$\mathbf{x} = \mathbf{K}[\mathbf{R} \quad \mathbf{t}] \mathbf{X}$$



$$w \begin{bmatrix} u \\ v \\ 1 \end{bmatrix} = \begin{bmatrix} \alpha & s & u_0 \\ 0 & \beta & v_0 \\ 0 & 0 & 1 \end{bmatrix} \begin{bmatrix} r_{11} & r_{12} & r_{13} & t_x \\ r_{21} & r_{22} & r_{23} & t_y \\ r_{31} & r_{32} & r_{33} & t_z \end{bmatrix} \begin{bmatrix} x \\ y \\ z \\ 1 \end{bmatrix}$$

Degrees of freedom

$$\mathbf{x} = \mathbf{K} \begin{bmatrix} \mathbf{R} & \mathbf{t} \end{bmatrix} \mathbf{X}$$



$$w \begin{bmatrix} u \\ v \\ 1 \end{bmatrix} = \begin{matrix} 5 \\ \begin{bmatrix} \alpha & s & u_0 \\ 0 & \beta & v_0 \\ 0 & 0 & 1 \end{bmatrix} \end{matrix} \begin{matrix} 6 \\ \begin{bmatrix} r_{11} & r_{12} & r_{13} \\ r_{21} & r_{22} & r_{23} \\ r_{31} & r_{32} & r_{33} \end{bmatrix} \end{matrix} \begin{bmatrix} t_x \\ t_y \\ t_z \end{bmatrix} \begin{bmatrix} x \\ y \\ z \\ 1 \end{bmatrix}$$

Vanishing Point = Projection from Infinity

$$\mathbf{p} = \mathbf{K}[\mathbf{R} \quad \mathbf{t}] \begin{bmatrix} x \\ y \\ z \\ 0 \end{bmatrix} \Rightarrow \mathbf{p} = \mathbf{KR} \begin{bmatrix} x \\ y \\ z \end{bmatrix} \Rightarrow \mathbf{p} = \mathbf{K} \begin{bmatrix} x_R \\ y_R \\ z_R \end{bmatrix}$$

$$w \begin{bmatrix} u \\ v \\ 1 \end{bmatrix} = \begin{bmatrix} f & 0 & u_0 \\ 0 & f & v_0 \\ 0 & 0 & 1 \end{bmatrix} \begin{bmatrix} x_R \\ y_R \\ z_R \end{bmatrix} \Rightarrow \begin{aligned} u &= \frac{fx_R}{z_R} + u_0 \\ v &= \frac{fy_R}{z_R} + v_0 \end{aligned}$$

Orthographic Projection

- Special case of perspective projection
 - Distance from the center of projection to the image plane is infinite

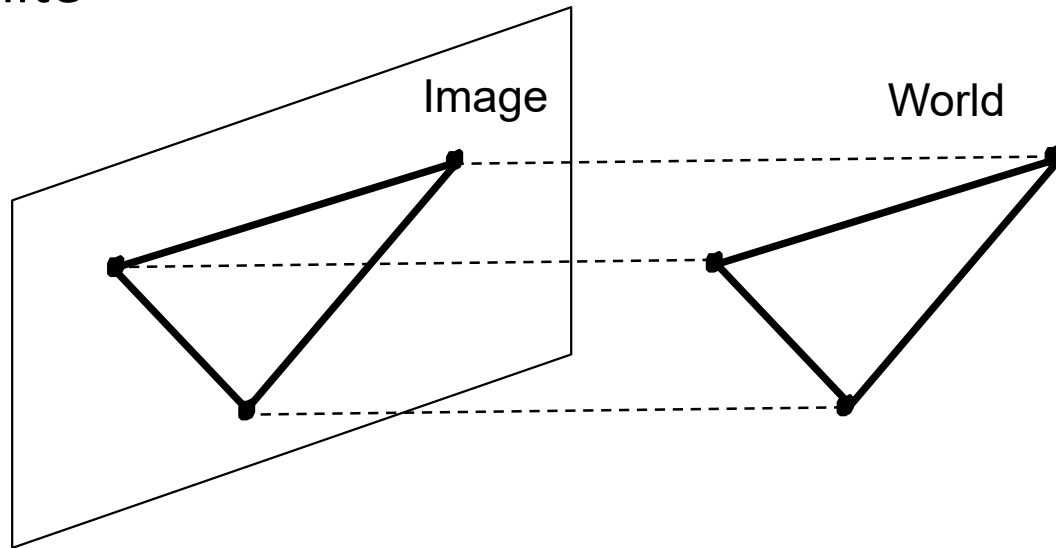

- Also called “parallel projection”
- What’s the projection matrix?

$$\begin{bmatrix} u \\ v \\ 1 \end{bmatrix} = \begin{bmatrix} 1 & 0 & 0 & u_0 \\ 0 & 1 & 0 & v_0 \\ 0 & 0 & 0 & 1 \end{bmatrix} \begin{bmatrix} x \\ y \\ z \\ 1 \end{bmatrix}$$

Scaled Orthographic Projection

- Special case of perspective projection
 - Object dimensions are small compared to distance to camera

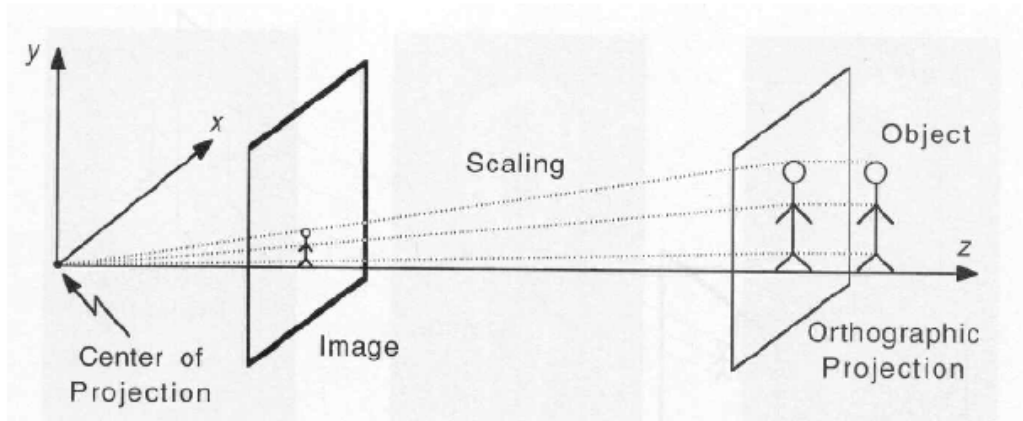

Illustration from George Bebis



Top-down ortho of building in Research Park

- Also called “weak perspective”
- What’s the projection matrix?

$$w \begin{bmatrix} u \\ v \\ 1 \end{bmatrix} = \begin{bmatrix} f & 0 & 0 & 0 \\ 0 & f & 0 & 0 \\ 0 & 0 & 0 & s \end{bmatrix} \begin{bmatrix} x \\ y \\ z \\ 1 \end{bmatrix}$$

pixel scale

Take-home question

Suppose we have two 3D cubes on the ground facing the viewer, one near, one far.

1. What would they look like in perspective?
2. What would they look like in weak perspective?



Take-home questions

- Suppose the camera axis is in the direction of $(x=0, y=0, z=1)$ in its own coordinate system. What is the camera axis in world coordinates given the extrinsic parameters \mathbf{R}, \mathbf{t}
- Suppose a camera at height $y=h$ ($x=0, z=0$) observes a point at (u, v) known to be on the ground ($y=0$). Assume R is identity. What is the 3D position of the point in terms of f, u_0, v_0 ?

Beyond Pinholes: Radial Distortion

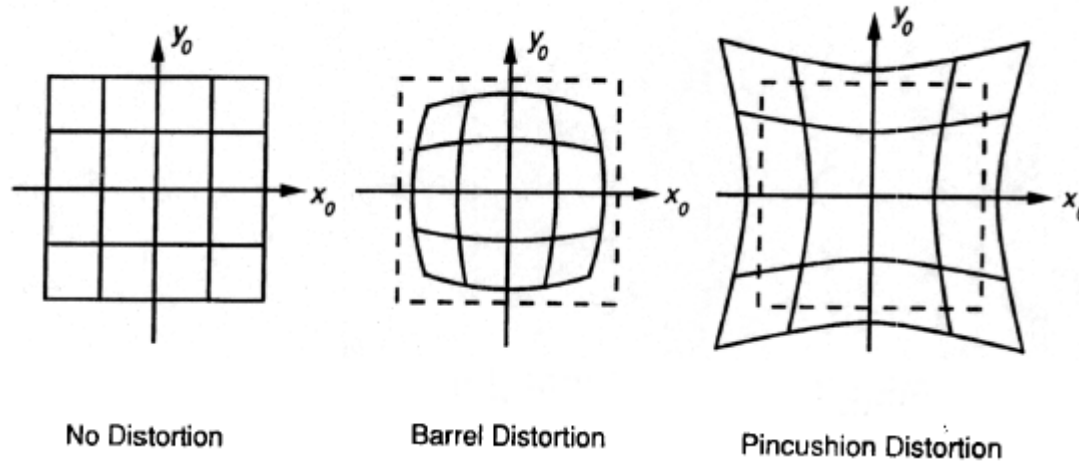

Corrected Barrel Distortion

Things to remember

- Vanishing points and vanishing lines

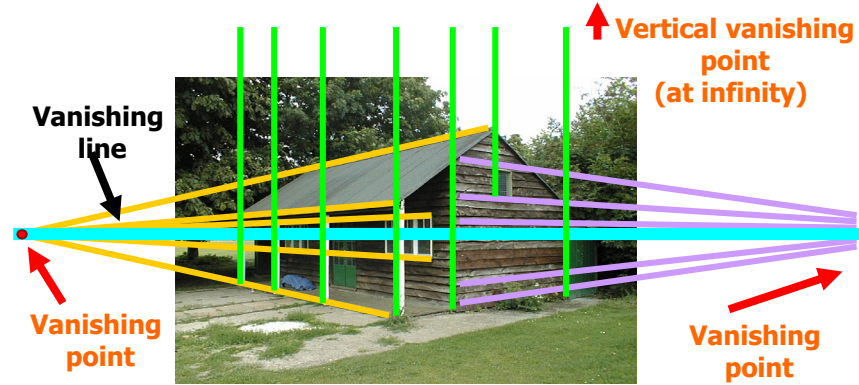

- Pinhole camera model and camera projection matrix

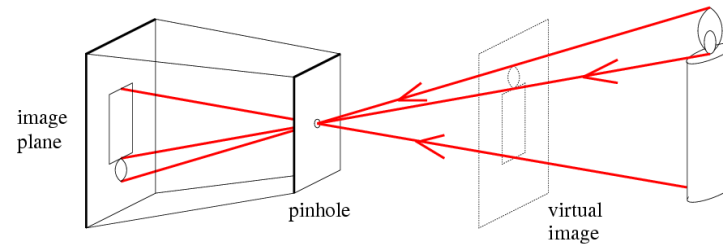

$$\mathbf{x} = \mathbf{K}[\mathbf{R} \quad \mathbf{t}] \mathbf{X}$$

Next lectures

- Single-view metrology and more camera model
 - Measuring 3D distances from the image
 - Effects of lens, aperture, focal length, sensor size
- Single-view 3D reconstruction