

[[I]n his short and broken treatise he provides an eternal example—not of laws, or even of method, for there is no method except to be very intelligent, but of intelligence itself swiftly operating the analysis of sensation to the point of principle and definition.

— T. S. Eliot on Aristotle, “The Perfect Critic”, *The Sacred Wood* (1921)

The nice thing about standards is that you have so many to choose from; furthermore, if you do not like any of them, you can just wait for next year’s model.

— Andrew S. Tannenbaum, *Computer Networks* (1981)

Also attributed to Grace Murray Hopper and others

If a problem has no solution, it may not be a problem, but a fact — not to be solved, but to be coped with over time.

— Shimon Peres, as quoted by David Rumsfeld, *Rumsfeld’s Rules* (2001)

CHAPTER 10

NP-Hardness

10.1 A Game You Can’t Win

Imagine that a salesman in a red suit, who looks suspiciously like Tom Waits, presents you with a black steel box with n binary switches on the front and a light bulb on the top. The salesman tells you that the state of the light bulb is controlled by a complex *boolean circuit*—a collection of AND, OR, and NOT gates connected by wires, with one input wire for each switch and a single output wire for the light bulb. He then asks you the following question: Is there a way to set the switches so that the light bulb turns on? If you can answer this question correctly, he will give you the box and a ~~million billion~~ trillion dollars; if you answer incorrectly, or if you die without answering at all, he will take your soul.

As far as you can tell, the Adversary hasn’t connected the switches to the light bulb at all, so no matter how you set the switches, the light bulb will stay off. If you declare that it is possible to turn on the light, the Adversary will open the box and reveal that there is no circuit at all. But if you declare that it is *not* possible to turn on the light, before testing all 2^n settings, the Adversary will magically create a circuit inside the box that turns on the light *if and only if* the switches are in one of the settings you haven’t

© Copyright 2016 Jeff Erickson.

This work is licensed under a Creative Commons License (<http://creativecommons.org/licenses/by-nc-sa/4.0/>).

Free distribution is strongly encouraged; commercial distribution is expressly forbidden.

See <http://jeffe.cs.illinois.edu/teaching/algorithms/> for the most recent revision.

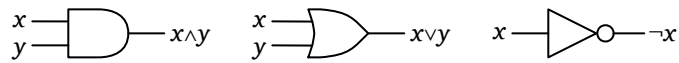

Figure 10.1. An AND gate, an OR gate, and a NOT gate.

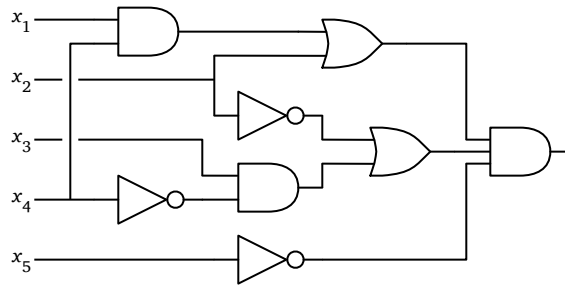

Figure 10.2. A boolean circuit. Inputs enter from the left, and the output leaves to the right.

tested, and then flip the switches to that setting, turning on the light. (You can't detect the Adversary's cheating, because you can't see inside the box until the end.) The only way to *provably* answer the Adversary's question correctly is to try all 2^n possible settings. You quickly realize that this will take *far* longer than you expect to live, so you gracefully decline the Adversary's offer.

The Adversary smiles and says, "Ah, yes, of course, you have no reason to trust me. But perhaps I can set your mind at ease." He hands you a large roll of parchment—which you hope was made from sheep skin—with a circuit diagram drawn (or perhaps tattooed) on it. "Here are the complete plans for the circuit inside the box. Feel free to poke around inside the box to make sure the plans are correct. Or build your own circuit from these plans. Or write a computer program to simulate the circuit. Whatever you like. If you discover that the plans don't match the actual circuit in the box, you win the trillion bucks." A few spot checks convince you that the plans have no obvious flaws; subtle cheating appears to be impossible.

But you should still decline the Adversary's generous offer. The problem that the Adversary is posing is called *circuit satisfiability* or **CIRCUITSAT**: Given a boolean circuit, is there a set of inputs that makes the circuit output TRUE, or conversely, whether the circuit *always* outputs FALSE. For any *particular* input setting, we can calculate the output of the circuit in polynomial (actually, *linear*) time using depth-first-search. But nobody knows how to solve CIRCUITSAT faster than just trying all 2^n possible inputs to the circuit by brute force, which requires exponential time. Admittedly, nobody has actually formally *proved* that we can't beat brute force—maybe, just *maybe*, there's a clever algorithm that just hasn't been discovered yet—but nobody has actually formally proved that anti-gravity unicorns don't exist, either. For all practical purposes, it's safe to assume that there is no fast algorithm for CIRCUITSAT.

10.2 P versus NP

A minimal requirement for an algorithm to be considered “efficient” is that its running time is polynomial: $O(n^c)$ for some constant c , where n is the size of the input.¹ Researchers recognized early on that not all problems can be solved this quickly, but had a hard time figuring out exactly which ones could and which ones couldn’t. There are several so-called **NP-hard** problems, which most people believe *cannot* be solved in polynomial time, even though nobody can prove a super-polynomial lower bound.

A *decision problem* is a problem whose output is a single boolean value: YES or NO. Let me define three classes of decision problems:

- **P** is the set of decision problems that can be solved in polynomial time. Intuitively, P is the set of problems that can be solved quickly.
- **NP** is the set of decision problems with the following property: If the answer is YES, then there is a *proof* of this fact that can be checked in polynomial time. Intuitively, NP is the set of decision problems where we can verify a YES answer quickly if we have the solution in front of us.
- **co-NP** is essentially the opposite of NP. If the answer to a problem in co-NP is NO, then there is a proof of this fact that can be checked in polynomial time.

For example, the circuit satisfiability problem is in NP. If a given boolean circuit is satisfiable, then any set of m input values that produces TRUE output is a proof that the circuit is satisfiable; we can check the proof by evaluating the circuit in polynomial time. It is widely believed that circuit satisfiability is *not* in P or in co-NP, but nobody actually knows.

Every decision problem in P is also in NP. If a problem is in P, we can verify YES answers in polynomial time recomputing the answer from scratch! Similarly, every problem in P is also in co-NP.

Perhaps the single most important unanswered question in theoretical computer science—if not all of computer science—if not all of **science**—is whether the complexity classes P and NP are actually different. Intuitively, it seems obvious to most people that $P \neq NP$; the homeworks and exams in this class and others have (I hope) convinced you that problems can be incredibly hard to solve, even when the solutions are obvious in retrospect. It’s completely obvious; *of course* solving problems from scratch is harder than just checking that a solution is correct. We can quite reasonably accept the statement “ $P \neq NP$ ” as a law of nature.

¹This notion of efficiency was independently formalized by Alan Cobham (The intrinsic computational difficulty of functions. *Logic, Methodology, and Philosophy of Science (Proc. Int. Congress)*, 24–30, 1965), Jack Edmonds (Paths, trees, and flowers. *Canadian Journal of Mathematics* 17:449–467, 1965), and Michael Rabin (Mathematical theory of automata. *Proceedings of the 19th ACM Symposium in Applied Mathematics*, 153–175, 1966), although similar notions were considered more than a decade earlier by Kurt Gödel and John von Neumann.

But nobody knows how to *prove* $P \neq NP$. In fact, there has been little or no real progress toward a proof for decades.² The Clay Mathematics Institute lists P versus NP as the first of its seven Millennium Prize Problems, offering a \$1,000,000 reward for its solution. And yes, in fact, several people *have* lost their souls attempting to solve this problem.

A more subtle but still open question is whether the complexity classes NP and co-NP are different. Even if we can verify every YES answer quickly, there's no reason to believe we can also verify No answers quickly. For example, as far as we know, there is no short proof that a boolean circuit is *not* satisfiable. It is generally believed that $NP \neq \text{co-NP}$, but again, nobody knows how to prove it.

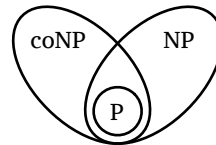

Figure 10.3. What we *think* the world looks like.

10.3 NP-hard, NP-easy, and NP-complete

A problem Π is **NP-hard** if a polynomial-time algorithm for Π would imply a polynomial-time algorithm for *every problem in NP*. In other words:

Π is NP-hard \iff If Π can be solved in polynomial time, then $P=NP$

Intuitively, if we could solve one particular NP-hard problem quickly, then we could quickly solve *any* problem whose solution is easy to understand, using the solution to that one special problem as a subroutine. NP-hard problems are at least as hard as every problem in NP.

Finally, a problem is **NP-complete** if it is both NP-hard and an element of NP (or “NP-easy”). Informally, NP-complete problems are the hardest problems in NP. A polynomial-time algorithm for even one NP-complete problem would immediately imply a polynomial-time algorithm for *every* NP-complete problem. Literally *thousands* of problems have been shown to be NP-complete, so a polynomial-time algorithm for one (and therefore all) of them seems incredibly unlikely.

Calling a problem NP-hard is like saying “If I own a dog, then it can speak fluent English.” You probably don’t know whether or not I own a dog, but I bet you’re pretty sure that I don’t own a *talking* dog. Nobody has a mathematical *proof* that dogs can’t

²Perhaps the most significant progress has taken the form of *barrier* results, which imply that entire avenues of attack are doomed to fail. In a very real sense, these results actually *prove* that we have no idea how to prove $P \neq NP$!

speak English—the fact that no one has ever heard a dog speak English is evidence, as are the hundreds of examinations of dogs that lacked the proper mouth shape and brainpower, but mere evidence is not a mathematical proof. Nevertheless, no sane person would believe me if I said I owned a dog that spoke fluent English. So the statement “If I own a dog, then it can speak fluent English” has a natural corollary: No one in their right mind should believe that I own a dog! Likewise, if a problem is NP-hard, no one in their right mind should believe it can be solved in polynomial time.

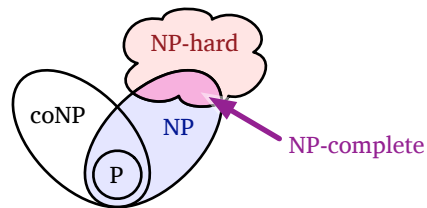

Figure 10.4. More of what we *think* the world looks like.

It is not immediately clear that *any* problems are NP-hard. The following remarkable theorem was first published by Steve Cook in 1971 and independently by Leonid Levin in 1973.³ I won’t even sketch the proof here, since I’ve been (deliberately) vague about the definitions; interested readers find a proof in my lecture notes on nondeterministic Turing machines.

The Cook-Levin Theorem. *Circuit satisfiability is NP-hard.*

*10.4 Formal Definitions (HC SVNT DRACONES)

Formally, the complexity classes P, NP, and co-NP are defined in terms of *languages* and *Turing machines*. A language is just a set of strings over some finite alphabet Σ ; without loss of generality, we can assume that $\Sigma = \{0, 1\}$. P is the set of languages that can be decided in *Polynomial* time by a deterministic single-tape Turing machine. Similarly, NP is the set of all languages that can be decided in polynomial time by a nondeterministic Turing machine; NP is an abbreviation for *Nondeterministic Polynomial-time*.

The requirement of polynomial time is sufficiently crude that we do not have to specify the precise form of Turing machine (number of tapes, number of heads, number of tracks, size of the tape alphabet, and so on). In fact, any algorithm that runs on a

³Levin first reported his results at seminars in Moscow in 1971, while still a PhD student. News of Cook’s result did not reach the Soviet Union until at least 1973, after Levin’s announcement of his results had been published; in accordance with Stigler’s Law, this result is often called “Cook’s Theorem”. Levin was denied his PhD at Moscow University for political reasons; he emigrated to the US in 1978 and earned a PhD at MIT a year later. Cook was denied tenure at Berkeley in 1970, just one year before publishing his seminal paper; he (but not Levin) later won the Turing award for his proof.

random-access machine⁴ in $T(n)$ time can be simulated by a single-tape, single-track, single-head Turing machine that runs in $O(T(n)^4)$ time. This simulation result allows us to argue formally about computational complexity in terms of standard high-level programming constructs like for-loops and recursion, instead of describing everything directly in terms of Turing machines.

Formally, a problem Π is NP-hard if and only if, for every language $\Pi' \in \text{NP}$, there is a polynomial-time **Turing reduction** from Π' to Π . A Turing reduction just means a reduction that can be executed on a Turing machine; that is, a Turing machine M that can solve Π' using another Turing machine M' for Π as a black-box subroutine. Turing reductions are also called *oracle reductions*; polynomial-time Turing reductions are also called *Cook reductions*.

Researchers in complexity theory prefer to define NP-hardness in terms of polynomial-time **many-one reductions**, which are also called *Karp reductions*. A *many-one* reduction from one language $L' \subseteq \Sigma^*$ to another language $L \subseteq \Sigma^*$ is an function $f: \Sigma^* \rightarrow \Sigma^*$ such that $x \in L'$ if and only if $f(x) \in L$. Then we can define a *language* L to be NP-hard if and only if, for any language $L' \in \text{NP}$, there is a many-one reduction from L' to L that can be computed in polynomial time.

Every Karp reduction “is” a Cook reduction, but not vice versa. Specifically, any Karp reduction from one decision problem Π to another decision Π' is equivalent to transforming the input to Π into the input for Π' , invoking an oracle (that is, a subroutine) for Π' , and then returning the answer verbatim. However, as far as we know, not every Cook reduction can be simulated by a Karp reduction.

Complexity theorists prefer Karp reductions primarily because NP is closed under Karp reductions, but is *not* closed under Cook reductions (unless $\text{NP}=\text{co-NP}$, which is considered unlikely). There are natural problems that are (1) NP-hard with respect to Cook reductions, but (2) NP-hard with respect to Karp reductions only if $\text{P}=\text{NP}$. One trivial example is of such a problem is UNSAT : Given a boolean formula, is it *always false*? On the other hand, many-one reductions apply *only* to decision problems (or more formally, to languages); formally, no optimization or construction problem is Karp-NP-hard.

To make things even more confusing, both Cook and Karp originally defined NP-hardness in terms of **logarithmic-space** reductions. Every logarithmic-space reduction is a polynomial-time reduction, but (as far as we know) not vice versa. It is an open question whether relaxing the set of allowed (Cook or Karp) reductions from logarithmic-space to polynomial-time changes the set of NP-hard problems.

⁴Random-access machines are a model of computation that more faithfully models physical computers. A random-access machine has unbounded random-access memory, modeled as an array $M[0.. \infty]$ where each address $M[i]$ holds a single w -bit integer, for some fixed integer w , and can read to or write from any memory addresses in constant time. RAM algorithms are formally written in assembly-like language, using instructions like **ADD** i, j, k (meaning “ $M[i] \leftarrow M[j] + M[k]$ ”), **INDIR** i, j (meaning “ $M[i] \leftarrow M[M[j]]$ ”), and **IFZGOTO** i, ℓ (meaning “if $M[i] = 0$, go to line ℓ ”). In practice, RAM algorithms can be faithfully described using higher-level pseudocode, as long as we’re careful about arithmetic precision.

Fortunately, none of these subtleties raise their ugly heads in practice—in particular, every algorithmic reduction described in these notes can be formalized as a logarithmic-space many-one reduction—so you can wake up now.

10.5 Reductions and SAT

To prove that any problem other than Circuit satisfiability is NP-hard, we use a *reduction argument*. Reducing problem A to another problem B means describing an algorithm to solve problem A under the assumption that an algorithm for problem B already exists. You're already used to doing reductions, only you probably call it something else, like writing subroutines or utility functions, or modular programming. To prove something is NP-hard, we describe a similar transformation between problems, but not in the direction that most people expect.

You should tattoo the following rule of onto the back of your hand, right next to your mom's birthday and the *actual* rules of Monopoly.⁵

To prove that problem A is NP-hard, reduce a known NP-hard problem to A.

In other words, to prove that your problem is hard, you need to describe an algorithm to solve a *different* problem, which you already know is hard, using a magical mystery algorithm for *your* problem as a subroutine. The essential logic is a proof by contradiction. The reduction implies that if your problem were easy, then the other problem would be easy, which it ain't. Equivalently, since you know the other problem is hard, the reduction implies that your problem must also be hard.

As a canonical example, consider the *formula satisfiability* problem, usually just called **SAT**. The input to SAT is a boolean *formula* like

$$(a \vee b \vee c \vee \bar{d}) \Leftrightarrow ((b \wedge \bar{c}) \vee \overline{(a \Rightarrow d)} \vee (c \neq a \wedge b)),$$

and the question is whether it is possible to assign boolean values to the variables a, b, c, \dots so that the entire formula evaluates to TRUE.

To prove that SAT is NP-hard, we need to give a reduction from a known NP-hard problem. The only problem we know is NP-hard so far is CIRCUITSAT, so let's start there.

Let K be an arbitrary boolean circuit. We can transform K into a boolean formula Φ by creating new output variables for each gate, and then just writing down the list of

⁵If a player lands on an available property and declines (or is unable) to buy it, that property is immediately auctioned off to the highest bidder; the player who originally declined the property may bid, and bids may be arbitrarily higher or lower than the list price. Players in Jail can still buy and sell property, buy and sell houses and hotels, and collect rent. The game has 32 houses and 12 hotels; once they're gone, they're gone. In particular, if all houses are already on the board, you cannot downgrade a hotel to four houses; you must sell all three hotels in the group. Players can sell/exchange undeveloped properties, but not buildings or cash. A player landing on Free Parking does not win anything. A player landing on Go gets \$200, no more. Railroads are not magic transporters. Finally, Jeff *always* gets the car.

gates separated by ANDs. For example, our example circuit would be transformed into a formula as follows:

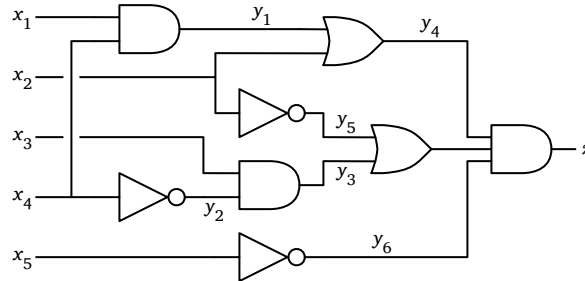

$$(y_1 = x_1 \wedge x_4) \wedge (y_2 = \overline{x_4}) \wedge (y_3 = x_3 \wedge y_2) \wedge (y_4 = y_1 \vee x_2) \wedge (y_5 = \overline{x_2}) \wedge (y_6 = \overline{x_5}) \wedge (y_7 = y_3 \vee y_5) \wedge (z = y_4 \wedge y_7 \wedge y_6) \wedge z$$

Now we claim that the original circuit K is satisfiable **if and only if** the resulting formula Φ is satisfiable. Like every other “if and only if” statement, we prove this claim in two steps:

- ⇒ Given a set of inputs that satisfy the circuit K , we can obtain a satisfying assignment for the formula Φ by computing the output of every gate in K .
 - ⇐ Given a satisfying assignment for the formula Φ , we can obtain a satisfying input to the circuit by simply ignoring the internal gate variables y_i and the output variable z .
- The entire transformation from circuit to formula can be carried out in linear time. Moreover, the size of the resulting formula is at most a constant factor larger than any reasonable representation of the circuit.

Now suppose, for the sake of argument, there is a magical mystery algorithm that can determine in polynomial time whether a given boolean formula is satisfiable. Then given any boolean circuit K , we can decide whether K is satisfiable by first transforming K into a boolean formula Φ as described above, and then asking our magical mystery SAT algorithm whether Φ is satisfiable, as suggested by the following cartoon. Each box represents an algorithm. The red box on the left is the transformation subroutine. The box on the right the magical SAT algorithm; it *must* be magic, because it has a rainbow on it!⁶

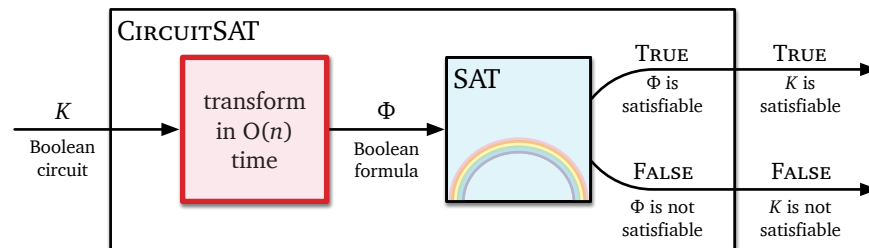

⁶Katherine Z. Erickson. Personal communication, 2011.

If you prefer pseudocode to rainbows:

CIRCUITSAT(K):
 transcribe K into a boolean formula Φ
 return SAT(Φ) *⟨⟨Magic!⟩⟩*

Transcribing K into Φ requires only polynomial time (in fact, only *linear* time, but whatever), so the entire CIRCUITSAT algorithm also runs in polynomial time.

$$T_{\text{CIRCUITSAT}}(n) \leq O(n) + T_{\text{SAT}}(O(n))$$

We conclude that any polynomial-time algorithm for SAT would give us a polynomial-time algorithm for CIRCUITSAT, which in turn would imply $P=NP$. So SAT is NP-hard!

10.6 3SAT (from SAT)

A special case of SAT that is particularly useful in proving NP-hardness results is called **3CNF-SAT** or more often just **3SAT**.

A boolean formula is in *conjunctive normal form* (CNF) if it is a conjunction (AND) of several *clauses*, each of which is the disjunction (OR) of several *literals*, each of which is either a variable or its negation. For example:

$$\overbrace{(a \vee b \vee c \vee d)}^{\text{clause}} \wedge (b \vee \bar{c} \vee \bar{d}) \wedge (\bar{a} \vee c \vee d) \wedge (a \vee \bar{b})$$

A *3CNF* formula is a CNF formula with exactly three literals per clause; the previous example is not a 3CNF formula, since its first clause has four literals and its last clause has only two. 3SAT is just SAT restricted to 3CNF formulas: Given a 3CNF formula, is there an assignment to the variables that makes the formula evaluate to TRUE?

We could prove that 3SAT is NP-hard by a reduction from the more general SAT problem, but it's easier just to start over from scratch, by reducing directly from CIRCUITSAT.

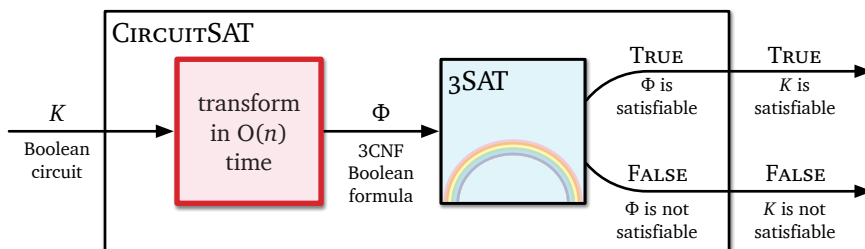

Figure 10.5. A polynomial-time reduction from CIRCUITSAT to 3SAT.

Given an arbitrary boolean circuit K , we transform K into an equivalent 3CNF formula in several stages.

- *Make sure every AND and OR gate in K has exactly two inputs.* If any gate has $k > 2$ inputs, replace it with a binary tree of $k - 1$ two-input gates. Call the resulting circuit K' .
- *Transcribe K' into a boolean formula Φ_1 with one clause per gate, exactly as in our previous reduction to SAT.*
- *Replace each clause in Φ_1 with a CNF formula.* There are only three types of clauses in Φ_1 , one for each type of gate in K' :

$$\begin{aligned} a = b \wedge c &\longmapsto (a \vee \bar{b} \vee \bar{c}) \wedge (\bar{a} \vee b) \wedge (\bar{a} \vee c) \\ a = b \vee c &\longmapsto (\bar{a} \vee b \vee c) \wedge (a \vee \bar{b}) \wedge (a \vee \bar{c}) \\ a = \bar{b} &\longmapsto (a \vee b) \wedge (\bar{a} \vee \bar{b}) \end{aligned}$$

Call the resulting CNF formula Φ_2 .

- *Replace each clause in Φ_2 with a 3CNF formula.* Every clause in Φ_2 has at most three literals. We can keep the three-literal clauses as-is. We expand each two-literal clause into two three-literal clauses by introducing a new variable. Finally, we expand any one-literal clause into four three-literal clauses by introducing two new variables.

$$\begin{aligned} a \vee b &\longmapsto (a \vee b \vee x) \wedge (a \vee b \vee \bar{x}) \\ a &\longmapsto (a \vee x \vee y) \wedge (a \vee \bar{x} \vee y) \wedge (a \vee x \vee \bar{y}) \wedge (a \vee \bar{x} \vee \bar{y}) \end{aligned}$$

Call the final 3CNF formula Φ_3 .

For example, our example circuit is transformed into the following 3CNF formula:

$$\begin{aligned} &(y_1 \vee \bar{x}_1 \vee \bar{x}_4) \wedge (\bar{y}_1 \vee x_1 \vee z_1) \wedge (\bar{y}_1 \vee x_1 \vee \bar{z}_1) \wedge (\bar{y}_1 \vee x_4 \vee z_2) \wedge (\bar{y}_1 \vee x_4 \vee \bar{z}_2) \\ &\quad \wedge (y_2 \vee x_4 \vee z_3) \wedge (y_2 \vee x_4 \vee \bar{z}_3) \wedge (\bar{y}_2 \vee \bar{x}_4 \vee z_4) \wedge (\bar{y}_2 \vee \bar{x}_4 \vee \bar{z}_4) \\ &\wedge (y_3 \vee \bar{x}_3 \vee \bar{y}_2) \wedge (\bar{y}_3 \vee x_3 \vee z_5) \wedge (\bar{y}_3 \vee x_3 \vee \bar{z}_5) \wedge (\bar{y}_3 \vee y_2 \vee z_6) \wedge (\bar{y}_3 \vee y_2 \vee \bar{z}_6) \\ &\wedge (\bar{y}_4 \vee y_1 \vee x_2) \wedge (y_4 \vee \bar{x}_2 \vee z_7) \wedge (y_4 \vee \bar{x}_2 \vee \bar{z}_7) \wedge (y_4 \vee \bar{y}_1 \vee z_8) \wedge (y_4 \vee \bar{y}_1 \vee \bar{z}_8) \\ &\quad \wedge (y_5 \vee x_2 \vee z_9) \wedge (y_5 \vee x_2 \vee \bar{z}_9) \wedge (\bar{y}_5 \vee \bar{x}_2 \vee z_{10}) \wedge (\bar{y}_5 \vee \bar{x}_2 \vee \bar{z}_{10}) \\ &\quad \wedge (y_6 \vee x_5 \vee z_{11}) \wedge (y_6 \vee x_5 \vee \bar{z}_{11}) \wedge (\bar{y}_6 \vee \bar{x}_5 \vee z_{12}) \wedge (\bar{y}_6 \vee \bar{x}_5 \vee \bar{z}_{12}) \\ &\wedge (\bar{y}_7 \vee y_3 \vee y_5) \wedge (y_7 \vee \bar{y}_3 \vee z_{13}) \wedge (y_7 \vee \bar{y}_3 \vee \bar{z}_{13}) \wedge (y_7 \vee \bar{y}_5 \vee z_{14}) \wedge (y_7 \vee \bar{y}_5 \vee \bar{z}_{14}) \\ &\wedge (y_8 \vee \bar{y}_4 \vee \bar{y}_7) \wedge (\bar{y}_8 \vee y_4 \vee z_{15}) \wedge (\bar{y}_8 \vee y_4 \vee \bar{z}_{15}) \wedge (\bar{y}_8 \vee y_7 \vee z_{16}) \wedge (\bar{y}_8 \vee y_7 \vee \bar{z}_{16}) \\ &\wedge (y_9 \vee \bar{y}_8 \vee \bar{y}_6) \wedge (\bar{y}_9 \vee y_8 \vee z_{17}) \wedge (\bar{y}_9 \vee y_8 \vee \bar{z}_{17}) \wedge (\bar{y}_9 \vee y_6 \vee z_{18}) \wedge (\bar{y}_9 \vee y_6 \vee \bar{z}_{18}) \\ &\quad \wedge (y_9 \vee z_{19} \vee z_{20}) \wedge (y_9 \vee \bar{z}_{19} \vee z_{20}) \wedge (y_9 \vee z_{19} \vee \bar{z}_{20}) \wedge (y_9 \vee \bar{z}_{19} \vee \bar{z}_{20}) \end{aligned}$$

At first glance, this formula may look a lot more complicated than the original circuit, but in fact, it's only larger by a constant factor—each binary gate in the original circuit has been transformed into at most five clauses. Even if the formula size were a large *polynomial* function (like n^{374}) of the circuit size, we would still have a valid reduction.

This reduction transforms the circuit into an equivalent 3CNF formula; the output formula is satisfiable if and only if the input circuit is satisfiable. As with the more

general SAT problem, the output formula Φ_3 is only a constant factor larger than any reasonable description of the original circuit K , and the reduction can be carried out in polynomial time. Thus, if 3SAT can be solved in polynomial time, then CIRCUITSAT can be solved in polynomial time, which implies that $P = NP$. We conclude 3SAT is NP-hard.

10.7 Maximum Independent Set (from 3SAT)

For the next few problems we consider, the input is a simple, unweighted graph, and the problem asks for the size of the largest or smallest subgraph satisfying some structural property.

Let G be an arbitrary graph. An *independent set* in G is a subset of the vertices of G with no edges between them. The *maximum independent set* problem, or simply *MAXINDSET*, asks for the size of the largest independent set in a given graph. I will prove that MAXINDSET is NP-hard using a reduction from 3SAT, as suggested by the following figure.

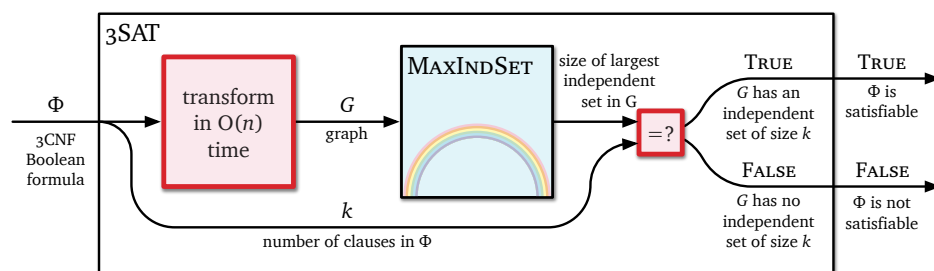

Figure 10.6. A polynomial-time reduction from 3SAT to MAXINDSET.

Given an arbitrary 3CNF formula Φ , we construct a graph G as follows. Let k denote the number of clauses in Φ . The graph G contains exactly $3k$ vertices, one for each literal in Φ . Two vertices in G are connected by an edge if and only if either (1) they correspond to literals in the same clause, or (2) they correspond to a variable and its inverse. For example, the formula $(a \vee b \vee c) \wedge (b \vee \bar{c} \vee \bar{d}) \wedge (\bar{a} \vee c \vee d) \wedge (a \vee \bar{b} \vee \bar{d})$ is transformed into the graph shown in Figure 10.7.

Any independent set in G contains at most one vertex from each clause triangle, because any two vertices in each triangle are connected. Thus, the largest independent set in G has size *at most* k . I claim that G contains an independent set of size *exactly* k if and only if the original formula Φ is satisfiable. As usual for “if and only if” statements, the proof consists of two parts.

\Rightarrow Suppose Φ is satisfiable. Fix an arbitrary satisfying assignment. By definition, each clause in Φ contains at least one TRUE literal. Thus, we can choose a subset S over k vertices in G that contains exactly one vertex per clause triangle, such that the corresponding literals are all TRUE. Because each triangle contains at most one

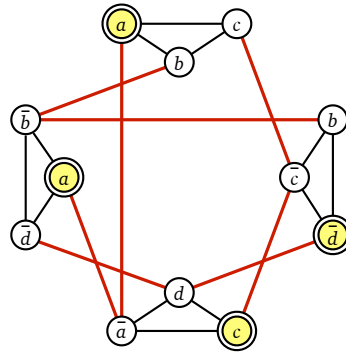

Figure 10.7. A graph derived from a satisfiable 3CNF formula, and an independent set of size 4.

vertex in S , no two vertices in S are connected by a triangle edge. Because every literal in S is TRUE, no two vertices in S are connected by a negation edge. We conclude that S is an independent set of size k in G .

- ⇐ On the other hand, suppose G contains an independent set S of size k . Each vertex in S must lie in a different clause triangle. Suppose we assign the value TRUE to each literal in S ; since contradictory literals are connected by edges, this assignment is consistent. There may be variables x such that neither x nor \bar{x} corresponds to a vertex in S ; we can set these variables to any value we like. Because S contains one vertex in each clause triangle, each clause in Φ contains (at least) one TRUE literal. We conclude that Φ is satisfiable.

Transforming the 3CNF formula Φ into the graph G takes polynomial time, even if we do everything by brute force. Thus, if we could solve MAXINDSET in polynomial time, then we could also solve 3SAT in polynomial time, by transforming the input formula Φ into a graph G and comparing the size of the largest independent set in G with the number of clauses in Φ . But that would imply $P=NP$, which is ridiculous! We conclude that MAXINDSET is NP-hard.

10.8 Clique and Vertex Cover (from Independent Set)

A **clique** is another name for a complete graph, that is, a graph where every pair of vertices is connected by an edge. The MAXCLIQUE problem asks for the number of nodes in its largest complete subgraph in a given graph. A **vertex cover** of a graph is a set of vertices that touches every edge in the graph. The MINVERTEXCOVER problem is to find the size of the smallest vertex cover in a given graph.

We can prove that MAXCLIQUE is NP-hard using the following easy reduction from MAXINDSET. Any graph G has an *edge-complement* \bar{G} with the same vertices, but with exactly the opposite set of edges— (u, v) is an edge in \bar{G} if and only if it is *not* an edge in G . A set of vertices is independent in G if and only if the same vertices define a clique

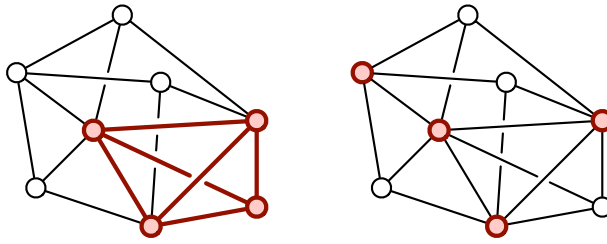

Figure 10.8. A graph whose largest clique has size 4 and whose smallest vertex cover also has size 4.

in \bar{G} . Thus, the largest independent in G has the same vertices as the largest clique in the complement of G .

The proof that **MINVERTEXCOVER** is NP-hard is even simpler, because it relies on the following easy observation: I is an independent set in a graph $G = (V, E)$ if and only if its complement $V \setminus I$ is a vertex cover of the same graph G . Thus, the *largest* independent set in any graph is just the complement of the *smallest* vertex cover of the same graph! Thus, if the smallest vertex cover in an n -vertex graph has size k , then the largest independent set has size $n - k$.

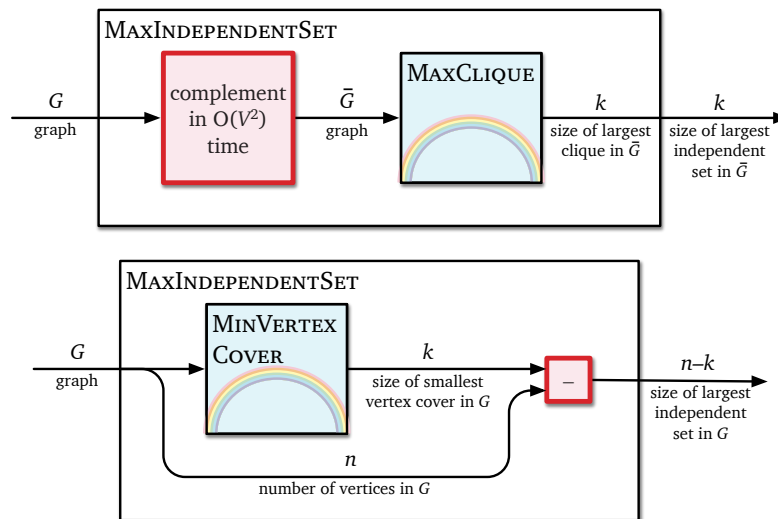

Figure 10.9. Easy reductions from **MAXINDEPENDENTSET** to **MAXCLIQUE** and **MINVERTEXCOVER**.

10.9 Graph Coloring (from 3SAT)

A *proper k -coloring* of a graph $G = (V, E)$ is a function $C : V \rightarrow \{1, 2, \dots, k\}$ that assigns one of k “colors” to each vertex, so that every edge has two different colors at its endpoints. The graph coloring problem is to find the smallest possible number of colors

in a legal coloring. To show that this problem is NP-hard, it's enough to consider the decision problem **3COLOR**: Given a graph, does it have a 3-coloring?

To prove that 3COLOR is NP-hard, we use a reduction from 3SAT. (Why 3SAT? Because it has a 3 in it. You probably think I'm joking, but I'm not.) Given a 3CNF formula Φ , we construct a graph G_Φ that is 3-colorable if and only if Φ is satisfiable.

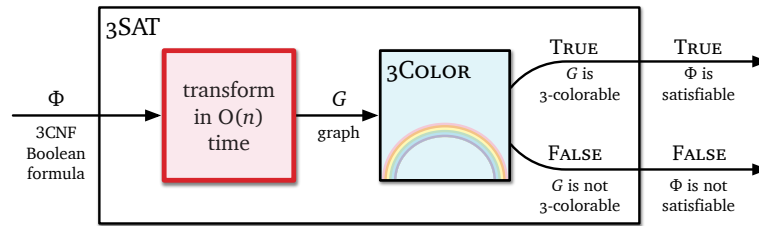

To describe the reduction, we follow a standard strategy of decomposing the output graph G_Φ into **gadgets**, which are subgraphs that correspond to various components of the input formula Φ . Decomposing reductions into separate gadgets is not only helpful for understanding existing reductions and proving them correct, but for designing new NP-hardness reductions. Our formula-to-graph reduction uses three types of gadgets:

- There is a single *truth gadget*: a triangle with three vertices T , F , and X , which intuitively stand for TRUE, FALSE, and OTHER. Since these vertices are all connected, they must have different colors in any 3-coloring. For the sake of convenience, we will *name* those colors TRUE, FALSE, and OTHER. Thus, when we say that a node is colored TRUE, all we mean is that it must be colored the same as the node T .
- For each variable a , the graph contains a *variable gadget*, which is also a triangle joining two new nodes labeled a and \bar{a} to node X in the truth gadget. Node a must be colored either TRUE or FALSE, and so node \bar{a} must be colored either FALSE or TRUE, respectively.

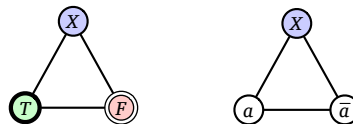

Figure 10.10. The truth gadget and a variable gadget for a .

- Finally, for each clause in Φ , the graph contains a *clause gadget*. Each clause gadget joins three literal nodes (from the corresponding variable gadgets) to node T (from the truth gadget) using five new unlabeled nodes and ten edges; see the figure below. A straightforward case analysis implies that if all three literal nodes in the clause gadget are colored FALSE, then some edge in the gadget must be monochromatic. Since the variable gadgets force each literal node to be colored either TRUE or FALSE, in any valid 3-coloring, at least one of the three literal nodes is colored TRUE. On the

other hand, for any coloring of the literal nodes where at least one literal node is colored TRUE, there is a valid 3-coloring of the clause gadget.

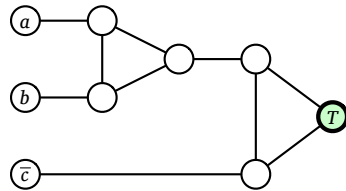

Figure 10.11. A clause gadget for $(a \vee b \vee \bar{c})$.

The final graph G_Φ contains exactly *one* node T , exactly *one* node F , and exactly *two* nodes a and \bar{a} for each variable. For example, the formula $(a \vee b \vee c) \wedge (b \vee \bar{c} \vee \bar{d}) \wedge (\bar{a} \vee c \vee d) \wedge (a \vee \bar{b} \vee \bar{d})$ that I used to illustrate the MAXCLIQUE reduction would be transformed into the graph shown below. The 3-coloring is one of several that correspond to the satisfying assignment $a = c = \text{TRUE}$, $b = d = \text{FALSE}$.

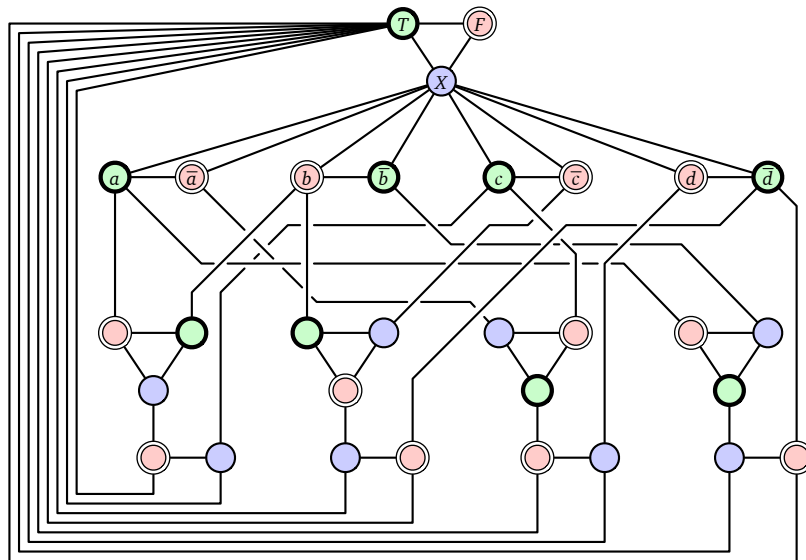

Figure 10.12. The 3-colorable graph derived from the satisfiable 3CNF formula $(a \vee b \vee c) \wedge (b \vee \bar{c} \vee \bar{d}) \wedge (\bar{a} \vee c \vee d) \wedge (a \vee \bar{b} \vee \bar{d})$

Now the proof of correctness is just brute force case analysis. If the graph is 3-colorable, then we can extract a satisfying assignment from any 3-coloring—at least one of the three literal nodes in every clause gadget is colored TRUE. Conversely, if the formula is satisfiable, then we can color the graph according to any satisfying assignment.

Because 3COLOR is a special case of the more general graph coloring problem—What is the minimum number of colors?—the more general optimization problem is also NP-hard.

10.10 Hamiltonian Cycle

A *Hamiltonian cycle* in a graph is a cycle that visits every vertex exactly once. (This is very different from an *Eulerian cycle*, which is actually a closed *walk* that traverses every *edge* exactly once; Eulerian cycles are easy to find and construct in linear time using a variant of depth-first search.) Here I describe two different proofs that the Hamiltonian cycle problem for directed graphs is NP-hard.

From Vertex Cover

Our first NP-hardness proof uses a reduction from the decision version of the vertex cover problem. Given an undirected graph G and an integer k , we need to transform it into another graph H , such that H has a Hamiltonian cycle if and only if G has a vertex cover of size k .

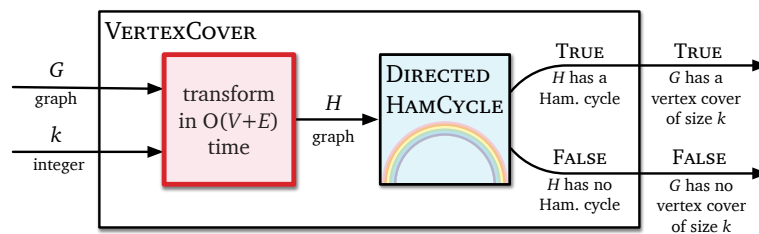

As in our previous reductions, the output graph H is composed of several gadgets, each corresponding to certain features of the inputs G and k .

- For each undirected edge uv in G , the directed graph H contains an *edge gadget* consisting of four vertices (u, v, in) , (u, v, out) , (v, u, in) , (v, u, out) and six directed edges

$$\begin{array}{lll} (u, v, \text{in}) \rightarrow (u, v, \text{out}) & (u, v, \text{in}) \rightarrow (v, u, \text{in}) & (v, u, \text{in}) \rightarrow (u, v, \text{in}) \\ (v, u, \text{in}) \rightarrow (v, u, \text{out}) & (u, v, \text{out}) \rightarrow (v, u, \text{out}) & (v, u, \text{out}) \rightarrow (u, v, \text{out}) \end{array}$$

as shown on the next page. Each “in” vertex has an additional incoming edge, and each “out” vertex has an additional outgoing edge. A Hamiltonian cycle must pass through an edge gadget in one of three ways—either straight through on both sides, or with a detour from one side to the other and back. Eventually, these options will correspond to both u and v , only u , or only v belonging to some vertex cover.

- For each vertex u in G , all the edge gadgets for incident edges uv are connected in H into a single directed path, which we call a *vertex chain*. Specifically, suppose vertex u has d neighbors v_1, v_2, \dots, v_d . Then H has $d - 1$ additional edges $(u, v_i, \text{out}) \rightarrow (u, v_{i+1}, \text{in})$ for each i .

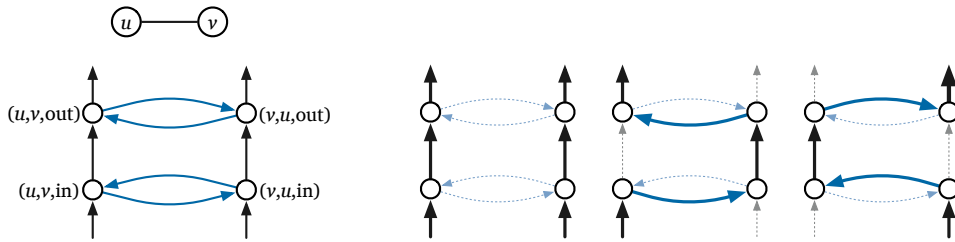

Figure 10.13. An edge gadget and its only possible intersections with a Hamiltonian cycle.

- Finally, H also contains k cover vertices x_1, x_2, \dots, x_k . Each cover vertex has a directed edge to the first vertex in each vertex chain, and a directed edge from the last vertex in each vertex chain.

An example of our complete transformation is shown below. As usual, we prove that the reduction is correct in two stages.

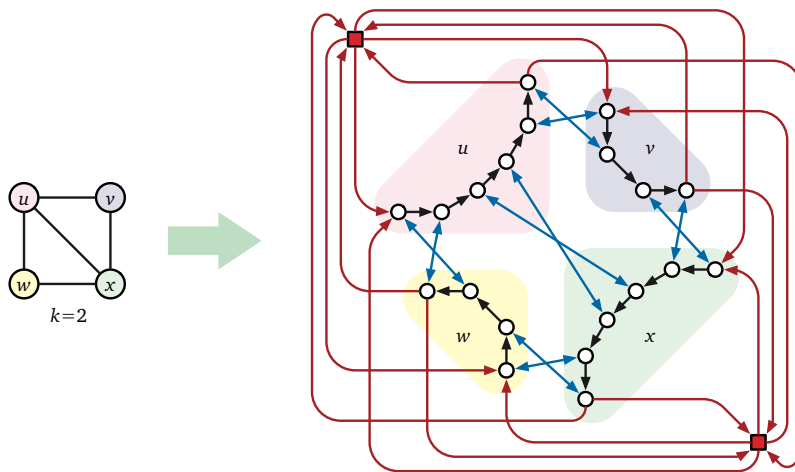

Figure 10.14. Reduction from VERTEXCOVER to HAMILTONIANCYCLE.

\Rightarrow First, suppose $C = \{u_1, u_2, \dots, u_k\}$ is a vertex cover of G . Then H contains a Hamiltonian cycle, constructed as follows. For each index i from 1 to k , we traverse a path from cover vertex x_i , through the vertex chain for u_i , to cover vertex x_{i+1} (or cover vertex x_1 if $i = k$). As we traverse the chain for each vertex u_i , we determine how to proceed from each node (u_i, v, in) as follows:

- If $v \in C$, just follow the edge $(u_i, v, in) \rightarrow (u_i, v, out)$.
- If $v \notin C$, detour through the path $(u_i, v, in) \rightarrow (v, u_i, in) \rightarrow (v, u_i, out) \rightarrow (u_i, v, out)$.

Thus, for each edge uv of G , the Hamiltonian cycle visits (u, v, in) and (u, v, out) as part of u 's vertex chain if $u \in C$ and as part of v 's vertex chain otherwise. An example of this construction appears on the next page.

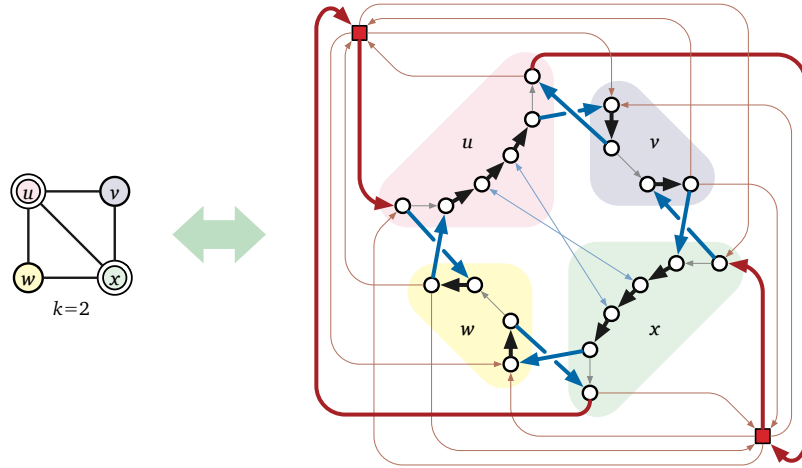

Figure 10.15. Every vertex cover of size k in G corresponds to a Hamiltonian cycle in H and vice versa.

\Leftarrow On the other hand, suppose H contains a Hamiltonian cycle C . This cycle must contain an edge from each cover vertex to the start of some vertex chain. Our case analysis of edge gadgets inductively implies that after C enters the vertex chain for some vertex u , it must traverse the entire vertex chain. Specifically, at each vertex (u, v, in) , the cycle must contain either the single edge $(u, v, \text{in}) \rightarrow (u, v, \text{out})$ or the detour path $(u, v, \text{in}) \rightarrow (v, u, \text{in}) \rightarrow (v, u, \text{out}) \rightarrow (u, v, \text{out})$, followed by an edge to the next edge gadget in u 's vertex chain, or to a cover vertex if this is the last such edge gadget. In particular, if C contains the detour edge $(u, v, \text{in}) \rightarrow (v, u, \text{in})$, it does not contain edges between any cover vertex and v 's vertex chain. It follows that C traverses exactly k vertex chains. Moreover, these vertex chains describe a vertex cover of the original graph G , because C visits the vertex (u, v, in) for every edge uv in G .

We conclude that G has a vertex cover of size k if and only if H contains a Hamiltonian cycle. The transformation from G to H takes at most $O(n^2)$ time; it follows that the directed Hamiltonian cycle problem is NP-hard.

From 3SAT

Alternatively, we can prove that the Hamiltonian cycle problem is NP-hard by reducing directly from 3SAT. Given a 3CNF formula Φ with n variables x_1, x_2, \dots, x_n and k clauses c_1, c_2, \dots, c_k , we construct a directed graph H_Φ that contains a Hamiltonian cycle if and only if Φ is satisfiable, as follows.

For each variable x_i , we construct a *variable gadget* consisting of a doubly-linked list of $2k$ vertices $(i, 0), (i, 1), \dots, (i, 2k)$, connected by edges $(i, j-1) \rightarrow (i, j)$ and $(i, j) \rightarrow (i, j-1)$ for each index j . We connect the first and last nodes in each adjacent pair of variable

gadgets by adding edges

$$(i, 0) \rightarrow (i + 1, 0) \quad (i, 2k) \rightarrow (i + 1, 0) \quad (i, 0) \rightarrow (i + 1, 2k) \quad (i, 2k) \rightarrow (i + 1, 2k)$$

for each index i ; we also connect the endpoints of the first and last variable gadgets with the edges

$$(n, 0) \rightarrow (1, 0) \quad (n, 2k) \rightarrow (1, 0) \quad (n, 0) \rightarrow (1, 2k) \quad (n, 2k) \rightarrow (1, 2k).$$

The resulting graph G_Φ has exactly 2^n Hamiltonian cycles, one for each assignment of boolean values to the n variables of Φ . Specifically, for each i , we traverse the i th variable gadget from left to right if $x_i = \text{TRUE}$ and right to left if $x_i = \text{FALSE}$.

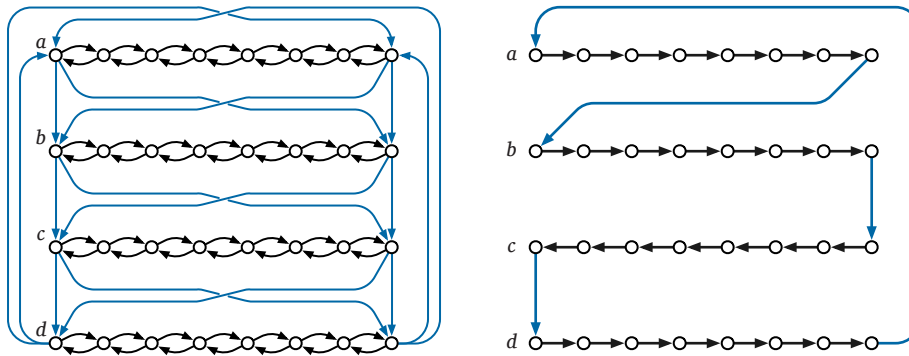

Figure 10.16. Left: Variable gadgets in G_Φ . Right: The Hamiltonian cycle in G_Φ for $a = b = d = \text{TRUE}$, $c = \text{FALSE}$

Now we extend G_Φ to a larger graph H_Φ by adding a *clause vertex* $[j]$ for each clause c_j , connected to the variable gadgets by six edges. Specifically, for each positive literal x_i in c_j , we add the edges $(i, 2j - 1) \rightarrow [j] \rightarrow (i, 2j)$, and for each negative literal \bar{x}_i in c_j , we add the edges $(i, 2j) \rightarrow [j] \rightarrow (i, 2j - 1)$. The connections to the clause vertices guarantee that a Hamiltonian cycle in G_Φ can be extended to a Hamiltonian cycle in H_Φ if and only if the corresponding variable assignment satisfies Φ . Exhaustive case analysis now implies that H_Φ has a Hamiltonian cycle if and only if Φ is satisfiable.

Transforming the formula Φ into the graph H_Φ takes $O(kn)$ time, which is at most quadratic in the total length of the formula; we conclude that the directed Hamiltonian cycle problem is NP-hard.

Variants and Extensions

Trivial modifications of the previous reductions imply that the Hamiltonian *path* problem is also NP-hard. A Hamiltonian path in a graph G is of course a simple path that visits every vertex of G exactly once. In fact, there are simple polynomial-time reductions from HAMILTONIANCYCLE to HAMILTONIANPATH and vice versa. I'll leave the details of these reductions as easy exercises.

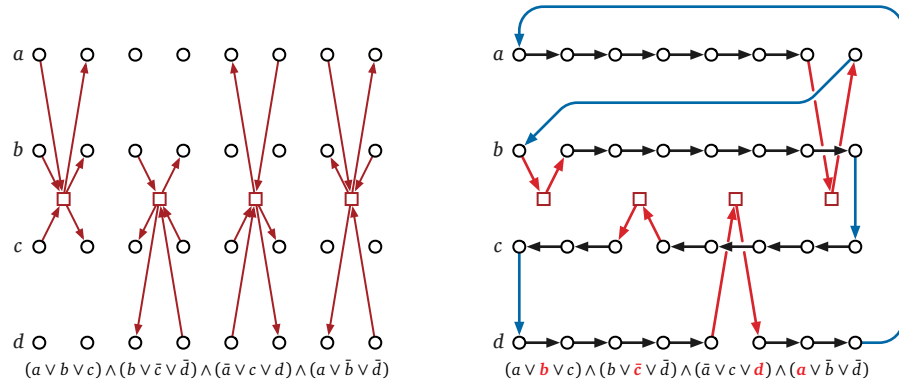

Figure 10.17. Left: Clause gadgets in H_ϕ . Right: A Hamiltonian cycle in H_ϕ corresponding to the satisfying assignment $a = b = d = \text{TRUE}$, $c = \text{FALSE}$.

Both of the previous reductions deal with directed graphs, but the corresponding question in undirected graph is also NP-hard. In fact, there is a relatively simple reduction from the directed Hamiltonian cycle problem to the undirected Hamiltonian cycle problem; again, I'll leave the details of this reduction as an entertaining exercise.

Finally, the infamous *traveling salesman problem* asks to find the shortest Hamiltonian cycle (or path) in a graph with weighted edges. Since finding the shortest cycle/path is obviously harder than determining if a cycle/path exists at all—Consider a graph where every edge has weight 1!—the traveling salesman problem is also NP-hard.

10.11 Subset Sum (from Vertex Cover)

The next problem that we prove NP-hard is the SUBSETSUM problem considered in the very first lecture on recursion: Given a set X of positive integers and an integer T , determine whether X has a subset whose elements sum to T .

To prove this problem is NP-hard, we once again reduce from VERTEXCOVER. Given a graph G and an integer k , we need to compute a set X of positive integers and an integer T , such that X has a subset that sums to T if and only if G has a vertex cover of size k . Our transformation uses just two “gadgets”, which are *integers* representing the vertices and edges in G .

Number the *edges* of G arbitrarily from 0 to $m - 1$. Our set X contains the integer $b_i := 4^i$ for each edge i , and the integer

$$a_v := 4^m + \sum_{i \in \Delta(v)} 4^i$$

for each vertex v , where $\Delta(v)$ is the set of edges that have v as an endpoint. Alternately, we can think of each integer in X as an $(m + 1)$ -digit number written in base 4. The m th digit is 1 if the integer represents a vertex, and 0 otherwise; and for each $i < m$, the i th

digit is 1 if the integer represents edge i or one of its endpoints, and 0 otherwise. Finally, we set the target sum

$$T := k \cdot 4^m + \sum_{i=0}^{m-1} 2 \cdot 4^i.$$

Now let's prove that the reduction is correct.

⇒ First, suppose there is a vertex cover of size k in the original graph G . Consider the subset $X_C \subseteq X$ that includes a_v for every vertex v in the vertex cover, and b_i for every edge i that has *exactly one* vertex in the cover. The sum of these integers, written in base 4, has a 2 in each of the first m digits; in the most significant digit, we are summing exactly k 1's. Thus, the sum of the elements of X_C is exactly T .

⇐ On the other hand, suppose there is a subset $X' \subseteq X$ that sums to t . Specifically, we must have

$$\sum_{v \in V'} a_v + \sum_{i \in E'} b_i = t$$

for some subsets $V' \subseteq V$ and $E' \subseteq E$. Again, if we sum these base-4 numbers, there are no carries in the first m digits, because for each i there are only three numbers in X whose i th digit is 1. Each edge number b_i contributes only one 1 to the i th digit of the sum, but the i th digit of t is 2. Thus, for each edge in G , at least one of its endpoints must be in V' . In other words, V' is a vertex cover. On the other hand, only vertex numbers are larger than 4^m , and $\lfloor T/4^m \rfloor = k$, so V' has at most k elements. (In fact, it's not hard to see that V' has *exactly* k elements.)

For example, given the four-vertex graph $G = (V, E)$ where $V = \{u, v, w, x\}$ and $E = \{uv, uw, vw, vx, wx\}$, our set X might contain the following base-4 integers:

$$\begin{array}{ll} a_u := 111000_4 = 1344 & b_{uv} := 010000_4 = 256 \\ a_v := 110110_4 = 1300 & b_{uw} := 001000_4 = 64 \\ a_w := 101101_4 = 1105 & b_{vw} := 000100_4 = 16 \\ a_x := 100011_4 = 1029 & b_{vx} := 000010_4 = 4 \\ & b_{wx} := 000001_4 = 1 \end{array}$$

If we are looking for a vertex cover of size 2, our target sum would be $T := 222222_4 = 2730$. Indeed, the vertex cover $\{v, w\}$ corresponds to the subset $\{a_v, a_w, b_{uv}, b_{uw}, b_{vx}, b_{wx}\}$, whose sum is $1300 + 1105 + 256 + 64 + 4 + 1 = 2730$.

The reduction can clearly be performed in polynomial time. Since VERTEXCOVER is NP-hard, it follows that SUBSETSUM is NP-hard.

Caveat Reductor!

There is one subtle point that needs to be emphasized here. Way back at the beginning of the semester, we developed a dynamic programming algorithm to solve SUBSETSUM in $O(nT)$ time. Isn't this a polynomial-time algorithm? idn't we just prove that P=NP?

Hey, where's our million dollars? Alas, life is not so simple. True, the running time is a polynomial function of n and T , but in order to qualify as a true polynomial-time algorithm, the running time must be a polynomial function **of the number of bits required to represent the input**. The *values* of the elements of X and the target sum T could be exponentially larger than the number of input bits. Indeed, the reduction we just described produces a value of T that is exponentially larger than the size of our original input graph, which would force our dynamic programming algorithm to run in exponential time.

Algorithms like this are said to run in **pseudo-polynomial time**, and any NP-hard problem with such an algorithm is called **weakly NP-hard**. Equivalently, a weakly NP-hard problem is one that can be solved in polynomial time when all input numbers are represented in *unary* (as a sum of 1s), but becomes NP-hard when all input numbers are represented in *binary*. If a problem is NP-hard even when all the input numbers are represented in unary, we say that the problem is **strongly NP-hard**.

10.12 Choosing the Right Problem

Perhaps the most difficult step in proving that a problem is NP-hard is choose the bet problem to reduce from. The Cook-Levin Theorem implies that if there is a reduction from *any* NP-hard problem to problem X , then there is a reduction from *every* NP-complete problem to problem X , but some problems work better than others. There's no systematic method for choosing the right problem, but here are a few useful rules of thumb.

- If the problem asks how to assign bits to objects, or to partition objects into two different subsets, try reducing from some version of SAT or PARTITION.
- If the problem asks how to assign labels to objects from a small fixed set, or to partition objects into a constant number of subsets, try reducing from k COLOR or even 3COLOR.
- If the problem asks to arrange a set of objects in a particular order, try reducing from HAMILTONIANCYCLE or HAMILTONIANPATH or TRAVELINGSALESMAN.
- If the problem asks to find a *small* subset satisfying some constraints, try reducing from MINVERTEXCOVER.
- If the problem asks to find a *large* subset satisfying some constraints, try reducing from MAXINDEPENDENTSET or MAXCLIQUE.
- If the problem asks to partition objects into a large number of small subsets, try reducing from 3PARTITION.
- If the number 3 appears naturally in the problem, try 3SAT or 3COLOR or 3PARTITION. (No, this is not a joke.)
- If all else fails, try 3SAT or even CIRCUITSAT!

10.13 A Frivolous Real-World Example

Draughts is a family of board games that have been played for thousands of years. Most Americans are familiar with the version called *checkers* or *English draughts*, but the most common variant worldwide, known as *international draughts* or *Polish draughts*, originated in the Netherlands in the 16th century. For a complete set of rules, the reader should consult [Wikipedia](#); here a few important differences from the Anglo-American game:

- **Flying kings:** As in checkers, a piece that ends a move in the row closest to the opponent becomes a *king* and gains the ability to move backward. Unlike in checkers, however, a king in international draughts can move any distance along a diagonal line in a single turn, as long as the intermediate squares are empty or contain exactly one opposing piece (which is captured).
- **Forced maximum capture:** In each turn, the moving player must capture as many opposing pieces as possible. This is distinct from the forced-capture rule in checkers, which requires only that each player must capture if possible, and that a capturing move ends only when the moving piece cannot capture further. In other words, checkers requires capturing a *maximal* set of opposing pieces on each turn; whereas, international draughts requires a *maximum* capture.
- **Capture subtleties:** As in checkers, captured pieces are removed from the board only at the end of the turn. Any piece can be captured at most once. Thus, when an opposing piece is jumped, that piece remains on the board *but cannot be jumped again* until the end of the turn.

For example, in the first position shown below, each circle represents a piece, and doubled circles represent kings. Black *must* make the first indicated move, capturing five white pieces, because it is not possible to capture more than five pieces, and there is no other move that captures five. Black cannot extend his capture further, either northeast or southeast, because the captured White pieces remain on the board until his turn is over. Then White *must* make the second indicated move, thereby winning the game.

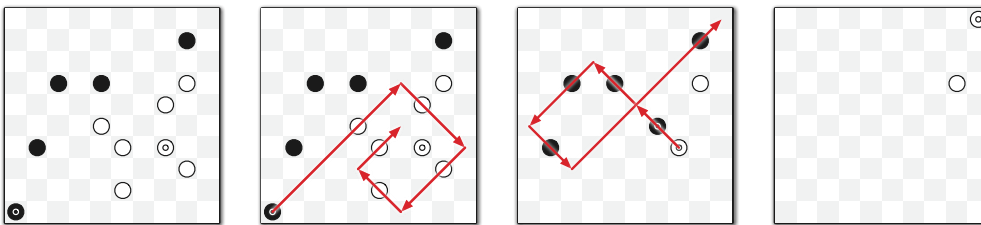

Figure 10.18. Two forced(!) moves in international draughts; doubled circles are kings.

The actual game, which is played on a 10×10 board with 20 pieces of each color, is computationally trivial; we can precompute the optimal move for both players in every

possible board configuration and hard-code the results into a lookup table of constant size. Sure, it's a *big* constant, but it's still just a constant!

But consider the natural generalization of international draughts to an $n \times n$ board. In this setting, **finding a legal move is actually NP-hard!** The following reduction from the Hamiltonian cycle problem in directed graphs was discovered by Bob Hearn in 2010.⁷ In most two-player games, finding the *best* move is NP-hard (or worse). This is the only example I know of a game where just *following the rules* is NP-hard!

Given a graph G with n vertices, we construct a board configuration for international draughts, such that White can capture a certain number of black pieces in a single move if and only if G has a Hamiltonian cycle. We treat G as a directed graph, with two arcs $u \rightarrow v$ and $v \rightarrow u$ in place of each undirected edge uv . Number the vertices arbitrarily from 1 to n . The final draughts configuration has several gadgets.

- The vertices of G are represented by rabbit-shaped *vertex gadgets*, which are evenly spaced along a horizontal line. Each arc $i \rightarrow j$ is represented by a path of two diagonal line segments from the “right ear” of vertex gadget i to the “left ear” of vertex gadget j . The path for arc $i \rightarrow j$ is located above the vertex gadgets if $i < j$, and below the vertex gadgets if $i > j$.

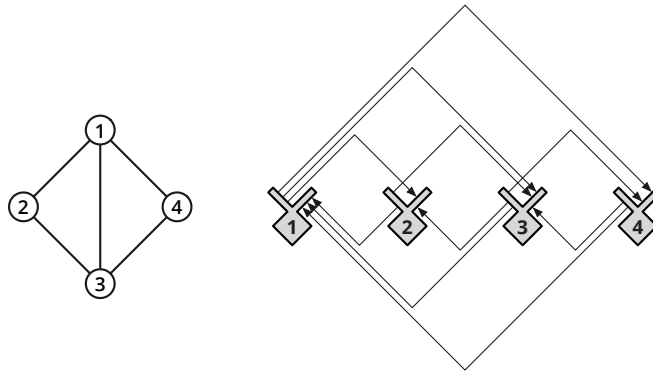

Figure 10.19. A high-level overview of the reduction from Hamiltonian cycle to international draughts.

- The bulk of each vertex gadget is a diamond-shaped region called a *vault*. The walls of the vault are composed of two solid layers of black pieces, which cannot be captured; these pieces are drawn as gray circles in the figures. There are N capturable black pieces inside each vault, for some large integer N to be determined later. A white king can enter the vault through the “right ear”, capture every internal piece, and then exit through the “left ear”. Both ears are hallways, again with walls two pieces thick, with gaps where the arc paths end to allow the white king to enter and leave. The lengths of the “ears” can be adjusted easily to align with the other gadgets.

⁷See Theoretical Computer Science Stack Exchange: <http://cstheory.stackexchange.com/a/1999/111>.

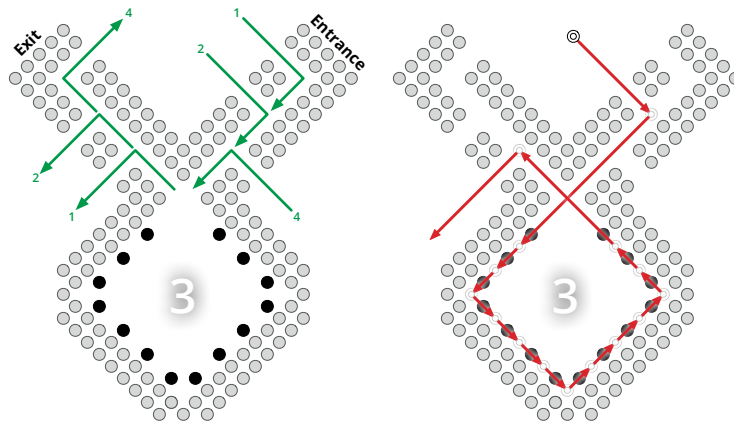

Figure 10.20. Left: A vertex gadget with three entrances and three exits. Right: A white king emptying the vault. Gray circles are black pieces that cannot be captured.

- For each arc $i \rightarrow j$, we have a *corner gadget*, which allows a white king leaving vertex gadget i to be redirected to vertex gadget j .
- Finally, wherever two arc paths cross, we have a *crossing gadget*; these gadgets allow the white king to traverse either arc path, but forbid switching from one arc path to the other.



Figure 10.21. Left: One of two paths through a corner gadget. Right: One of two paths through a crossing gadget.

A single white king starts at the bottom corner of one of the vaults. In any legal move, this king must alternate between traversing entire arc paths and clearing vaults. The king can traverse the various gadgets backward, entering each vault through the exit and vice versa. But the reversal of a Hamiltonian cycle in G is another Hamiltonian cycle in G , so walking backward is fine.

If there is a Hamiltonian cycle in G , the white king can capture at least nN black pieces by visiting each of the other vaults and returning to the starting vault. On the other hand, if there is no Hamiltonian cycle in G , the white king can capture at most half of the pieces in the starting vault, and thus can capture at most $(n - 1/2)N + O(n^3)$ enemy pieces altogether. The $O(n^3)$ term accounts for the corner and crossing gadgets; each edge passes through one corner gadget and at most $n^2/2$ crossing gadgets.

To complete the reduction, we set $N = n^4$. Summing up, we obtain an $O(n^5) \times O(n^5)$ board configuration, with $O(n^5)$ black pieces and one white king. We can clearly construct this board configuration in polynomial time. Figure 10.22 shows a complete example of the construction.

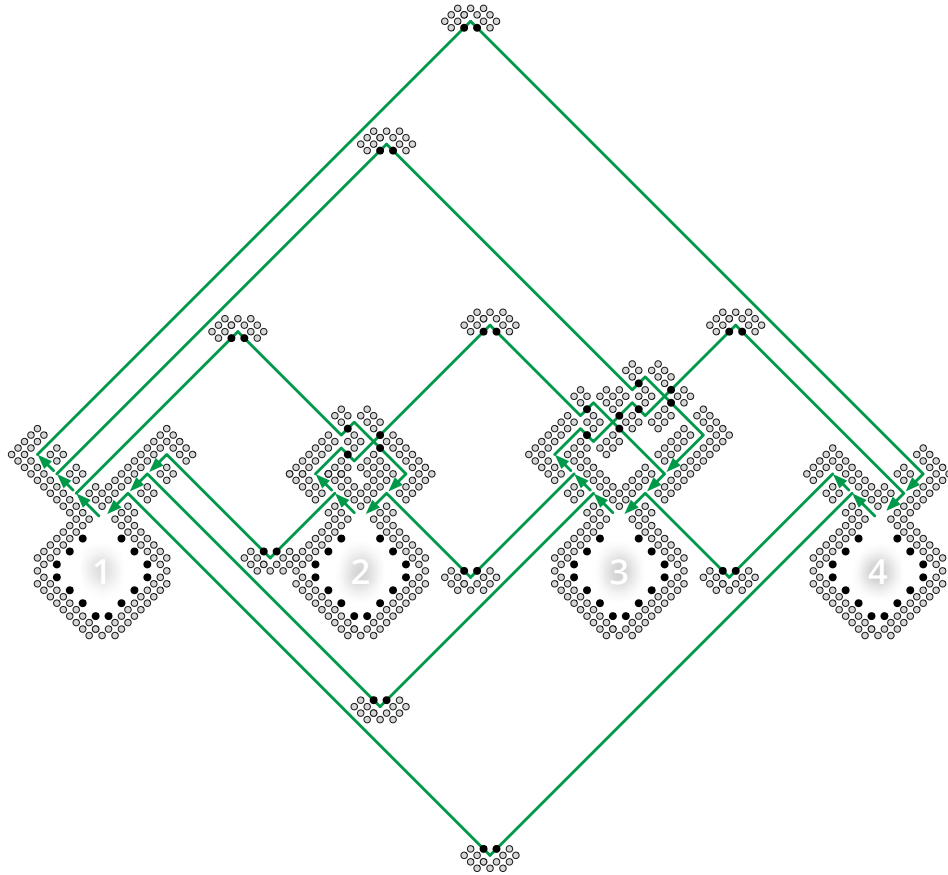

Figure 10.22. The final draughts configuration for the 4-vertex example graph. (The green arrows are not actually part of the configuration.)

It is still open whether the following related question is NP-hard: Given an $n \times n$ board configuration for international draughts, can (and therefore *must*) White capture *all* the black pieces in a single turn?

10.14 Other Useful NP-hard Problems

Literally thousands of different problems have been proved to be NP-hard. I want to close this note by listing a few NP-hard problems that are useful in deriving reductions. I won't describe the NP-hardness proofs for these problems in detail, but you can find most of them in Garey and Johnson's classic *Scary Black Book of NP-Completeness*.⁸

⁸Michael Garey and David Johnson. *Computers and Intractability: A Guide to the Theory of NP-Completeness*. W. H. Freeman and Co., 1979.

- **PLANARCIRCUITSAT:** Given a boolean circuit that can be embedded in the plane so that no two wires cross, is there an input that makes the circuit output TRUE? This problem can be proved NP-hard by reduction from the general circuit satisfiability problem, by replacing each crossing with a small series of gates.
- **1-IN-3SAT:** Given a 3CNF formula, is there an assignment of values to the variables so that every clause contains *exactly* one TRUE literal? This problem can be proved NP-hard by reduction from the usual 3SAT.
- **NOTALLEQUAL3SAT:** Given a 3CNF formula, is there an assignment of values to the variables so that every clause contains at least one TRUE literal *and* at least one FALSE literal? This problem can be proved NP-hard by reduction from the usual 3SAT.
- **PLANAR3SAT:** Given a 3CNF boolean formula, consider a bipartite graph whose vertices are the clauses and variables, where an edge indicates that a variable (or its negation) appears in a clause. If this graph is planar, the 3CNF formula is also called planar. The PLANAR3SAT problem asks, given a planar 3CNF formula, whether it has a satisfying assignment. This problem can be proved NP-hard by reduction from PLANARCIRCUITSAT.⁹
- **EXACT3DIMENSIONALMATCHING** or **X3M:** Given a set S and a collection of three-element subsets of S , called *triples*, is there a sub-collection of disjoint triples that exactly cover S ? This problem can be proved NP-hard by a reduction from 3SAT.
- **PARTITION:** Given a set S of n integers, are there subsets A and B such that $A \cup B = S$, $A \cap B = \emptyset$, and

$$\sum_{a \in A} a = \sum_{b \in B} b?$$

This problem can be proved NP-hard by a simple reduction from SUBSETSUM. Like SUBSETSUM, the PARTITION problem is only weakly NP-hard.

- **3PARTITION:** Given a set S of $3n$ integers, can it be partitioned into n disjoint three-element subsets, such that every subset has exactly the same sum? Despite the similar names, this problem is *very* different from PARTITION; sorry, I didn't make up the names. This problem can be proved NP-hard by reduction from X3M. Unlike PARTITION, the 3PARTITION problem is *strongly* NP-hard; in particular, it remains NP-hard even if every input number is at most n^3 .
- **SETCOVER:** Given a collection of sets $\mathcal{S} = \{S_1, S_2, \dots, S_m\}$, find the smallest sub-collection of S_i 's that contains all the elements of $\bigcup_i S_i$. This problem is a generalization of both VERTEXCOVER and X3M.
- **HITTINGSET:** Given a collection of sets $\mathcal{S} = \{S_1, S_2, \dots, S_m\}$, find the minimum number of elements of $\bigcup_i S_i$ that hit every set in \mathcal{S} . This problem is also a generalization of VERTEXCOVER.

⁹Surprisingly, PLANARNOTALLEQUAL3SAT is solvable in polynomial time!

- **LONGESTPATH:** Given a non-negatively weighted graph G and two vertices u and v , what is the longest simple path from u to v in the graph? A path is *simple* if it visits each vertex at most once. This problem is a generalization of the HAMILTONIANPATH problem. Of course, the corresponding *shortest* path problem can be solved in polynomial time.
- **STEINERTREE:** Given a weighted, undirected graph G with some of the vertices marked, what is the minimum-weight subtree of G that contains every marked vertex? If *every* vertex is marked, the minimum Steiner tree is just the minimum spanning tree; if exactly two vertices are marked, the minimum Steiner tree is just the shortest path between them. This problem can be proved NP-hard by reduction from VERTEXCOVER.

In addition to these dry but useful problems, most interesting puzzles and solitaire games have been shown to be NP-hard, or to have NP-hard generalizations. (Arguably, if a game or puzzle isn't at least NP-hard, it isn't interesting!) Here are some familiar examples:

- Minesweeper (by reduction from CIRCUITSAT)¹⁰
- Sudoku (by a complex reduction from 3SAT)¹¹
- Tetris (by reduction from 3PARTITION)¹²
- Klondike, aka “Solitaire” (by reduction from 3SAT)¹³
- Pac-Man (by reduction from HAMILTONIANCYCLE)¹⁴
- Super Mario Brothers (by reduction from 3SAT)¹⁵
- Candy Crush Saga (by reduction from a variant of 3SAT)¹⁶
- Threes/2048 (by reduction from 3SAT)¹⁷
- Trainyard (by reduction from DOMINATINGSET)¹⁸

¹⁰Richard Kaye. Minesweeper is NP-complete. *Mathematical Intelligencer* 22(2):9–15, 2000. <http://www.mat.bham.ac.uk/R.W.Kaye/minesw/minesw.pdf>

¹¹Takayuki Yato and Takahiro Seta. Complexity and completeness of finding another solution and its application to puzzles. *IEICE Transactions on Fundamentals of Electronics, Communications and Computer Sciences* E86-A(5):1052–1060, 2003. <http://www-imai.is.s.u-tokyo.ac.jp/~yato/data2/MasterThesis.pdf>.

¹²Ron Breukelaar*, Erik D. Demaine, Susan Hohenberger*, Hendrik J. Hoogeboom, Walter A. Kosters, and David Liben-Nowell*. Tetris is hard, even to approximate. *International Journal of Computational Geometry and Applications* 14:41–68, 2004.

¹³Luc Longpré and Pierre McKenzie. The complexity of Solitaire. *Proceedings of the 32nd International Mathematical Foundations of Computer Science*, 182–193, 2007.

¹⁴Giovanni Viglietta. Gaming is a hard job, but someone has to do it! *Theory of Computing Systems*, 54(4):595–621, 2014. <http://giovanniviglietta.com/papers/gaming2.pdf>.

¹⁵Greg Aloupis, Erik D. Demaine, Alan Guo, and Giovanni Viglietta. Classic Nintendo games Are (computationally) hard. *Theoretical Computer Science* 586:135–160, 2015. <http://arxiv.org/abs/1203.1895>.

¹⁶Luciano Gualà, Stefano Leucci, Emanuele Natale. Bejeweled, Candy Crush and other match-three games are (NP-)hard. Preprint, March 2014. <http://arxiv.org/abs/1403.5830>.

¹⁷Further evidence for the “rule of three”. Stefan Langerman and Yushi Uno. Threes!, Fives, 1024!, and 2048 are Hard. *Proc. 8th International Conference on Fun with Algorithms*, 2016.

¹⁸Matteo Almanza, Stefano Leucci, and Alessandro Panconesi. Trainyard is NP-Hard. *Proc. 8th International Conference on Fun with Algorithms*, 2016.

As of November 2016, nobody has published a proof that a generalization of Cookie Clicker is NP-hard, but I'm sure it's only a matter of time.

*10.15 On Beyond Zebra

P and NP are only the first two steps in an enormous hierarchy of complexity classes. To close this chapter, let me describe a few more classes of interest.

Polynomial Space

PSPACE is the set of decision problems that can be solved using polynomial *space*. Every problem in NP (and therefore in P) is also in PSPACE. It is generally believed that $NP \neq PSPACE$, but nobody can even prove that $P \neq PSPACE$. A problem Π is **PSPACE-hard** if, for any problem Π' that can be solved using polynomial *space*, there is a polynomial-*time* many-one reduction from Π' to Π . If any PSPACE-hard problem is in NP, then $PSPACE=NP$; similarly, if any PSPACE-hard problem is in P, then $PSPACE=P$.

The canonical PSPACE-hard problem is the *quantified boolean formula* problem, or **QBF**: Given a boolean formula Φ that may include any number of universal or existential quantifiers, but no free variables, is Φ equivalent to TRUE? For example, the following expression is a valid input to QBF:

$$\exists a: \forall b: \exists c: (\forall d: a \vee b \vee c \vee \bar{d}) \Leftrightarrow ((b \wedge \bar{c}) \vee (\exists e: \overline{(\bar{a} \Rightarrow e)} \vee (c \neq a \wedge e))).$$

SAT is equivalent to the special case of QBF where the input formula contains only existential quantifiers. QBF remains PSPACE-hard even when the input formula must have all its quantifiers at the beginning, the quantifiers strictly alternate between \exists and \forall , and the quantified proposition is in conjunctive normal form, with exactly three literals in each clause, for example:

$$\exists a: \forall b: \exists c: \forall d: ((a \vee b \vee c) \wedge (b \vee \bar{c} \vee \bar{d}) \wedge (\bar{a} \vee c \vee d) \wedge (a \vee \bar{b} \vee \bar{d}))$$

This restricted version of QBF can also be phrased as a two-player strategy question. Suppose two players, Alice and Bob, are given a 3CNF predicate with free variables x_1, x_2, \dots, x_n . The players alternately assign values to the variables in order by index—Alice assigns a value to x_1 , Bob assigns a value to x_2 , and so on. Alice eventually assigns values to every variable with an odd index, and Bob eventually assigns values to every variable with an even index. Alice wants to make the expression TRUE, and Bob wants to make it FALSE. Assuming Alice and Bob play perfectly, who wins this game? Not surprisingly, most two-player games¹⁹ like tic-tac-toe, reversi, checkers, go, chess, and

¹⁹For a good (but now slightly dated) overview of known results on the computational complexity of games and puzzles, see Erik D. Demaine and Robert Hearn's survey "Playing Games with Algorithms: Algorithmic Combinatorial Game Theory" at <http://arxiv.org/abs/cs.CC/0106019>.

mancala—or more accurately, appropriate generalizations of these constant-size games to arbitrary board sizes—are PSPACE-hard.

Another canonical PSPACE-hard problem is *NFA totality*: Given a non-deterministic finite-state automaton M over some alphabet Σ , does M accept every string in Σ^* ? The closely related problems *NFA equivalence* (Do two given NFAs accept the same language?) and *NFA minimization* (Find the smallest NFA that accepts the same language as a given NFA) are also PSPACE-hard, as are the corresponding questions about regular expressions. (The corresponding questions about *deterministic* finite-state automata are all solvable in polynomial time.)

Exponential Time

The next significantly larger complexity class, **EXP** (also called EXPTIME), is the set of decision problems that can be solved in exponential time, that is, using at most 2^{n^c} steps for some constant $c > 0$. Every problem in PSPACE (and therefore in NP (and therefore in P)) is also in EXP. It is generally believed that $\text{PSPACE} \subsetneq \text{EXP}$, but nobody can even prove that $\text{NP} \neq \text{EXP}$. A problem Π is **EXP-hard** if, for any problem Π' that can be solved in exponential time, there is a polynomial-time many-one reduction from Π' to Π . If any EXP-hard problem is in PSPACE, then $\text{EXP} = \text{PSPACE}$; similarly, if any EXP-hard problem is in NP, then $\text{EXP} = \text{NP}$. We *do* know that $\text{P} \neq \text{EXP}$; in particular, no EXP-hard problem is in P.

Natural generalizations of many interesting 2-player games—like checkers, chess, mancala, and go—are actually EXP-hard. The boundary between PSPACE-hard games and EXP-hard games is rather subtle. For example, there are three ways to draw in chess (the standard 8×8 game): stalemate (the player to move is not in check but has no legal moves), repeating the same board position three times, or moving fifty times without capturing a piece. The $n \times n$ generalization of chess is either in PSPACE or EXP-hard depending on how we generalize these rules. If we declare a draw after (say) n^3 capture-free moves, then every game must end after a polynomial number of moves, so we can simulate all possible games from any given position using only polynomial space. On the other hand, if we ignore the capture-free move rule entirely, the resulting game can last an exponential number of moves, so there no obvious way to detect a repeating position using only polynomial space; indeed, this version of $n \times n$ chess is EXP-hard.

Excelsior!

Naturally, even exponential time is not the end of the story. **NEXP** is the class of decision problems that can be solve in *nondeterministic* exponential time; equivalently, a decision problem is in NEXP if and only if, for every YES instance, there is a *proof* of this fact that can be checked in exponential time. **EXPSpace** is the set of decision problems that can be solved using exponential *space*. Even these larger complexity classes have

hard problems; for example, if we add the intersection operator \cap to the syntax of regular expressions, deciding whether two such expressions describe the same language is EXPSPACE-hard. Beyond EXPSPACE are complexity classes with *doubly*-exponential resource bounds (EEXP, NEXP, and EEXPSPACE), then *triply* exponential resource bounds (EEEXP, NEEEXP, and EEEXPSPACE), and so on ad infinitum.

All these complexity classes can be ordered by inclusion:

$$P \subseteq NP \subseteq PSPACE \subseteq EXP \subseteq NEXP \subseteq EXPSPACE \subseteq EEXP \subseteq NEXP \subseteq EEEXPSPACE \subseteq \dots$$

Most complexity theorists strongly believe that every inclusion in this sequence is strict; that is, no two of these complexity classes are equal. However, the strongest result that has been proved is that every class in this sequence is strictly contained in the class *three* steps later in the sequence. For example, we have proofs that $P \neq EXP$ and $PSPACE \neq EXPSPACE$, but not whether $P \neq PSPACE$ or $NP \neq EXP$.

The limit of this series of increasingly exponential complexity classes is the class **ELEMENTARY** of decision problems that can be solved using time or space bounded by a function the form $2 \uparrow^k n$ for some constant integer k , where

$$2 \uparrow^k n := \begin{cases} n & \text{if } k = 0, \\ 2^{2 \uparrow^{k-1} n} & \text{otherwise.} \end{cases}$$

For example, $2 \uparrow^1 n = 2^n$ and $2 \uparrow^2 n = 2^{2^n}$.

It may be tempting to conjecture that every natural decidable problem can be solved in elementary time, but in fact this conjecture is incorrect. Consider the **extended regular expressions** defined by recursively combining (possibly empty) strings over some finite alphabet by concatenation (xy), union ($x + y$), Kleene closure (x^*), and negation (\bar{x}). For example, the extended regular expression $(\bar{0} + 1)^* 00 (\bar{0} + 1)^*$ represents the set of strings in $\{0, 1\}^*$ that do *not* contain two 0s in a row. It is possible to determine algorithmically whether two extended regular expressions describe identical languages, by recursively converting each expression into an equivalent NFA, converting each NFA into a DFA, and then minimizing the DFA. However, the running time of this algorithm has the non-elementary bound $2 \uparrow^{\Theta(n)} 2$, intuitively because each layer of recursive negation can increase the number of states exponentially. In fact, this problem provably *cannot* be solved in only elementary time, even if we forbid Kleene closure!²⁰

Exercises

- (a) Describe and analyze an algorithm to solve PARTITION in time $O(nM)$, where n is the size of the input set and M is the sum of the absolute values of its elements.

²⁰Larry J. Stockmeyer. *The Complexity of Decision Problems in Automata Theory and Logic*. Ph.D. thesis, MIT, 1974.

- (b) Why doesn't this algorithm imply that $P=NP$?
2. Consider the following problem, called **BoxDEPTH**: Given a set of n axis-aligned rectangles in the plane, how big is the largest subset of these rectangles that contain a common point?
- (a) Describe a polynomial-time reduction from **BoxDEPTH** to **MaxCLIQUE**.
- (b) Describe and analyze a polynomial-time algorithm for **BoxDEPTH**. [Hint: $O(n^3)$ time should be easy, but $O(n \log n)$ time is possible.]
- (c) Why don't these two results imply that $P=NP$?
3. A boolean formula is in *disjunctive normal form* (or *DNF*) if it consists of a *disjunction* (OR) or several *terms*, each of which is the *conjunction* (AND) of one or more literals. For example, the formula

$$(\bar{x} \wedge y \wedge \bar{z}) \vee (y \wedge z) \vee (x \wedge \bar{y} \wedge \bar{z})$$

is in disjunctive normal form. **DNF-SAT** asks, given a boolean formula in disjunctive normal form, whether that formula is satisfiable.

- (a) Describe a polynomial-time algorithm to solve **DNF-SAT**.
- (b) What is the error in the following argument that $P=NP$?

Suppose we are given a boolean formula in conjunctive normal form with at most three literals per clause, and we want to know if it is satisfiable. We can use the distributive law to construct an equivalent formula in disjunctive normal form. For example,

$$(x \vee y \vee \bar{z}) \wedge (\bar{x} \vee \bar{y}) \iff (x \wedge \bar{y}) \vee (y \wedge \bar{x}) \vee (\bar{z} \wedge \bar{x}) \vee (\bar{z} \wedge \bar{y})$$

Now we can use the algorithm from part (a) to determine, in polynomial time, whether the resulting DNF formula is satisfiable. We have just solved $3SAT$ in polynomial time. Since $3SAT$ is NP-hard, we must conclude that $P=NP$!

4. (a) Describe a polynomial-time reduction from **PARTITION** to **SUBSETSUM**.
- (b) Describe a polynomial-time reduction from **SUBSETSUM** to **PARTITION**.
5. (a) Describe a polynomial-time reduction from **UNDIRECTEDHAMILTONIANCYCLE** to **DIRECTEDHAMILTONIANCYCLE**.
- (b) Describe a polynomial-time reduction from **DIRECTEDHAMILTONIANCYCLE** to **UNDIRECTEDHAMILTONIANCYCLE**.
6. (a) Describe a polynomial-time reduction from **HAMILTONIANPATH** to **HAMILTONIANCYCLE**.

- (b) Describe a polynomial-time reduction from HAMILTONIANCYCLE to HAMILTONIAN-PATH. [Hint: A polynomial-time reduction may call the black-box subroutine more than once.]
7. (a) Prove that PLANARCIRCUITSAT is NP-hard. [Hint: Construct a gadget for crossing wires.]
- (b) Prove that NOTALLEQUAL3SAT is NP-hard.
- (c) Prove that 1-IN-3SAT is NP-hard.
- (d) Prove that the following variant of 3SAT is NP-hard: Given a boolean formula Φ in conjunctive normal form where each clause contains at most 3 literals and each variable appears in at most 3 clauses, does Φ have a satisfying assignment?
8. (a) Using the gadget in Figure 10.23(a), prove that deciding whether a given planar graph is 3-colorable is NP-hard. [Hint: Show that the gadget can be 3-colored, and then replace any crossings in a planar embedding with the gadget appropriately.]
- (b) Using part (a) and the gadget in Figure 10.23(b), prove that deciding whether a planar graph with maximum degree 4 is 3-colorable is NP-hard. [Hint: Replace any vertex with degree greater than 4 with a collection of gadgets connected so that no degree is greater than four.]

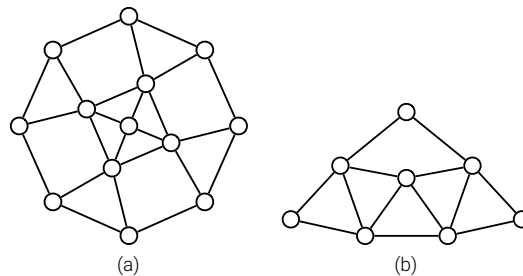

Figure 10.23. (a) Gadget for planar 3-colorability. (b) Gadget for degree-4 planar 3-colorability.

9. Prove that the following problems are NP-hard.
- (a) Given an undirected graph G , does G contain a simple path that visits all but 17 vertices?
- (b) Given an undirected graph G , does G have a spanning tree in which every node has degree at most 23?
- (c) Given an undirected graph G , does G have a spanning tree with at most 42 leaves?
- (d) Given an undirected graph $G = (V, E)$, what is the size of the largest subset of vertices $S \subseteq V$ such that at most 473 edges in E have both endpoints in S ?
- (e) Given an undirected graph G , is it possible to color the vertices of G with three different colors, so that at most 31337 edges have both endpoints the same color?

10. Prove that the following variants of the minimum spanning tree problem are NP-hard.
 - (a) Given a graph G , compute the *maximum-diameter* spanning tree of G . (The diameter of a spanning tree T is the length of the longest path in T .)
 - (b) Given a graph G with weighted edges, compute the minimum-weight *depth-first* spanning tree of G .
 - (c) Given a graph G with weighted edges and a subset S of vertices of G , compute the minimum-weight spanning tree all of whose leaves are in S .
 - (d) Given a graph G with weighted edges and an integer ℓ , compute the minimum-weight spanning tree with at most ℓ leaves.
 - (e) Given a graph G with weighted edges and an integer Δ , compute the minimum-weight spanning tree where every node has degree at most Δ .

11. **There's something special about the number 3.**
 - (a) Describe and analyze a polynomial-time algorithm for 2PARTITION. Given a set S of $2n$ positive integers, your algorithm will determine in polynomial time whether the elements of S can be split into n disjoint pairs whose sums are all equal.
 - (b) Describe and analyze a polynomial-time algorithm for 2COLOR. Given an undirected graph G , your algorithm will determine in polynomial time whether G has a proper coloring that uses only two colors.
 - (c) Describe and analyze a polynomial-time algorithm for 2SAT. Given a boolean formula Φ in conjunctive normal form, with exactly *two* literals per clause, your algorithm will determine in polynomial time whether Φ has a satisfying assignment.

12. **There's nothing special about the number 3.**
 - (a) The problem 12PARTITION is defined as follows: Given a set S of $12n$ positive integers, determine whether the elements of S can be split into n subsets of 12 elements each whose sums are all equal. Prove that 12PARTITION is NP-hard. [*Hint: Reduce from 3PARTITION. It may be easier to consider multisets first.*]
 - (b) The problem 12COLOR is defined as follows: Given an undirected graph G , determine whether we can color each vertex with one of twelve colors, so that every edge touches two different colors. Prove that 12COLOR is NP-hard. [*Hint: Reduce from 3COLOR.*]
 - (c) The problem 12SAT is defined as follows: Given a boolean formula Φ in conjunctive normal form, with exactly twelve literals per clause, determine whether Φ has a satisfying assignment. Prove that 12SAT is NP-hard. [*Hint: Reduce from 3SAT.*]

13. Describe a direct polynomial-time reduction from 4COLOR to 3COLOR. (This is a lot harder than the opposite direction.)

14. *Pebbling* is a solitaire game played on an undirected graph G , where each vertex has zero or more *pebbles*. A single *pebbling move* consists of removing two pebbles from a vertex v and adding one pebble to an arbitrary neighbor of v . (Obviously, the vertex v must have at least two pebbles before the move.) The PEBBLEDESTRUCTION problem asks, given a graph $G = (V, E)$ and a pebble count $p(v)$ for each vertex v , whether there is a sequence of pebbling moves that removes all but one pebble. Prove that PEBBLEDESTRUCTION is NP-hard.
15. Recall that a 5-coloring of a graph G is a function that assigns each vertex of G a “color” from the set $\{0, 1, 2, 3, 4\}$, such that for any edge uv , vertices u and v are assigned different “colors”. A 5-coloring is *careful* if the colors assigned to adjacent vertices are not only distinct, but differ by more than 1 (mod 5). Prove that deciding whether a given graph has a careful 5-coloring is NP-hard. [Hint: Reduce from the standard 5COLOR problem.]

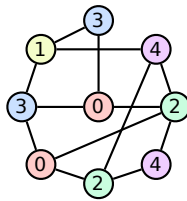

Figure 10.24. A careful 5-coloring.

16. A subset S of vertices in an undirected graph G is called *triangle-free* if, for every triple of vertices $u, v, w \in S$, at least one of the three edges uv, vw, wu is *absent* from G . Prove that finding the size of the largest triangle-free subset of vertices in a given undirected graph is NP-hard.

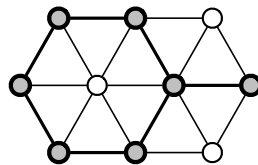

Figure 10.25. A triangle-free subset of 7 vertices. This is not the largest triangle-free subset in this graph.

17. Let $G = (V, E)$ be a graph. A *dominating set* in G is a subset S of the vertices such that every vertex in G is either in S or adjacent to a vertex in S . The DOMINATINGSET problem asks, given a graph G and an integer k as input, whether G contains a dominating set of size k . Prove that this problem is NP-hard.

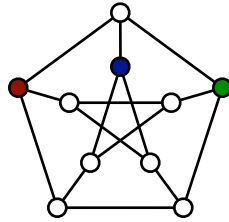

Figure 10.26. A dominating set of size 3 in the Peterson graph.

18. The RECTANGLE TILING problem is defined as follows: Given one large rectangle and several smaller rectangles, determine whether the smaller rectangles can be placed inside the large rectangle with no gaps or overlaps.
- (a) Prove that RECTANGLE TILING is NP-hard.
 - (b) Prove that RECTANGLE TILING is *strongly* NP-hard.

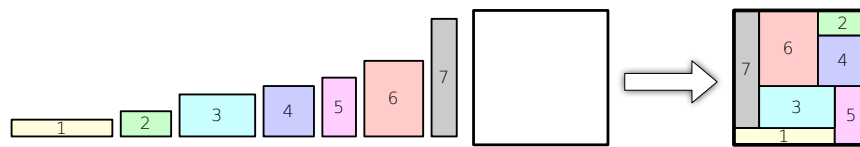
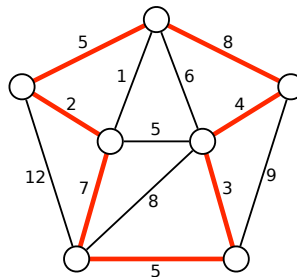

Figure 10.27. A positive instance of the RECTANGLE TILING problem.

19. Let G be an undirected graph with weighted edges. A *heavy Hamiltonian cycle* is a cycle C that passes through each vertex of G exactly once, such that the total weight of the edges in C is at least half of the total weight of all edges in G . Prove that deciding whether a graph has a heavy Hamiltonian cycle is NP-hard.



A heavy Hamiltonian cycle. The cycle has total weight 34; the graph has total weight 67.

- 20. (a) A *tonian path* in a graph G is a path that goes through at least half of the vertices of G . Show that determining whether a graph has a tonian path is NP-hard.
- (b) A *tonian cycle* in a graph G is a cycle that goes through at least half of the vertices of G . Show that determining whether a graph has a tonian cycle is NP-hard. [Hint: Use part (a).]

21. This exercise asks you to prove that a certain reduction from VERTEXCOVER to STEINERTREE is correct. Suppose we want to find the smallest vertex cover in a given undirected graph $G = (V, E)$. We construct a new graph $H = (V', E')$ as follows:

- $V' = V \cup E \cup \{z\}$
- $E' = \{ve \mid v \in V \text{ is an endpoint of } e \in E\} \cup \{vz \mid v \in V\}$.

Equivalently, we construct H by subdividing each edge in G with a new vertex, and then connecting all the original vertices of G to a new *apex* vertex z .

Prove that G has a vertex cover of size k if and only if there is a subtree of H with $k + |E| + 1$ vertices that contains every vertex in $E \cup \{z\}$.

22. For each problem below, either describe a polynomial-time algorithm or prove that the problem is NP-hard.
- (a) A *double-Eulerian tour* in an undirected graph G is a closed walk that traverses every edge in G exactly twice. Given a graph G , does G have a double-Eulerian tour?
 - (b) A *double-Hamiltonian tour* in an undirected graph G is a closed walk that visits every vertex in G exactly twice. Given a graph G , does G have a double-Hamiltonian tour?
 - (c) A *double-Hamiltonian circuit* in an undirected graph G is a closed walk that visits every vertex in G exactly twice *and traverses each edge in G at most once*. Given a graph G , does G have a double-Hamiltonian circuit?
 - (d) A *triple-Eulerian tour* in an undirected graph G is a closed walk that traverses every edge in G exactly three times. Given a graph G , does G have a triple-Eulerian tour?
 - (e) A *triple-Hamiltonian tour* in an undirected graph G is a closed walk that visits every vertex in G exactly three times. Given a graph G , does G have a triple-Hamiltonian tour?

23. Consider the following solitaire game. The puzzle consists of an $n \times m$ grid of squares, where each square may be empty, occupied by a red stone, or occupied by a blue stone. The goal of the puzzle is to remove some of the given stones so that the remaining stones satisfy two conditions: (1) every row contains at least one stone, and (2) no column contains stones of both colors. For some initial configurations of stones, reaching this goal is impossible.

Prove that it is NP-hard to determine, given an initial configuration of red and blue stones, whether the puzzle can be solved.

24. A boolean formula in *exclusive-or conjunctive normal form* (XCNF) is a conjunction (AND) of several *clauses*, each of which is the *exclusive-or* of several literals; that is, a clause is true if and only if it contains an odd number of true literals. The

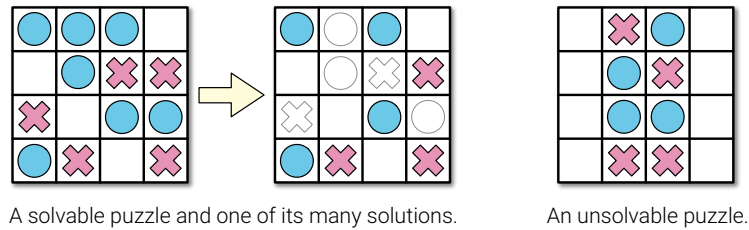

A solvable puzzle and one of its many solutions.

An unsolvable puzzle.

XCNF-SAT problem asks whether a given XCNF formula is satisfiable. Either describe a polynomial-time algorithm for XCNF-SAT or prove that it is NP-hard.

25. Jeff tries to make his students happy. At the beginning of class, he passes out a questionnaire that lists a number of possible course policies in areas where he is flexible. Every student is asked to respond to each possible course policy with one of “strongly favor”, “mostly neutral”, or “strongly oppose”. Each student may respond with “strongly favor” or “strongly oppose” to at most five questions. Because Jeff’s students are very understanding, each student is happy if (but only if) he or she prevails in just one of his or her strong policy preferences. Either describe a polynomial-time algorithm for setting course policy to maximize the number of happy students, or show that the problem is NP-hard.

26. You’re in charge of choreographing a musical for your local community theater, and it’s time to figure out the final pose of the big show-stopping number at the end. (“Streetcar!”) You’ve decided that each of the n cast members in the show will be positioned in a big line when the song finishes, all with their arms extended and showing off their best spirit fingers.

The director has declared that during the final flourish, each cast member must either point both their arms up or point both their arms down; it’s your job to figure out who points up and who points down. Moreover, in a fit of unchecked power, the director has also given you a list of arrangements that will upset his delicate artistic temperament. Each forbidden arrangement is a subset of the cast members paired with arm positions; for example: “Marge may not point her arms up while Ned, Apu, and Smithers point their arms down.”

Prove that finding an acceptable arrangement of arm positions is NP-hard.

27. The next time you are at a party, one of the guests will suggest everyone play a round of Three-Way Mumbledypeg, a game of skill and dexterity that requires three teams and a knife. The official Rules of Three-Way Mumbledypeg (fixed during the Holy Roman Three-Way Mumbledypeg Council in 1625) require that (1) each team *must* have at least one person, (2) any two people on the same team *must* know each other, and (3) everyone watching the game *must* be on one of the three teams. Of course, it will be a really *fun* party; nobody will want to leave. There will be several

pairs of people at the party who don't know each other. The host of the party, having heard thrilling tales of your prowess in all things algorithmic, will hand you a list of which pairs of party-goers know each other and ask you to choose the teams, while he sharpens the knife.

Either describe and analyze a polynomial time algorithm to determine whether the party-goers can be split into three legal Three-Way Mumbledypeg teams, or prove that the problem is NP-hard.

28. The party you are attending is going great, but now it's time to line up for *The Algorithm March* (アルゴリズムこうしん)! This dance was originally developed by the Japanese comedy duo Itsumo Kokokara (いつもここから) for the children's television show PythagoraSwitch (ピタゴラスイッチ). The Algorithm March is performed by a line of people; each person in line starts a specific sequence of movements one measure later than the person directly in front of them. Thus, the march is the dance equivalent of a musical round or canon, like "Row Row Row Your Boat".

Proper etiquette dictates that each marcher must know the person directly in front of them in line, lest a minor mistake during lead to horrible embarrassment between strangers. Suppose you are given a complete list of which people at your party know each other. **Prove** that it is NP-hard to determine the largest number of party-goers that can participate in the Algorithm March. You may assume without loss of generality that there are no ninjas at your party.

29. Charon needs to ferry n recently deceased people across the river Acheron into Hades. Certain pairs of these people are sworn enemies, who cannot be together on either side of the river unless Charon is also present. (If two enemies are left alone, one will steal the obol from the other's mouth, leaving them to wander the banks of the Acheron as a ghost for all eternity. Let's just say this is a Very Bad Thing.) The ferry can hold at most k passengers at a time, including Charon, and only Charon can pilot the ferry.

Prove that it is NP-hard to decide whether Charon can ferry all n people across the Acheron unharmed.²¹ The input for Charon's problem consists of the integers k and n and an n -vertex graph G describing the pairs of enemies. The output is either TRUE or FALSE.

30. (a) Suppose you are given a magic black box that can determine **in polynomial time**, given an arbitrary weighted graph G , the length of the shortest Hamiltonian cycle in G . Describe and analyze a **polynomial-time** algorithm that computes, given an arbitrary weighted graph G , the shortest Hamiltonian cycle in G , using this magic black box as a subroutine.

²¹Aside from being, you know, dead.

- (b) Suppose you are given a magic black box that can determine **in polynomial time**, given an arbitrary graph G , the number of vertices in the largest complete subgraph of G . Describe and analyze a **polynomial-time** algorithm that computes, given an arbitrary graph G , a complete subgraph of G of maximum size, using this magic black box as a subroutine.
- (c) Suppose you are given a magic black box that can determine **in polynomial time**, given an arbitrary graph G , whether G is 3-colorable. Describe and analyze a **polynomial-time** algorithm that either computes a proper 3-coloring of a given graph or correctly reports that no such coloring exists, using the magic black box as a subroutine. [Hint: The input to the magic black box is a graph. Just a graph. Vertices and edges. Nothing else.]
- (d) Suppose you are given a magic black box that can determine **in polynomial time**, given an arbitrary boolean formula Φ , whether Φ is satisfiable. Describe and analyze a **polynomial-time** algorithm that either computes a satisfying assignment for a given boolean formula or correctly reports that no such assignment exists, using the magic black box as a subroutine.
- (e) Suppose you are given a magic black box that can determine **in polynomial time**, given an arbitrary set X of positive integers, whether X can be partitioned into two sets A and B such that $\sum A = \sum B$. Describe and analyze a **polynomial-time** algorithm that either computes an equal partition of a given set of positive integers or correctly reports that no such partition exists, using the magic black box as a subroutine.

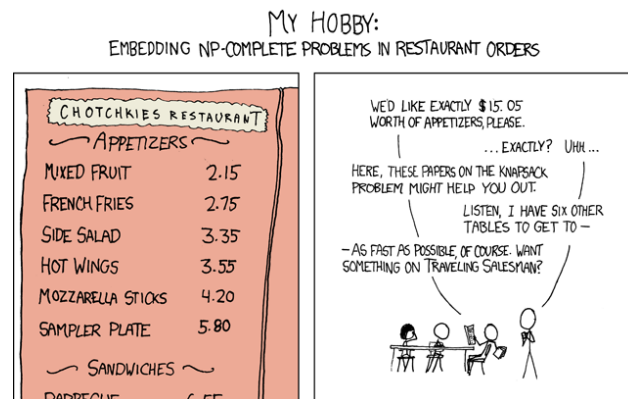

[General solutions give you a 50% tip.]

— Randall Munroe, xkcd (<http://xkcd.com/287/>)

Reproduced under a Creative Commons Attribution-NonCommercial 2.5 License

© Copyright 2016 Jeff Erickson.

This work is licensed under a Creative Commons License (<http://creativecommons.org/licenses/by-nc-sa/4.0/>).

Free distribution is strongly encouraged; commercial distribution is expressly forbidden.

See <http://jeffe.cs.illinois.edu/teaching/algorithms/> for the most recent revision.